



METEOROLOGICAL INSTRUMENTS

INSTRUCTIONS

**WIND TRACKER
MODEL 06201**



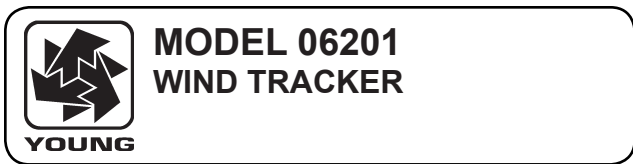

FRONT PANEL

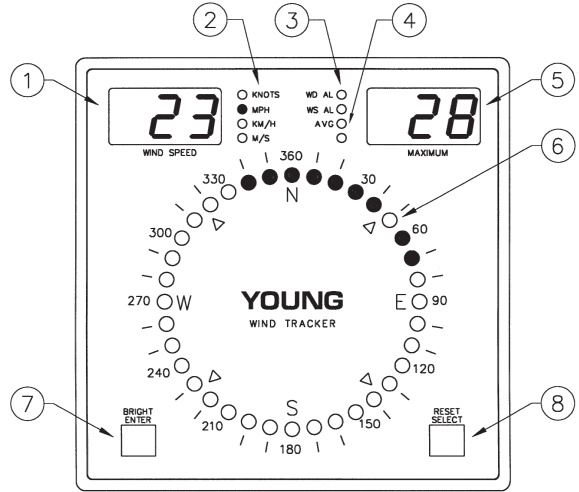

1. Wind Speed Display
2. Wind Speed Units Indicator
3. Alarm Status Indicators
4. Data Averaging Indicator
5. Maximum Wind Speed or Direction Display
6. Wind Direction and Variability Display
7. Brightness Control and Enter key (setup only)
8. Maximum Reset and Select key (setup only)

INTRODUCTION

The YOUNG Model 06201 Wind Tracker is a compact wind speed and direction display. This model has advanced features including 4-20 mA inputs, serial input/output and alarms.

FEATURES

- 3 digit wind speed display
- 3 digit maximum wind speed or wind direction display
- Multi-color wind direction display with variability display
- Wind speed and direction alarms with delay
- RS-485 serial connections for up to 16 displays
- Calibrated 0-5 VDC outputs
- Display brightness control
- 4-20 mA Sensor Inputs

PRECAUTIONS

- INDOOR USE ONLY unless placed in approved enclosure
- Operating temperature range 0-50°C (32-122°F), 0-95% RH
- Use only recommended power sources. 12-30 VDC, 4.5 W
- Disconnect power when connecting or servicing sensors and external devices
- Maximum 24 VAC/30 VDC on alarm relay contacts.

BACK PANEL

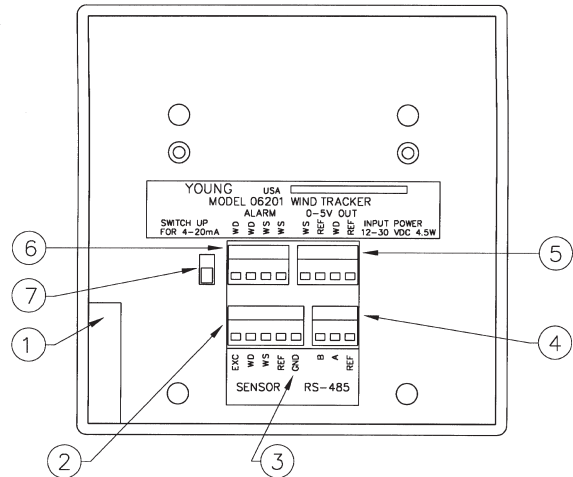

1. Power input (12-30 VDC)
2. Sensor or 4-20 mA inputs
3. Earth ground connection
4. RS-485 serial input/output
5. 0-5 VDC calibrated outputs
6. Alarm relay connections (N.O.)
7. Input selector switch

MOUNTING AND START-UP

1. Select location for display. A location out of direct sunlight provides best visibility.

The Wind Tracker may be mounted from a bulkhead or installed in a flush panel by removing the mounting bracket. Panel cutout dimensions are given in the specifications. An optional rack mounting panel (Model 06280) and protective enclosure (Model 06260) are available from your YOUNG supplier.

2. Connect cables to terminals. Refer to diagram on page 5.
Selector switch on back panel should be DOWN for normal sensor inputs, UP for 4-20 mA inputs or for use with Wind Monitor-SE.
3. Connect GND terminal to suitable earth ground.
4. Insert power supply plug into power jack, plug into standard AC wall outlet.
5. The Wind Tracker will display a software version number for approximately 4 seconds. It will then begin to display wind information. The following information is displayed:
 - Wind Speed
 - Wind Speed Units
 - Maximum Wind Speed or Direction degrees
 - Wind Direction (single orange indicator)
 - Direction Variability (green indicators)
 - WS, WD Alarm Status Indicators (If selected)
 - Data Averaging Indicator (If selected)
6. Observe the unit for a few minutes to verify that it is operating properly. If you wish to change settings (ie: wind speed units), this is done easily using the keys on the front panel.

CHANGING SETTINGS

The Wind Tracker has a SETUP mode that allows you to easily change sensor type, wind speed units, averaging time, alarm settings, and other functions.

Press and hold **ENTER** and **SELECT** keys (about 5 seconds). The display will briefly flash "SEt uP", then begin the SETUP sequence. Change settings with the **SELECT** key. Press the **ENTER** key to save a setting and move to the next step. Abbreviations in the left and right display windows identify each function and the available selections.

DISPLAY		SETUP FUNCTION
LEFT	RIGHT	Input/Sensor Type
InP	LDi	Line Driver 4-20mA input
	03	Wind Sentry
	04	Wind Monitor-Jr
	05	Wind Monitor
	05A	Wind Monitor-AQ
	09	Wind Monitor-SE
	SEr	Serial input for remote display only <i>If SEr is selected, SETUP sequence ends here.</i>
		Wind Speed Units
SPd	unt	Press SELECT to change units, ENTER to proceed.
		Display Averaging
dSP	no	No averaging. Instantaneous data displayed.
	YES	Display averaging in effect. <i>If no is selected, the following step does not appear.</i>
PEr	030	Set averaging period in seconds (0-999). Display will update at this interval.

dSP	SPd	Displays MAXIMUM wind speed in right display.
	dir	Displays Wind Direction degrees (1° resolution) in right display.
		Wind Direction Alarm
ALr	no	WD alarm not used.
	YES	WD alarm activated. <i>If no is selected, the following 2 steps do not appear.</i>
ALr	dir	Press SELECT to position alarm sector. Press ENTER.
ALr	SPn	Press SELECT to set size (span) of alarm sector.
		Wind Speed Alarm
ALr	no	WS alarm not used.
	YES	WS alarm activated. <i>If no is selected, the following step does not appear.</i>
ALr	000	WS alarm set point. Press SELECT to change digits. ENTER to save.
		Alarm Delay Time
		<i>If no alarm is selected, this step does not appear.</i>
dLY	030	Set alarm delay time in seconds (0-999).
		Sound
Snd	no	No sound with alarm or average update.
	YES	Audible beeper will sound with alarm or avg update.
		Test Functions
tSt	ALr	Press SELECT to close alarm relays.
CAL	0.00	Press SELECT to alternate between 0.00 VDC and 5.00 VDC at "0-5V OUT" terminals. Use to calibrate external devices (recorders, etc..)

ADDITIONAL INFORMATION

ALARMS

Wind speed and wind direction alarm functions are accessed in the SETUP sequence. Either or both alarms may be used. When activated, alarms are indicated on the front panel. When an alarm condition exists, the indicator blinks, the associated relay contact closes and beeper sounds (if selected). When a delay time is set, the indicator will not report an alarm condition until it has existed for one complete delay period. Alarm activity ceases when conditions are outside the alarm range for one complete delay period. For a "latching" alarm effect, use the Wind Tracker alarm contacts to activate an appropriate external latching-type relay.

AVERAGING

The Wind Tracker can display instantaneous or averaged wind data. Averaging is selected in the SETUP sequence at the prompt "dSP". The average is a block average for the time period selected. The display updates only after each time period has elapsed and will hold this information until the next update.

BRIGHTNESS

Adjust display brightness by holding the BRIGHT key.

MAXIMUM/WIND DIRECTION DIGITAL DISPLAY

The right display window can show either MAXIMUM WIND SPEED or Numerical WIND DIRECTION. This selection is made in the setup mode under Display (dSP).

REMOTE DISPLAYS

The Wind Tracker can be used as a remote display by selecting "InP SEr" during SETUP. Remote displays are connected to the main display using the RS-485 terminals. Connect like terminals as shown in wiring diagrams. Remote displays show exactly the same information as the main unit. MAX RESET and SETUP features are controlled at the main unit only. Brightness can be adjusted at each display independently. Up to 16 remote displays can be connected to one main display.

VOLTAGE OUTPUTS

The Wind Tracker offers calibrated voltage outputs for both wind speed and wind direction. This feature allows the use of recorders and other devices. Full scale voltage for each channel is 5.00 VDC.

4-20 mA INPUTS

The Wind Tracker accepts 4-20 mA (Line Driver) inputs. The Line Driver circuit must provide 0 - 50 M/S Wind Speed scaling ("M" suffix). Connect cable as indicated on page 4. Switch on back must be UP at power up for correct 4-20 mA operation. Set INPUT to "LDI" in SETUP. Note: 24 VDC power is required for line driver applications.

ERROR MESSAGES

The Wind Tracker detects and indicates two errors. Once corrected, the error indication disappears.

DISPLAY

LDi	Err	4-20 mA (line driver) signal is missing or outside of acceptable range. Verify proper switch position or signal.
SEr	Err	Unit is set to receive RS-485 serial signal, (InP SEr) but no serial data is coming in. Verify that the serial source is operating. Check cables for proper connection.

WARRANTY

The Wind Tracker is warranted to be free of defects in materials and construction for a period of 12 months from date of purchase. Coverage is limited to repair or replacement of defective unit.

SPECIFICATIONS

Size: 144 mm (5.65 in) x 144 mm (5.65 in) x 36 mm (1.4 in)

Panel Cutout: 138 mm (5.43 in) x 138 mm (5.43 in)

Compatible Sensors:

- Wind Monitor
- Wind Monitor-SE
- Wind Monitor-MA

Wind Monitor-AQ

Wind Monitor-JR

Wind Sentry

Other Inputs: RS-485, 4-20 mA

Accuracy: ±0.6% F.S.

Display Resolution:

Wind Direction: 10° circular pattern (36 points)
1° digital w/ **dSP dlr** selected

Wind Speed &

Maximum: 1 Knot, 1 MPH, 1 KM/H, 0.1 M/S

Voltage Outputs:

Wind Direction Range:

0-5 VDC 0-360°

Wind Speed Range: (dependent on units selected)

0-5 VDC 0-100 Knots

0-100 MPH

0-200 KM/H

0-50 M/S

Alarm Relays: Non-latching

Normally Open contacts for WS and WD.

Contact rating 5A resistive,

2A inductive @ 24 VAC, 30 VDC.

Input Power: 12-30 VDC, 4.5 W

Weight: 1.0 lb (0.45 kg) without AC adapter

CE COMPLIANCE

This product has been tested and shown to comply with European CE requirements for the EMC Directive. Please note that shielded cable must be used.

Declaration of Conformity

R. M. Young Company
2801 Aero Park Drive
Traverse City, MI 49686 USA

Model 06201 WIND TRACKER

The undersigned hereby declares on behalf of R. M. Young Company that the above-referenced product, to which this declaration relates, is in conformity with the provisions of:

Council Directive 2004/108/EC (December 15, 2004)
on Electromagnetic Compatibility



David Poinsett
R&D Manager



WIND TRACKER WIRING DIAGRAMS

NOTE: EARTH GROUND CONNECTION TO GROUND TERMINAL OF WIND TRACKER REQUIRED.

WIND SENSOR
05103, 05305
04101, 03002

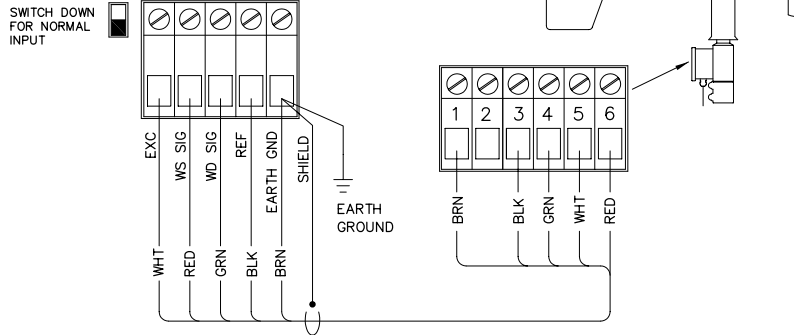

WIND SENSOR
05106, 04106

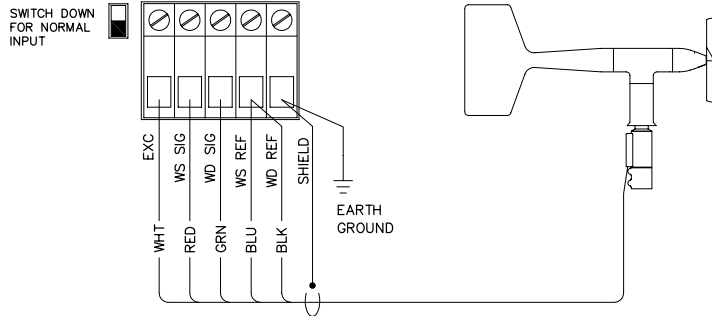

WIND SENSOR
05103LM, 05305LM
04101LM, 03002LM
WITH 4-20mA
OUTPUTS

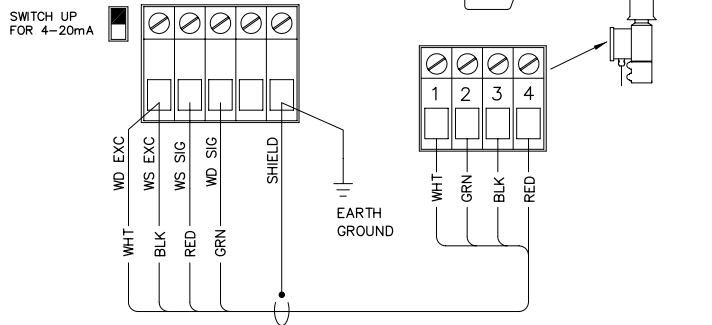

WIND SENSOR
05106, 04106
WITH 4-20mA
LINE DRIVER

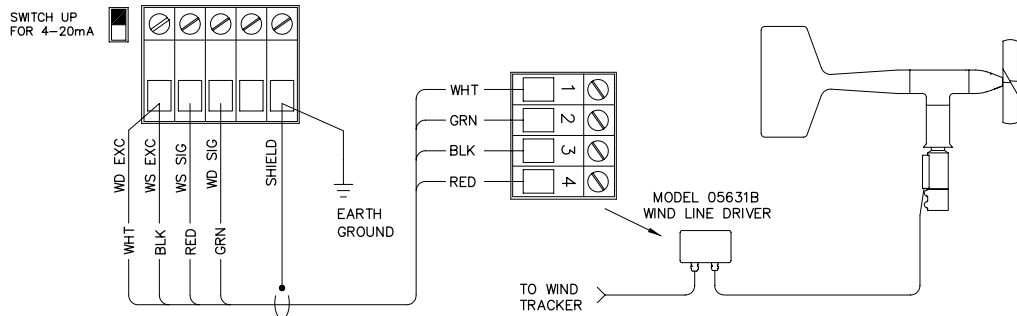



MODEL 09101
WIND MONITOR-SE

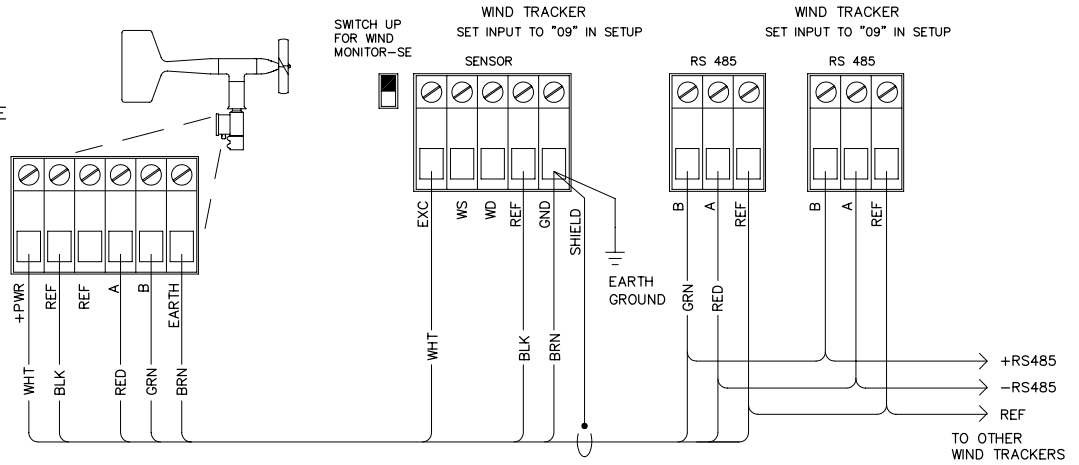

REMOTE
DISPLAYS

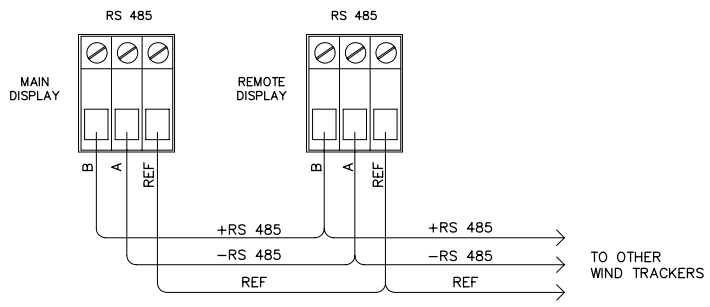

ALARM/RELAY
NON-LATCHING

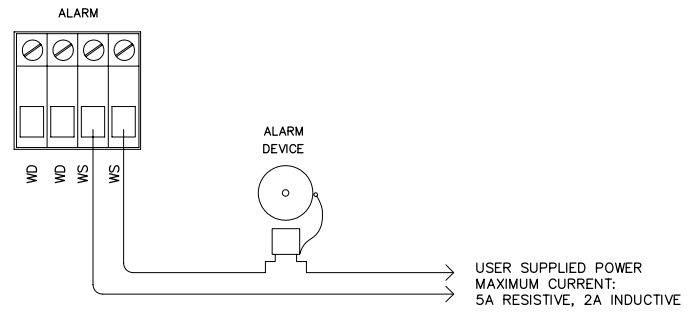

VOLTAGE
OUTPUTS

