



Handheld Pressure Calibrator

ADT273Ex Handheld Pressure Calibrator

User Manual

[Version: 2302V02]

Additel Corporation

STATEMENT

This user manual provides operating and safety instructions for the 273Ex Handheld Pressure Calibrator. To ensure correct operation and safety, please follow the instructions in this manual. Additel Corporation reserves the right to change the contents and other information contained in this manual without notice.

Content

Safety instructions.....	1
Special safety requirements.....	2
Intended use.....	5
1. Introduction.....	6
1.1 Product Overview.....	6
1.2 Technical specification.....	7
1.2.1 General specification.....	7
1.2.2 Signal measure specification (environmental temp.: 20±10°C, 1 year accuracy.....)	9
1.3 Basic Structure.....	10
1.4 Standard Package Contents.....	11
1.5 Power supply description.....	13
2. Overview for display and basic functions.....	14
2.1 Main interface.....	14
2.1.1 Status bar.....	14
2.1.2 Apps list.....	15
2.1.3 Main function guide.....	15
2.2 Control center.....	16
2.2.1 Date and battery.....	16
2.2.2 Diagnostic center and screenshot.....	16
2.2.3 Shortcut settings.....	17
3. Calibrator.....	18
3.1 Electrical Measurement.....	19
3.1.1 Voltage measurement.....	19
3.1.2 Current measurement.....	19
3.1.3 Frequency measurement.....	20

3.1.4 Pulse measurement	20
3.1.5 Switch measurement	20
3.1.6 Filter	21
3.1.7 Scaling	22
3.2 HART Communications	23
3.2.1 Search and connection	24
3.2.2 Setting	25
3.2.3 Diagnosis and service	26
3.2.4 Process variable setting	32
3.3 Pressure measurement	32
3.3.1 Filter	33
3.3.2 Module information	33
4. System settings	34
4.1 Bluetooth communication	34
4.2 Power management	34
4.3 System calibration	34
4.4 Services	35
4.4.1 Maintenance	35
4.4.2 Restore to factory data	35
4.4.3 Running information	35
4.4.4 System upgrade	35
4.5 Personalization	35
4.5.1 Sound	35
4.5.2 Language	36
4.5.3 Date & Time	36
4.6 Product information	36
5. Data management	37
6. Quick test	37
6.1 Dial pressure gauge and digital pressure gauge calibration	38

6.2 Pressure transmitter (voltage, current and HART)	39
6.3 Pressure switch	40
7. Applications	42
7.1 Units converter	42
7.2 Leak test	42
7.2.1 Leak Test Performing	42
7.3 PSV test	43
7.3.1 PSV test performing	43
7.4 Pressure delta	43
7.5 Wiring help	45

Figure Content

Figure 1 Basic Structure.....	10
Figure 2 Adaptor and the power plug	13
Figure 3 Main interface	14
Figure 4 Control center	16
Figure 5 Calibrator main screen	18
Figure 6 Voltage / Frequency / Pulse / Switch Measurement.....	19
Figure 7 Current Measurement	19
Figure 8 Filter settings.....	21
Figure 9 Scaling configurations	23
Figure 10 Internal power + internal resistance	24
Figure 11 External power + external resistance	24
Figure 12 Current loop test	27
Figure 13 PVAO zero	28
Figure 14 D/A adjustment.....	29
Figure 15 Range migration.....	30
Figure 16 Sensor trim Figure	31
Figure 17 Process variable selection	31

Safety instructions

Warning:

To prevent the user from injury, please follow this user manual for use.

To prevent possible fire, electric shock or personal injury, please do as follows:

Normal:

- ◆ Please read the user manual before using the product, especially the Safety Instructions;
- ◆ Please charge the battery when a low battery level is displayed in case of the measurement abnormal;
- ◆ Do not expose the battery to fire or short circuit the battery;
- ◆ Before using the product, please check the appearance of the product for any damage;
- ◆ If the product is damaged or malfunctions, do not use it, and contact Additel;
- ◆ Do not touch the metal part of the probes or test cables during use;
- ◆ Please remove unnecessary probe, cable or other accessories before using the product;
- ◆ Do not use damaged or worn cable.

Attention:

To prevent damage this product or the device under tested, please obey the instruction manual for use

- ◆ Do not use the instrument in a high vibration environment;
- ◆ Use only the Additel power adaptor and designated battery models;
- ◆ In case of working with an external pressure module, refer to the Safety instructions of its manual.



Special safety requirements

1. WARNING – DO NOT OPEN WHEN AN EXPLOSIVE ATMOSPHERE IS PRESENT
2. WARNING – DO NOT CHARGE THE BATTERY IN HAZARDOUS LOCATION
3. WARNING – USE ONLY the approved batteries
4. The equipment needs to be protected from impacts with high impact energy
5. Do not touch the non-metallic enclosure or touch with the insulating materials only
6. The batteries used in the equipment with same manufacturer, same models and same electrochemical system
7. The conformal coating is applied to PCB boards was declared meet the requirements of IEC 60664-1 and IEC 60664-3 by manufacturer
8. T_{amb} : -20°C to +50°C.
9. USB port only to be used in Non-hazardous area.
10. PX connect with pressure measuring module CDPX-Ex only; the connected cables and flexible hose used for the external pressure modules are made of insulation materials, so end user should consider the risk of electrostatic discharge during material selection and installation process
11. Metallic parts (only fasteners) presented a maximum capacitance of total 110pF, end user should consider this risk for suitable application
12. No additional input energy limitation are required for Type-C USB port and DC charging port when U_m does not exceed 250V (internal OVP/OCP are designed in line with IEC 60079-11)
13. Do not remove the silicone rubber protective sleeve from the enclosure of equipment in Hazardous area
14. IS parameters must be strictly observed in full for different external measuring ports on the different models in accordance with Ex instruction

15. Intrinsically safe electrical system between IS apparatus and Associated apparatus or other IS apparatus:

Item	I.S Interface	External Measuring Instrument	System
Equipment group	IIC	IIC	IIC
Level of protection	ia	ia	ia
Temperature class	T4	T4	T4
Ambient temperature	-20°C~+50°C	-20°C~+50°C	
Voltage	U _o	U _i (30V)	
Current	I _o	I _i (100mA)	
Power	P _o	P _i (0.75W)	
Cable parameters			
Capacitance	C _o	C _i	C _c
Inductance	L _o	L _i	L _c
L/R ratio	/	/	/
Grounding	Isolated	Isolated	Isolated

$$U_o \leq U_i$$

$$I_o \leq I_i$$

$$P_o \leq P_i$$

$$C_o \geq C_i + C_c$$

$$L_o \geq L_i + L_c$$



Standard Compliance

- EN IEC 60079-0:2018
- EN 60079-11:2012
- IEC 60079-0:2017 Edition 7.0
- IEC 60079-11:2011 Edition 6.0

Ex information for equipment name

- National regulations: ATEX directive 2014/34/EU and IECEx scheme 02
- Certificate No.: TÜV 20 ATEX 8509 X and IECEx TUR 20.0009X
- Ex Marking for EU-Type Examination:  II 1 G Ex ia IIC T4 Ga
- Ex Marking for IECEx CoC: Ex ia IIC T4 Ga
- Tamb: -20°C~+50°C
- IP Rating: IP20
- I.S Parameters:

Additel273Ex

Handheld Pressure Calibrator

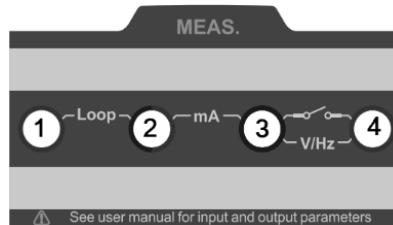

Input parameters, simple connection

Connection	Function	U _i /V	I _i /mA	P _i /mW	C _i /nF	L _i /mH
J1、 J3	HART (external power and external resistance)	30	100	750	10	0
J2、 J3	Current measurement	30	100	750	1	0
J4、 J3	Voltage, frequency and switch measurement	30	100	750	1	0
J1、 J2	Loop Circuit Transmitter Current Measuring / HART (Internal Power and Resistance)	30	100	750	10	0

Output parameters, simple connection

Connection	Function	U _o /V	I _o /mA	P _o /mW	C _o /μF	L _o /mH
J1、 J3	HART (external power and external resistance)	25.2	79.16	499	0.107	9
J2、 J3	Current measurement	5	0.85	1.1	87	100
J4、 J3	Voltage, frequency and switch measurement	5	0.85	1.1	87	100
J1、 J2	Loop Circuit Transmitter Current Measuring / HART (Internal Power and Resistance)	25.2	79.16	499	0.107	9

Intended use

- The equipment to be used in Zone 0 hazardous area with gas group IIC.
- The equipment is used in oil and gas platforms, oil refineries, chemical and petrochemical plants, pharmaceutical industry, energy and gas processing industries.



1. Introduction

1.1 Product Overview

Additel's 273Ex is an intrinsically safe handheld multifunctional pressure calibrator with a color touchscreen, smartphone like interface, built-in quick test tasks and optional HART communications capability. This innovative Additel product drastically improves explosion-proof field testing and calibration. The Additel 273Ex has a built-in atmospheric pressure sensor, so that absolute pressure and the gauge pressure are easily facilitated. With three pressure module inputs, one switchable at the bottom and two digital inputs on the side, the user can configure the setup accordingly and easily meet the needs of pressure calibration and testing in virtually any environment.

Contact Us

TEL: 1-714-998-6899

Or visit Additel website: www.additel.com

1.2 Technical specification

1.2.1 General specification

Table 1 General specification

General Specifications	
Input Channels	Top: 1 electrical signal measurement channel, ϕ 4mm banana jacks
	Right side: 2 channels for external digital pressure modules, 5-core dedicated aviation plug
	Bottom: embedded digital pressure module (model ADT158Ex), field switchable.
	Internal: 1 embedded atmospheric pressure sensor
Barometric Accuracy	± 55 Pa
Measurement Rate	mV, V, mA & frequency: 3 times/sec
	Pressure module: 1~10 times/sec selectable (3 as default)
	Barometer: 1 time/sec
Power	4000mAh, 14.4Wh explosion-proof intelligent lithium battery, charging time = 6~8 hours, battery can be charged independently Typical working time 100 hours (measurement mode)
Environmental	Guaranteed temperature range of technical specifications: (-10 ~ 50) $^{\circ}$ C *Temperature coefficient: ± 5 ppm FS/ $^{\circ}$ C (-20 to -10) $^{\circ}$ C
	Operating temperature: (-20 ~ 50) $^{\circ}$ C
	Storage temperature: (-30 ~ 70) $^{\circ}$ C
	Humidity: 0% to 95% RH, non-condensing



	Altitude: 3000 meters
Warm-up Time	10 min to fully meet technical specifications
Port Protection Voltage	30V max
Explosion-proof Grade	ATEX & IECEX: Ex ia IIC T4 Ga (Ta = -20°C to + 50°C)
	CSA: Class I, Division 1, Group A,B,C and D, T4 Class I, Zone 0, AEx ia IIC T4 Ga Ta = -20°C to + 50°C Ex ia IIC T4 Ga
	UKCA-EX
CE Certification	TUV IEC61326, IEC61010
Rohs Compliance	Rohs II Directive 2011/65/EU, EN50581:2012
Protection Level	IP67, 1 meter drop test
Communication	Isolate USB-Type C (slave), Bluetooth
Display	4.4-inch color display capacitive screen, transfective, with LED backlight
Size	6.97" x 4.13" x 2.04" (177 mm x 105 mm x 52 mm) which doesn't include bottom ADT158Ex.
Weight	1.98 lb (0.9 kg)
Warranty Time	1 year

1.2.2 Signal measure specification (environmental temp.: 20±10°C, 1 year accuracy)

Table 2 Signal measure specification

Specification	Range	Accuracy	Resolution	Note
Voltage Measurement	±300mV	0.015%RDG + 0.005%FS	1uV	Impedance: >100MΩ
	±30V	0.015%RDG + 0.005%FS	0.1mV	Impedance: >1MΩ
Current Measurement	±30mA	0.015%RDG + 0.005%FS	0.1uA	Impedance: <40Ω
Frequency Measurement	0.01~50000Hz (auto range)	0.005% RDG + 2 last digit	6-digit auto-resolution	Min threshold voltage: 2.5V
	Units: Hz, kHz, MHz, CPM, CPH, s, ms, us			
Switch On-Off Measurement	Inspection voltage: (3 ~ 30)V Response speed: < 10ms, supports wet and dry switch			
Pulse Count	0 ~ 9999999, optional rising edge and falling edge Min threshold voltage: 2.5V			
Loop Power	20V ± 10%, max output impedance: 320Ω, max load current: 25mA			

Note 1: When the environmental temperature is (-20~-10) °C, the temperature coefficient is:

(1) Measure of voltage, current : ±5ppmFS/°C.

Note 2: Input characteristics:

(1) Voltage range: -300~300mV input impedance >100 MΩ;

(2) Voltage range: -30~30V input impedance >1MΩ;

(3) Current measure: input impedance <40Ω;

Note 3: Minimum threshold voltage for frequency and pulse measure: 2.5V;

Note 4: The frequency measure supports following units: Hz, kHz, MHz, CPM, CPH,s, ms, μ s;

Note 5: There are rising edge and falling edge trigger mode available for pulse measure.

1.3 Basic Structure

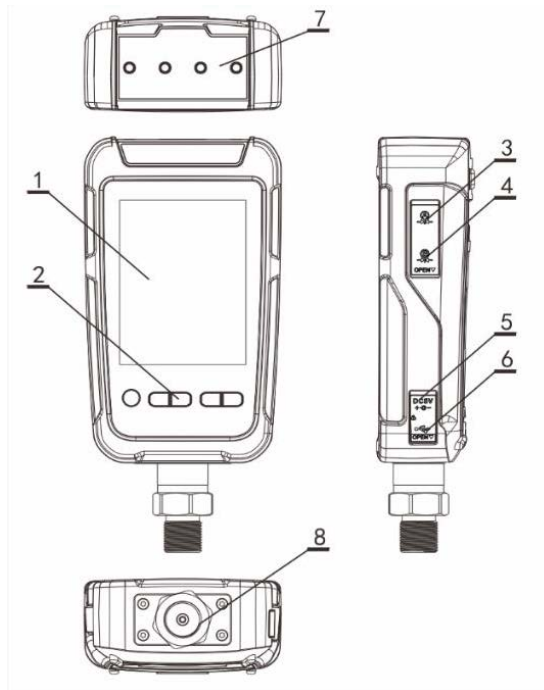

Figure 1 Basic Structure

Table 3 Basic Structure

Subject	Content	Description
1	Display+ capacitive touch screen	Display area, touchable
2	Keys	For operating the device
3	Lemo port A	Connect to external pressure module.
4	Lemo port B	Connect to external pressure module.
5	Adaptor port	Power supply from adaptor.
6	USB slave port	For USB communication.
7	Electric test plug	Connection for electric test, including cables and HART communication.
8	Pressure module	For pressure measure

1.4 Standard Package Contents

Table 4 Accessories

Accessories		
Standard	Test leads (2 red and 1 black)	1 set
	Ex-proof USB cable type A to C	1 pc
	Adaptor 5V	1 pc
	Ex-proof adaptor cable	1 pc
	Ex-proof intelligent Li-ion battery	1 pc



	Module removal tool	1pc
	ISO 17025 accredited calibration certificate	1 pc
Optional	ADT158Ex digital pressure module	
	ADT161Ex digital pressure module	
	9060 Pressure module connection cable	
	9906A Hard carrying case	
	ACal calibration software	
	Additel / LogII datalogging software	
	Additel / Land data downloading software	

Note: in case of changes to the accessories list, please refer to the packing list in shipping.

1.5 Power supply description

Power is supplied by 1 pc Ex-Proof Intelligent Li-ion battery.

- Ex-Proof Li-ion battery is chargeable by external power independently.
- The power adaptor is adaptable for standards in various countries.
- Do not expose the battery to fire or short circuit the battery.
- Use only the Additel power adaptor and designated battery models.



Figure 2 Adaptor and the power plug

2. Overview for display and basic functions











The ADT273Ex will automatically go to the Calibrator function after powered on. It can also be returned to main interface for access to all the functions (Figure 3).

2.1 Main interface

In the main interface, there are three sections from top to bottom: status bar, application list, and main function guide, as shown in Figure 3.

2.1.1 Status bar

On the top of the main interface shows the status information, including:

1. System time: real-time of the system
2. Battery: real-time display the battery level and charging status. Icon  indicates the adaptor is connected.
3. Bluetooth: icon  indicates Bluetooth function is on, icon  indicates off;
4. Module A: icon  indicates the external module A is connected, while  indicates not connected;
5. Module B: icon  indicates the external module B is connected, while  indicates not connected;
6. Message center: icon  flashes means there is messages, warnings or abnormal, icon  means no message;
7. 24V status: icon  indicates 24V power supply is on, no icon indicates the 24V power supply is off;
8. Screen lock: icon  means the screen is locked.

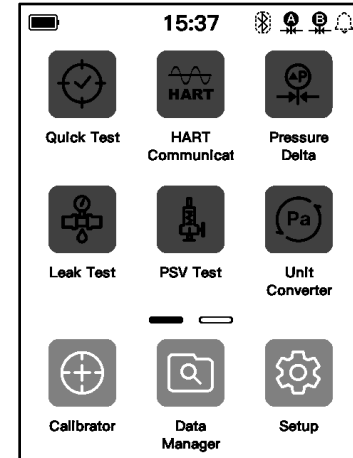



Figure 3 Main Interface

2.1.2 Apps list

The Apps list shows all the applications provided in the device, including Quick Test, HART, Differential Pressure Module, Leak Test, PSV Test, Units Converter and Wiring Help. Click the button , or use the left and right key to switch between interfaces of the APPs list.

2.1.3 Main function guide

The main function guide at the bottom of the interface provides access to three main functions of the device: calibrator, data manager and setup.

2.2 Control center

In any interface of the device, the control center (Figure 4 Control Center) can be called up by physical key . It provides detailed information of date, battery, diagnostic center, screenshot functions, and some shortcuts items.

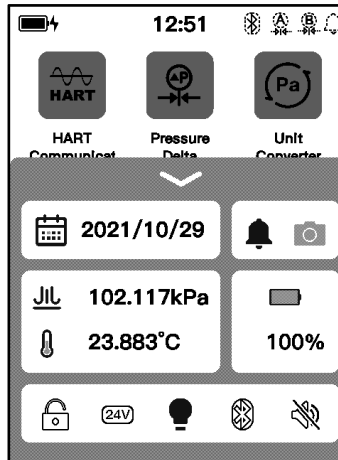



Figure 4 Control center

2.2.1 Date and battery

In the control center the current date and battery percentage are shown.





2.2.2 Diagnostic center and screenshot

Click icon  in the control center to open the diagnostic center, which shows the real-time diagnostic hardware status

of the device. If a device function fails, check the cause here, as shown in Figure 5. Click icon  in the diagnostic center to see the history log. Click  icon to take the snapshot, which can be viewed or deleted in the data management section.



2.2.3 Shortcut settings

The control center provides series of shortcut settings:

1. Click icon  to lock the screen, any touch operation and physical keys except the control center and power are invalid during lock.
2. Click icon  to open and close 24V loop power supply.
3. Click icon  to turn the backlight on or off.
4. Click icon  to turn Bluetooth on or off.
5. Click icon  to enable and disable system sound.

3. Calibrator

The ADT273Ex calibrator can be used to calibrate and measure pressure, as shown in Figure 5. Channel 1 at the top of the screen is mainly used for electrical signal measurement. It has several types of signals to be selected. Channel 2 at the bottom of the screen is mainly used for pressure measure functions, which has up to 4 pressure channels.

On the middle of the channel there is the current measured signal of this channel. The icon of the signal type and the corresponding range information is displayed on the upper left; click this icon to pop up a menu for switching the signal type. Click the icon  in the upper right corner to set the current channel in the pop-up menu. Click the icon  in the lower right corner to zero the current channel. If the signal type selected in the channel has multiple values for display (for example, after enabling scaling, it will show the scaled value and initial value simultaneously), the channel will also display these signal values below the main signal value.

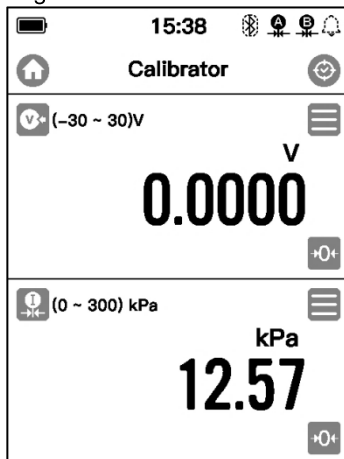

Figure 5 Calibrator main screen

3.1 Electrical Measurement

3.1.1 Voltage measurement

Please connect electrical leads correctly as shown in Figure 6, based on your application. Then switch the measurement signal of channel 1 to voltage measurement using the icon in the top left.

In order to ensure measurement accuracy and adapt to more usage scenarios, two different ranges can be selected

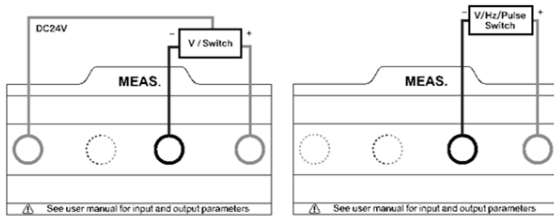

Figure 6 Voltage / Frequency / Pulse / Switch Measurement

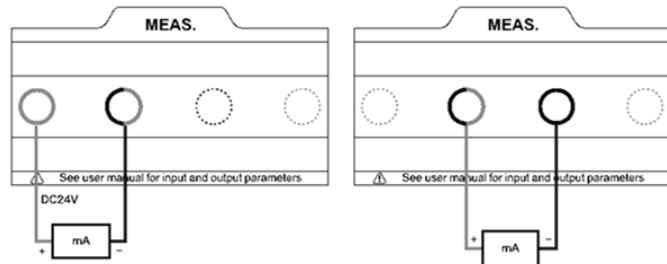



Figure 7 Current Measurement

for voltage measurement in this device: $(-30\sim30)V^{u*}$ and $(-300\sim300)mV^{mv*}$; users should select the appropriate measurement range according to the device application.



3.1.2 Current measurement

Please connect correctly as shown in Figure 7. Then switch the measurement signal of Channel 1 to current measurement $(-30\sim30)mA^{mA*}$.

3.1.3 Frequency measurement

The wiring of the frequency measurement function is the same as the voltage measurement. Please connect correctly as shown in Figure 6. Then switch the measurement signal of channel 1 to frequency measurement (0.01~50k)Hz .

3.1.4 Pulse measurement

The wiring method of the pulse measurement function is the same as the voltage measurement. Please connect correctly as shown in Figure 6. Then switch the measurement signal of channel 1 to pulse measurement (0 ~9999999) Pulse . Pulse measurement allows the user to set the pulse counting method. In the pulse measurement mode, enter the settings menu  to select whether the pulse counting uses rising or falling edges for counting.

3.1.5 Switch measurement

The wiring method of the switch measurement function is the same as the voltage measurement. Please connect correctly as shown in Figure 6. Then switch the measurement signal of channel 1 to switch measurement .

When channel 2 selects the appropriate measurement item, the calibrator can display the measured value of channel 2 when the switch action occurs. For example: channel 1 selects switch measurement, channel 2 selects external pressure module for pressure measure. At this time, when the switch channel detects the on-off state change, it will record the pressure value of channel 2 at this time. In this case, the device can be used to calibrate a typical pressure switch device. Click the switch icon in channel 1 or click the "on-off data" option in the channel menu on the right, user can view the last 8 switch action points and the action values measured by the corresponding channel 2 in the pop-up on-off data display page.

3.1.6 Filter

The calibrator provides two filtering methods: first-order linear filtering and moving average filtering to process data to meet the needs of different usage scenarios. Click the menu button  of the measurement channel, select the filter menu item in the pop-up menu, and the filter setting interface will be displayed (see Figure 8).

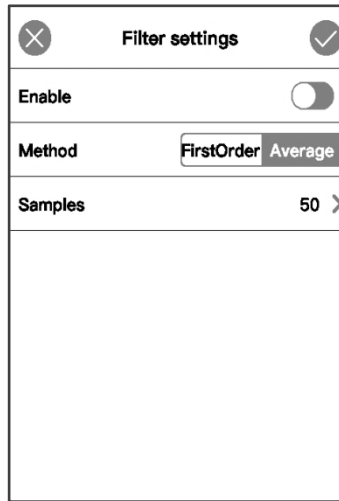

Figure 8 Filter settings

Table 5 Filter configurations

Subject	Valid Value	Description
Enable/disable	Enable/disable	Enable or disable the filter function
Method	first-order linear filter or moving average filter	Filtering method
Filter coefficient	0 ~ 1	Only available when the first-order linear filter is selected
Number of samples	1~50	Only available when the moving average filter is selected

3.1.7 Scaling

The scaling function gives the calibrator the ability to convert electrical measurement signals into other signals. Click the menu button  of the measurement channel, select the scaling menu item in the pop-up menu, and the parameter configurations related to scaling will be displayed (see Figure 9).

Table 6 Scaling Configurations

Subject	Valid Value	Description
Enable/disable	Enable/disable	Enable or disable the scaling function
Input range	Number	Range before scaling
Output range	Number	Range after scaling
Resolution	0~0.000001	The number of decimal places displayed after scaling
Transfer function	Linear, square or square root	Scaling transfer function

Scaling	
Enable	<input type="checkbox"/>
Initial Range	(-30 ~ 30) V >
Scaled Range	(0 ~ 100) kPa >
Resolution	0.0001 >
Transfer function	Linear >

Figure 9 Scaling configurations

3.2 HART Communications

Click the HART application icon on the main page, or switch the measurement channel to the HART measurement in the main interface of the calibrator to enter the HART communication function. HART communication provides the search, process variables selection, setting, diagnosis and testing of the transmitter functions. The correct connection method for using the HART communication function is shown in the Figures 10 and 11.

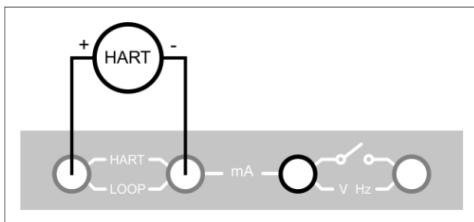

Figure 10 Internal power + internal resistance

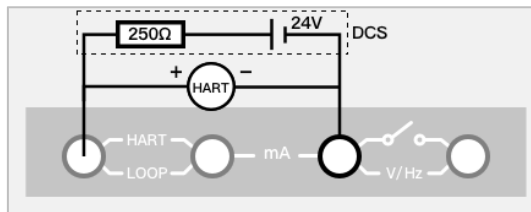



Figure 11 External power + external resistance

3.2.1 Search and connection

Click the manual search option in the calibrator HART measurement channel to enter the power supply mode selection page (if you select the HART application from the main page, the first entry is the power supply mode selection page), in this page you can select the internal power supply with internal resistor or external power supply with external resistor. After selecting the appropriate power supply mode, the system will use the selected power supply mode to search for the connected transmitter and list it. If need to search again, please click the icon  to restart the search.

After the search process, all the detected devices will be displayed in the interface list. Click the device in the list to be able to connect to the corresponding device. After the connection is completed, the transmitter device can be set up and diagnosed.

3.2.2 Setting

The setting items of the transmitter are divided into three categories, device information, sensor information and device output.

1. Device Information

Table 7 Transmitter device information

Subject	Valid Value	Description
Manufacturer	Read only	Transmitter manufacturer
Device type	Read only	Transmitter device type
Device ID	Read only	Transmitter model number
Label	Support letter and number input, the length cannot be greater than 8 characters	Transmitter custom label
Date	2000/1/1~2099/12/31	Date setting
Write-protect	Read only	Protection type
Message	Support letter and number input, the length cannot be greater than 20 characters	Custom information
Description	Support letter and number input, the length cannot be greater than 20 characters	Custom description
Final Assembly Number	Support number input, the length cannot be greater than 20 characters	The final assembly number of the transmitter
Preambles	5~20	The preamble number of the transmitter
Universal Version	Read only	Universal version of the transmitter
Software Version	Read only	Software version of the transmitter
Hardware Version	Read only	Hardware version of the



		transmitter
Device Version	Read only	Device version of the transmitter

2. Sensor information

Read the information on transmitter's unit, upper-lower limits, and the minimum span.

3. Device output

Table 8 Transmitter device output

Subject	Valid Value	Description
Process Variable/Range Units	°C, °F, °R, K	Measurement unit of the transmitter
Lower Limit of PV Range	Support numeric input, lower limit expanding 10%	Lower limit of the process variable
Upper limit of PV Range	Support numeric input, upper limit expanding 10%	Upper limit of the process variable
Transfer Function	Linear, Square Root	Transfer function of the transmitter
Alarm State	Read only	Alarm state of the transmitter
Damping	Support numeric input, ≥ 0	Damping time
Poll Address	0~15	Poll address of the transmitter
Burst Mode	Enable/ disable	Burst mode state
Burst Command	1,2,3	Burst command depends on different transmitters

3.2.3 Diagnosis and service

The diagnostic/service functions of the HART transmitter include current loop testing, primary variable zeroing, current adjustment, range migration, and sensor trim.

Note: Current loop test, current adjustment, and other diagnostic adjustment functions that involve the use of current loop

as a calibration target are available only when the polling address of the transmitter is 0. These functions cannot be completed in multi-point access mode (when the searching/polling address is 1~15). That is because the current output is fixed at around 4mA under this mode. If the user needs to adjust, they must set the polling address to 0 in the HART settings.

1. Current loop test

The current loop test allows users to compare and calibrate the current output signal of the transmitter and the current measurement signal of the device. During the test, the user can input the current measurement signal value of the device through the numeric keyboard or click the button of the specific current value at the bottom of the interface. After that, the device will send the applied current value to the transmitter, and display the output current value of the transmitter and the actual current measurement value of the device on the interface. Compare the two, if the value deviation is large, it means the transmitter needs to be calibrated /adjusted.

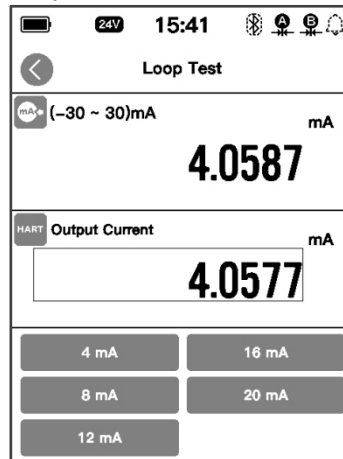

Figure 12 Current loop test

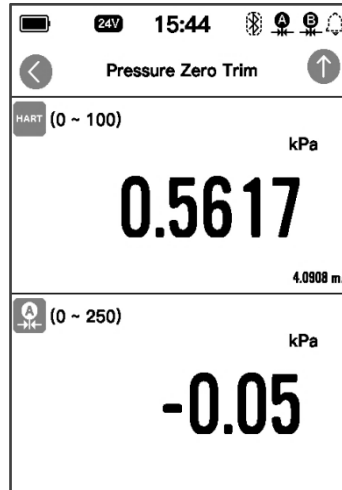



Figure 13 PVAO zero

2. Main Variable Zero

Set the zero point of the pressure transmitter to correct the zero offset of the transmitter. Under the zeroing mode, please select the pressure module connected to the device as the standard module. Then the upper channel in the interface displays the pressure value output by the transmitter, and the lower channel displays the pressure value measured by the selected standard module of the machine.

Click the apply button  on the upper right, the device will send a command to calibrate the transmitter.

3. D/A Adjustment

By adjusting the current output of the HART transmitter, the zero point (4mA) and full scale (20mA) output values of the transmitter PVAO are consistent with the actual output loop current value.

Take D/A zero calibration as an example. After entering this calibration mode, the upper channel of the interface displays the current signal value actually measured by the calibrator (ADT226/227), the lower channel displays the current value of PVAO zero point, which is fixed at 4 mA. When calibrating, user can manually enter the measured current value in the adjustment value input box at the bottom, or can click the "Fetch" button to automatically obtain the actual measured current signal value of the calibrator. After the adjustment value is set, click the application button  on the upper right, and the calibrator send the adjusted value to the transmitter.

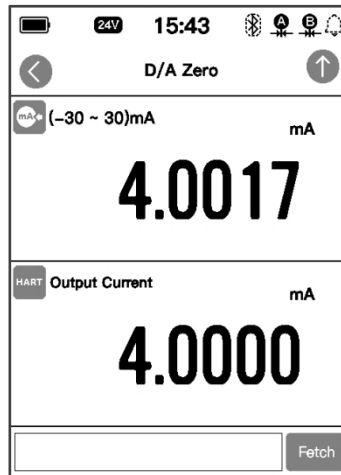

Figure 14 D/A adjustment

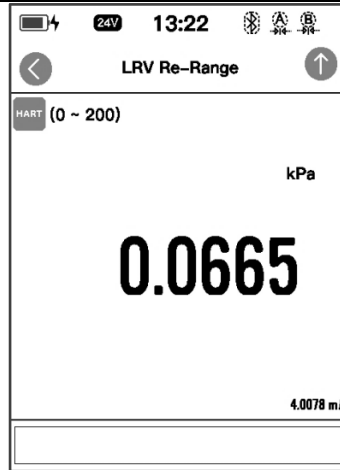

Figure 15 Range migration

4. Range migration

The transmitter range migration function allows users to flexibly map the original range of the transmitter.

5. Sensor trim

The calibrator provides sensor trim function for HART transmitters, which is generally divided into low-end adjustment and high-end adjustment. The user can select the appropriate pressure module (built-in module, external module A, external module B) as the pressure standard to adjust the transmitter.

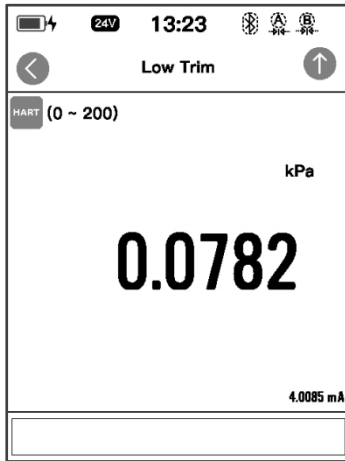

Figure 16 Sensor trim Figure

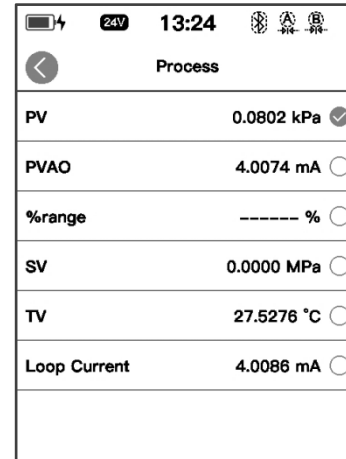

Figure 17 Process variable selection





3.2.4 Process variable setting

The HART transmitter has a variety of process variables to choose from, and the calibrator provides the function of viewing and selecting the process variables of the transmitter.

Table 9 HART process variable

Subject	Description
Process Variable	The unit of the master variable depends on the setting of the transmitter. Please refer to transmitter's output setting for details
Output current	Transmitter output current, unit: mA
Percentage	The percentage of readout in the range of the transmitter
Loop Current	Loop current of the transmitter, unit: mA
Second variable	The second variable of the transmitter, depends on the settings of the transmitter manufacturer
Third variable	The third variable of the transmitter, depends on the settings of the transmitter manufacturer
Forth variable	The forth variable of the transmitter, depends on the settings of the transmitter manufacturer

3.3 Pressure measurement

There is built-in pressure module on the bottom of the calibrator, and the default module for measuring is . And the external pressure modules A  and B  are available for selection once connected. To enable the differential pressure measurement in the Pressure Delta application (refer to Section 7.4), once the required condition is met, it can be switched to differential pressure measure . Click the pressure unit above the measured value to switch the units in the pop-up window.

Click the menu button  in the pressure measurement channel and click the "Settings" menu in the pop-up menu to set the pressure type, resolution, stability, tare and other functions of the current pressure measurement channel.

Table 10 Pressure measurement settings

Subject	Valid Value	Description
Resolution	4/5/6	Resolution of current measurement channel
Pressure type	GP/ AP	Current measurement channel pressure type
Measurement frequency	1~10Hz	Data acquisition frequency of the current measurement channel
Stability enable	Enable/disable	Whether to turn on the stability judgment function
Stability value	Pressure value or percentage of range	A value for judging whether the pressure is stable. If the measured value fluctuates less than this value within the stable time, the calibrator will judge as stable
Stabilization time	Number	Time to judge the pressure stability
Tare enable	Enable/disable	Enable or disable tare function
Tare value	Pressure value	Correction value of the tare function

3.3.1 Filter

Refer to the section 3.1.6.

3.3.2 Module information

The basic module information, including the serial number, range, pressure type and firmware information.

4. System settings

On the main page of the device, click the system setting button  in the middle of the bottom to enter the system setting interface. System maintenance, system calibration, and various basic system settings are provided in the system settings.

4.1 Bluetooth communication

The calibrator has the function of Bluetooth communication. Click the "Bluetooth Communication" menu item in the system setting interface to enter the Bluetooth communication setting interface. The Bluetooth communication setting interface provides the enabling and disabling of the Bluetooth communication function and the query function of the Bluetooth device name and physical address.

4.2 Power management

Click the "Power Management" menu item in the system setting interface to enter the power management interface. In the power management interface, the user can enable and disable the screen backlight, set the time for automatically turning off the backlight, automatic standby, and automatic shutdown.

4.3 System calibration

Click the "System Calibration" menu item in the system setting interface, and enter the calibration password "123456" in the pop-up password input box to enter the system calibration interface. In the system calibration interface, you can calibrate all the measurement and output signal in the device. The calibration process is as follows:

1. Select the item to be calibrated in the signal list.
2. Use a high-precision standard device, after fully warming up, follow the calibration guide in the interface and click the "Start" button to start the calibration.
3. According to the reference calibration point provided on the interface, select the appropriate standard value and enter it.
4. Click the "Finish" button to send the calibration data to the module to complete the calibration. Click the "Restore" button at the bottom of the calibration interface to restore the field calibration data of the device. Click the "Cancel zero" button below to clear data of the current signal.

4.4 Services

4.4.1 Maintenance

This function is only open for manufacturer.

4.4.2 Restore to factory data

Enter the password for this function, default password is 123456.

- Restore to the factory data will not restore the system calibration data.

4.4.3 Running information

Running information includes the barometric reading, current battery voltage and electric module information.

4.4.4 System upgrade

Users can upgrade the device firmware via the USB-C.

4.5 Personalization

Click the "Personalization" menu item in the system setting interface to enter the personalized setting interface. In the personalized setting interface, users can set the device's sound, language type, current time and date, and time and date format according to their own preferences.

4.5.1 Sound

Change the sound level by adjusting the volume bar. It also provides sound configuration, as in Table 11.

Table 11 Sound settings

Subject	Valid Value	Comment
Sound enable	On / Off	Sound enable setting
Prompt sound	On / Off	Prompt sound setting
Touch sound	On / Off	Touch sound setting
Over range sound	On / Off	Over range sound setting
Alarm sound	On / Off	Alarm sound setting



4.5.2 Language

The device provides a multi-language user interface. Use this menu to change between the provided languages.

- After the language is selected, the device needs to be restarted for the changes to take effect.

4.5.3 Date & Time

The device provides customizable settings for time and date, as shown in Table 21.

Table 12 Date & time

Subject	Valid Value	Comment
Date	2000-1-1 ~ 2099-12-31	Date setting
Time	00:00 ~ 23:59	Time setting
Date format	Y-M-D / M-D-Y / D-M-Y	Date format setting
Separator	-, /, .	Date separator setting
24 hours	enable	24-hour or 12-hour format

4.6 Product information

Product information is read-only information, including basic information and the module information.



- Basic information: including model, serial number, and system version information.
- Module information: including EM board version, ES board version and TMS board version.
- External module information: including external modules A and external module B.

5. Data management







On the main page of the device, click the file management button  in the middle of the bottom to enter the file management interface. The file management interface is classified and managed by functional modules, and the data saved by each function is managed in the corresponding folder for convenience.

The functional modules that can save data files are: snapshot, PSV test and leak test. In the corresponding folder, the users can open the operation menu through the menu button  in the upper right corner, and delete or batch delete the files in it.

6. Quick test

The calibrator provides a convenient quick test function, which is used for calibrating variety of pressure devices. At the same time, the calibration data can be automatically collected, stored, analyzed and viewed. Click the task icon  on the main interface of the device or click the task icon  at the top right in the calibrator interface to enter the test interface.

The quick test provides task types for three types of pressure devices: pressure gauge, pressure transmitter and pressure switch. The procedures are as follows:

- (1) Create the task: Click corresponding items in the interface according to DUT (Device Under Tested) type.
- (2) Complete the necessary information of the test in the “Create the Task” interface (for example: DUT range, accuracy, etc.), then click icon  to start.
- (3) Click icon  to record the DUT readout and the measured value of the calibrator. For the pressure gauge, the user needs to manually input the current readout. Click icon  to delete last entered data.
- (4) After the task is finished, click the save button  and complete the information required for saving the task data in the pop-up task saving interface. Click OK button to save the task data.
- (5) For tasks that have been performed and saved, the task results will be showed in the task list on the history data list. Click icon  in the quick test interface to review the history data. The icon  in the task list indicates that test failed;

the icon  indicates that the DUT has passed the test and meets the accuracy of the task. Click any of the tasks in the list to view and edit the task details and data.



6.1 Dial pressure gauge and digital pressure gauge calibration

1. Connect to DUT
 - Connect the internal pressure module. If using an external pressure module, connect them to LEMO port A or B.
2. Create the task

Create the corresponding DUT tasks as described above, and fulfill the necessary information.

Table 13 Pressure gauge task setting

Subject	Valid value	Description
Pressure type	Gauge / absolute / differential	Pressure type of DUT
Input range	Numbers	Input range of DUT
Accuracy	0.06%, 0.1%, 0.16%, 0.25%, 0.4%, 0.6%, 1%, 1.6%, 2.5%, 4%, custom	Accuracy of DUT. If choose custom, the input number means the accuracy level of the dial pressure gauge. For example: input 1.5 for gauge level of 1.5, the range is (0.001~100)

3. Start the task
 - Select several points within the DUT's range.
 - Use the pressure source to control the DUT's readout reach the set points, then manually input the readout.
 - Click icon  to record the DUT's readout and the measured value of the calibrator.
 - Click icon  to delete the last data.

4. Finish the task

After the task is finished, click the save button  to go to the Saving interface, fulfill the information required and save the task data of the result.

Table 14 Save task data setting

Subject	Valid value	Description
Name	Numbers, letters, symbols	Task name
Operator	Numbers, letters, symbols	Information for operator
Date and time	Valid date and time	Date and time of the task performing
Note	Numbers, letters, symbols	Additional information

6.2 Pressure transmitter (voltage, current and HART)

1. Connect to DUT

- Connect the internal pressure module. If using an external pressure module, connect them to LEMO port A or B.
- Connect the DUT output with the calibrator according to the signal type, current (Figure 7), voltage (Figure 6), or HART (Figures 10 and 11).

2. Create the task

Create the corresponding DUT tasks as described above, and enter the necessary information.

Table 15 Pressure transmitter task setting

Subject	Valid value	Description
Pressure type	Gauge / absolute / differential	Pressure type of DUT
Input range	Numbers	Input range of DUT



Output range	Numbers	Output range of DUT
Transfer function	Linear / square root	Transfer function of the DUT
Accuracy	0.06%, 0.1%, 0.16%, 0.25%, 0.4%, 0.6%, 1%, 1.6%, 2.5%, 4%, custom	Accuracy of DUT. If choose custom, the input number means the accuracy level of the DUT. For example: input 1.5 for level of 1.5, the range is (0.001~100)
Process variable	Process variable/ output current/ percentage/ loop current	Process variable of HART transmitter(only available for HART transmitter)

3. Start the task

- Please refer to the “Start the Task” in Section 6.1.
- The calibrator will automatically use the measured value of the voltage measurement, current measurement or the HART measurement according to the DUT output type set by the user, without manual input.

4.Finish the task

Refer to “Finish the Task” in Section 6.1.

6.3 Pressure switch

1. Connect to DUT

- Connect the internal pressure module. If use external pressure module, connect them to LEMO port A or B.
- As shown in the Figure 6, connect the DUT output with calibrator’s electric module.

2. Create the task

Create the corresponding DUT tasks as described above, and enter the necessary information.

Table 16 Pressure switch task setting

Subject	Valid value	Description
Pressure type	Gauge/ absolute/ differential	Pressure type of DUT
Input range	Numbers	Input range of DUT
Set action type	Opened / closed	Action type of the DUT
Set point	Value	Action set point of the DUT
Accuracy	0.06%, 0.1%, 0.16%, 0.25%, 0.4%, 0.6%, 1%, 1.6%, 2.5%, 4%, custom	Accuracy of DUT. If choose custom, the input number means the accuracy level of the DUT. For example: input 1.5 for level of 1.5, the range is (0.001~100)

3. Start the task

- Please refer to the Start the task in Section 6.1.
- When the pressure switch moves (open/close) during the task, the calibrator will automatically record the pressure value at the moment of the action, without manually input.

4. Finish the task

Refer to “Finish the Task” in Section 6.1.

7. Applications

7.1 Units converter

The calibrator provides a unit converter for pressure units and temperature units. Users can select multiple pressure units or temperature units for conversion. Click the unit converter icon on the main interface of the device to enter the unit converter. Click  icon on the right top to select and switch between different types of units. Click the unit under the value display to select and switch between different units.

7.2 Leak test

The calibrator provides a pressure leak test function, which can perform self-checking on the seal of the calibrator. Click on the pressure module column to set the test parameters, see the table below:

Table 17 Leak test setting

Subject	Valid value	Description
Pressure type	GP/ AP	The pressure type being recorded, view detail according to calibrator's module
Pressure unit	Pressure unit	Select corresponding pressure unit
Waiting time	Numbers	The pressurizing time of external module
Test time	Numbers	Total record time
Unit of the rate	Second/ minute	Displayed unit after calculation

7.2.1 Leak Test Performing

1. Connect to air circuit
 - a. Connect the device to the gas circuit;
 - b. Click the start icon at the bottom of the screen, apply pressure to the leak test point;
 - c. Start counting down the waiting time, and record the real-time pressure at the end of the waiting time as the initial pressure;
 - d. Start the test, count down the test time, and start to calculate the real-time leakage, real-time leakage = initial

- pressure - real time pressure;
- e. Record the pressure at the end of the test time as the end pressure;
 - f. The entire leak detection process ends, and the final leakage = initial pressure - end pressure;
2. The whole process will be displayed in stages in the leak curve at the bottom of the screen.

7.3 PSV test

The calibrator provides function of PSV test, to test the safety pressure of the safety valves. Click the pressure module on the top, to set relevant parameters, see table below:

Table 18 PSV test setting

Subject	Valid value	Description
Pressure module	Internal pressure module, external module A or B	Select the pressure module
Test time	00:00:00 ~ 00:10:00	Set test time
Pressure unit	Different modules support different pressure units	Select corresponding pressure unit

7.3.1 PSV test performing

1. Connect air circuit
 - a. Connect the device to the air circuit;
 - b. Press the Start icon on the right of the screen to start performing, apply the pressure gradually to the safety valve;
 - c. Count down the test time and record the real-time pressure value and create the pressure curve, then record the maximum pressure during the process;
 - d. Count down complete, the entire leak test process finishes, save the data;
2. The whole process will be shown in the leak test curve at the bottom of the screen

7.4 Pressure delta

The calibrator provides the function of Pressure delta, which consists of two external modules (A and B). This provides a convenient differential pressure (DP) test solution in a high static pressure environment. The set parameters of the DP module are shown in the table below.



Table 19 Pressure delta setting

Project	Effective value	Description
Enable	Enable / disable	Enable or disable the differential pressure module. When the differential pressure module is enabled, the differential pressure module channels will be displayed in the related functions channel list.
Resolution	4/5/6	The resolution of differential pressure
Range	Numbers	Differential module measuring range
Calculate type	A-B or B-A	For the composite mode of differential pressure module, A and B represent external pressure module A and external pressure module B respectively
Real time data	----- or Real time differential pressure value	The real-time differential pressure value is displayed only when the differential pressure module is enabled and both external pressure modules A and B are online. Otherwise, the real-time differential pressure value is displayed as -----
Zero offset	zero offset when zeroing	Zero offset when differential pressure module zeroing
External module A	Module real time pressure values and units	Click to enter to view the module information
External module B	Module real time pressure values and units	Click to enter to view the module information

The following functions are also supported in the DP module management.

Zero: when enabling the DP module and both external A and B are online, users can perform the zero, the zero offset will be saved and used for calculating the differential pressure.

Cancel zero: cancel the zero offset when performing the zero operation, set the zero offset to 0.

7.5 Wiring help

The wiring help function in the calibrator can help users to connect the wires correctly under various working conditions of the calibrator. It can be entered by clicking the "Wiring help " menu in each channel, or by clicking the "wiring help" icon in the main interface of the device.



Additel Corporation

2900 Saturn Street #B

Brea, CA 92821 USA

Phone: 714-998-6899

Email: service@additel.com

website: www.additel.com