

Oxi 7310 Oxi 7310P

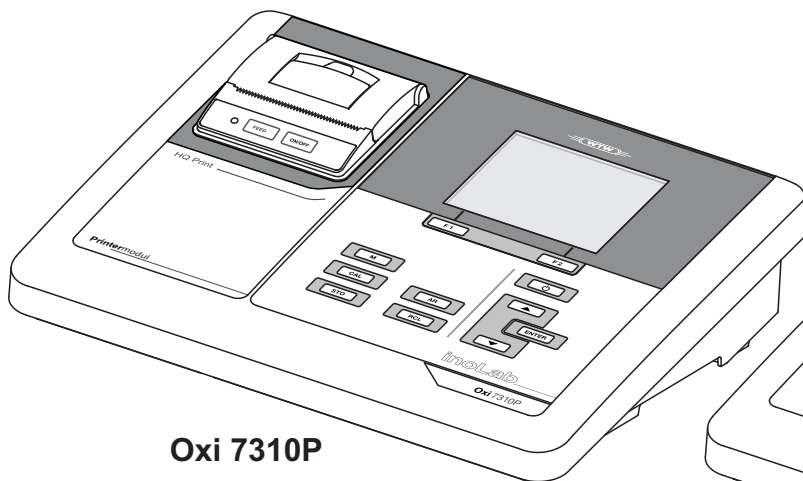

Oxi 7310P

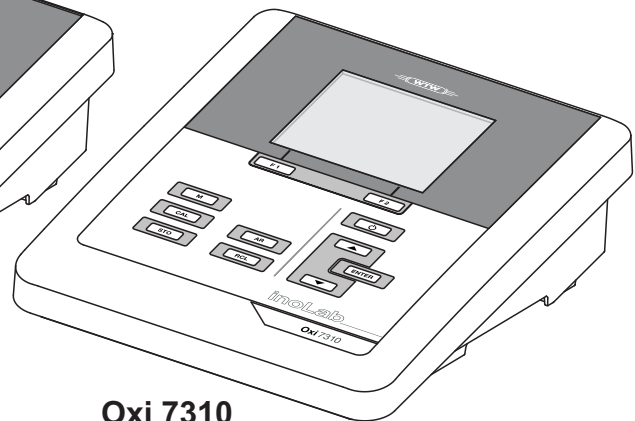

Oxi 7310

D.O. meter

Copyright

© Weilheim 2011, WTW GmbH

Reproduction in whole - or even in part - is prohibited without the express written permission of WTW GmbH, Weilheim.

Printed in Germany.

Oxi 7310 - Contents

1	Overview	6
1.1	Oxi 7310 meter	6
1.2	Oxi 7310P meter	7
1.3	Sensors	7
2	Safety	8
2.1	Safety information	8
2.1.1	Safety information in the operating manual	8
2.1.2	Safety signs on the meter	8
2.1.3	Further documents providing safety information	8
2.2	Safe operation	9
2.2.1	Authorized use	9
2.2.2	Requirements for safe operation	9
2.2.3	Unauthorized use	9
3	Commissioning	10
3.1	Scope of delivery	10
3.2	Power supply	10
3.3	Initial commissioning	10
3.3.1	Inserting the batteries	11
3.3.2	Connecting the power pack	12
3.3.3	Mounting the stand	12
4	Operation	13
4.1	General operating principles	13
4.1.1	Keypad	13
4.1.2	Display	14
4.1.3	Status information (meter)	14
4.1.4	Socket field	15
4.2	Switching on the meter	15
4.3	Switching off	16
4.4	Navigation	16
4.4.1	Operating modes	16
4.4.2	Measured value display	17
4.4.3	Menus and dialogs	17
4.4.4	Elements in menus and dialogs	17
4.4.5	Example 1 on navigation: Setting the language	19
4.4.6	Example 2 on navigation: Setting the date and time	20

5	Dissolved oxygen	22
5.1	Measuring	22
5.1.1	Measuring D.O.	22
5.1.2	Measuring the temperature	24
5.2	Calibration	25
5.2.1	Why calibrate?	25
5.2.2	When to calibrate?	25
5.2.3	Calibration procedures	25
5.2.4	Calibration in water vapor-saturated air (air calibration vessel)	25
5.2.5	Calibrating with a Comparison meas. (OxiComp)	26
5.2.6	Calibration data	28
6	Settings	30
6.1	Measurement settings	30
6.1.1	Changing the settings for D.O. sensors	30
6.1.2	Calibration interval	31
6.2	Sensor-independent settings	32
6.2.1	<i>System</i>	32
6.2.2	<i>Data storage</i>	33
6.3	Reset	33
6.3.1	Resetting the measurement settings	33
6.3.2	Resetting the system settings	34
7	Data storage	35
7.1	Manual storage	35
7.2	Automatic storage at intervals	36
7.3	Measurement data storage	38
7.3.1	Displaying and editing the measurement data storage	38
7.3.2	Erasing the measurement data storage	40
7.3.3	Measurement dataset	40
7.3.4	Storage locations	40
8	Transmitting data (USB interface)	41
8.1	Options for data transmission	41
8.2	Connecting a PC	42
8.3	MultiLab Importer	42
9	Printer (only Oxi 7310P)	43
9.1	Commissioning / switching the printer on or off	43
9.2	Operation / printing	44
9.3	Printer settings	44
9.4	Maintenance	44
9.4.1	Changing the roll of paper	44
9.5	What to do if... / printer	45
10	Maintenance, cleaning, disposal	46
10.1	Maintenance	46
10.1.1	General maintenance activities	46

10.1.2	Replacing the batteries	46
10.2	Cleaning	47
10.3	Packing	47
10.4	Disposal	47
11	What to do if...	48
11.1	Dissolved oxygen	48
11.2	General information	48
12	Technical data.	50
12.1	Measuring ranges, resolution, accuracy	50
12.2	General data	50
13	Firmware update.	53
14	Glossary	54
15	Index	57

1 Overview

1.1 Oxi 7310 meter

The Oxi 7310 compact precision dissolved oxygen (D.O.) meter enables you to perform D.O. measurements quickly and reliably.

The Oxi 7310 provides the maximum degree of operating comfort, reliability and measuring certainty for all applications.

The USB interface can be used for data transmission to a PC and for software updates of the meter.

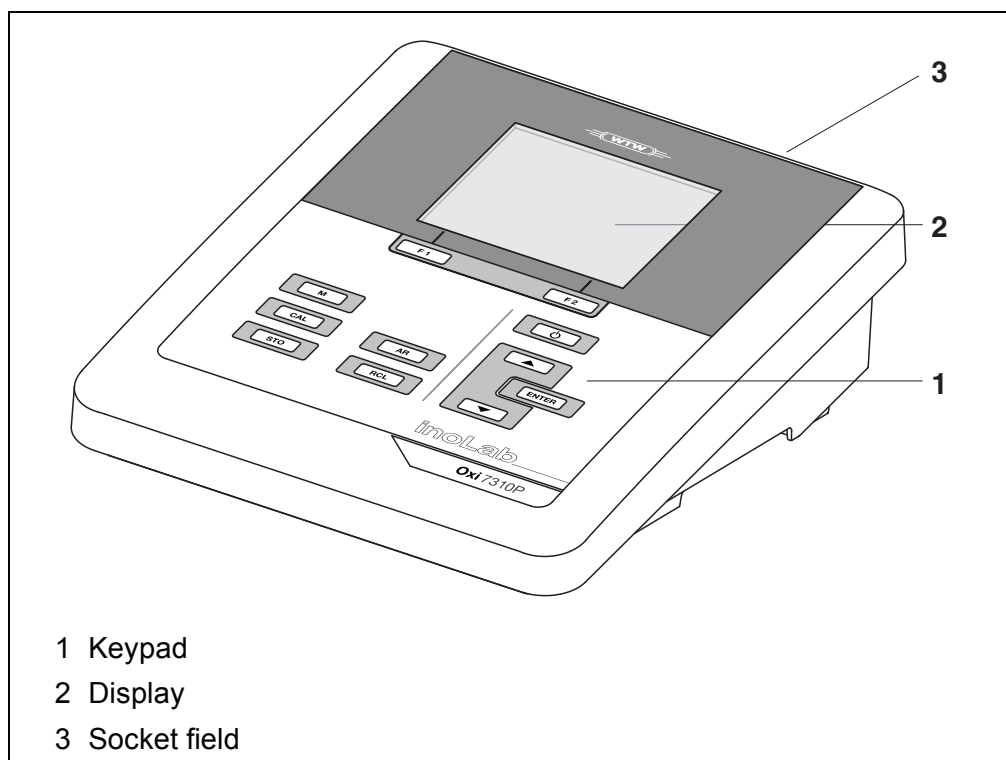

1.2 Oxi 7310P meter

The integrated printer of the Oxi 7310P enables to document measurements according to GLP requirements.



The information concerning the printer of the Oxi 7310P is given in a separate chapter (see section 9 PRINTER (ONLY OXI 7310P), page 43).

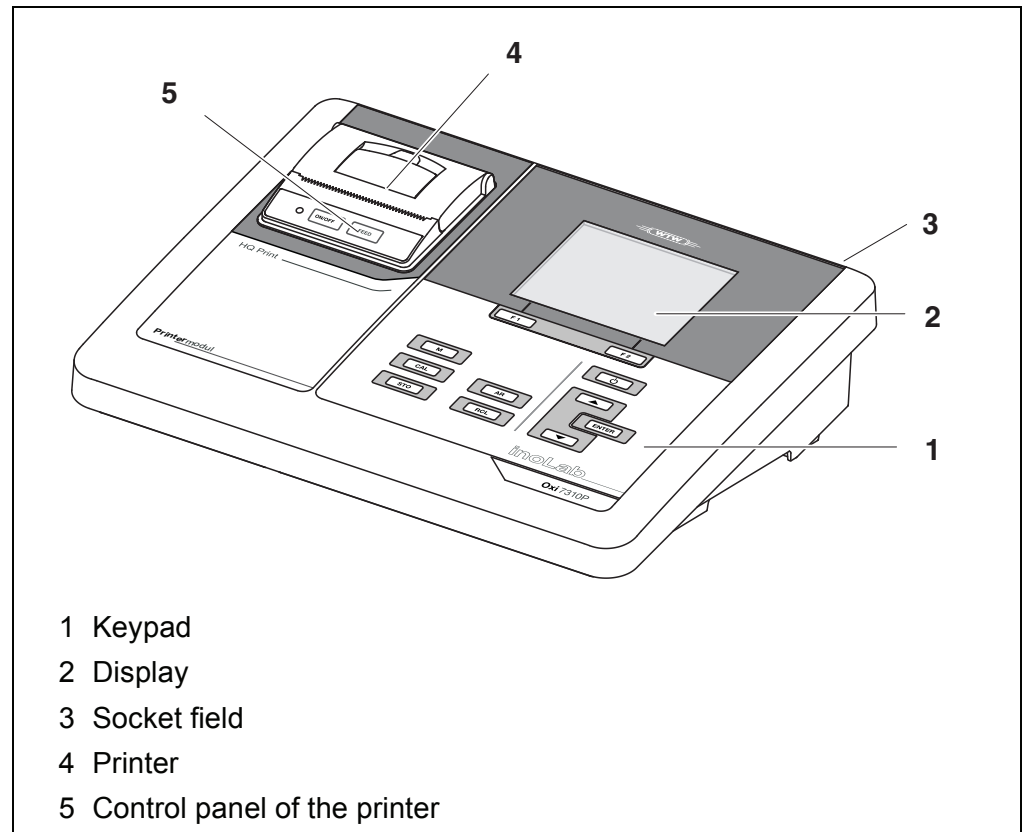

- 1 Keypad
- 2 Display
- 3 Socket field
- 4 Printer
- 5 Control panel of the printer

1.3 Sensors

A measuring system ready to measure consists of the Oxi 7310 meter and a suitable sensor.

Suitable sensors are D.O. (dissolved oxygen) sensors.



Information on available sensors is given on the Internet and in the WTW catalog, "Laboratory and field instrumentation".

2 Safety

2.1 Safety information

2.1.1 Safety information in the operating manual

This operating manual provides important information on the safe operation of the meter. Read this operating manual thoroughly and make yourself familiar with the meter before putting it into operation or working with it. The operating manual must be kept in the vicinity of the meter so you can always find the information you need.

Important safety instructions are highlighted in this operating manual. They are indicated by the warning symbol (triangle) in the left column. The signal word (e.g. "CAUTION") indicates the level of danger:

**WARNING**

indicates a possibly dangerous situation that can lead to serious (irreversible) injury or death if the safety instruction is not followed.

**CAUTION**

indicates a possibly dangerous situation that can lead to slight (reversible) injury if the safety instruction is not followed.

NOTE

indicates a possibly dangerous situation where goods might be damaged if the actions mentioned are not taken.

2.1.2 Safety signs on the meter

Note all labels, information signs and safety symbols on the meter and in the battery compartment. A warning symbol (triangle) without text refers to safety information in this operating manual.

2.1.3 Further documents providing safety information

The following documents provide additional information, which you should observe for your safety when working with the measuring system:

- Operating manuals of sensors and other accessories
- Safety datasheets of calibration or maintenance accessories (such as buffer solutions, electrolyte solutions, etc.)

2.2 Safe operation

2.2.1 Authorized use

This meter is authorized exclusively for D.O. measurements in the laboratory.

Only the operation and running of the meter according to the instructions and technical specifications given in this operating manual is authorized (see section 12 TECHNICAL DATA, page 50).

Any other use is considered unauthorized.

2.2.2 Requirements for safe operation

Note the following points for safe operation:

- The meter may only be operated according to the authorized use specified above.
- The meter may only be supplied with power by the energy sources mentioned in this operating manual.
- The meter may only be operated under the environmental conditions mentioned in this operating manual.
- The meter may only be opened if this is explicitly described in this operating manual (example: Inserting the batteries).

2.2.3 Unauthorized use

The meter must not be put into operation if:

- it is visibly damaged (e.g. after being transported)
- it was stored under adverse conditions for a lengthy period of time (storing conditions, see section 12 TECHNICAL DATA, page 50).

3 Commissioning

3.1 Scope of delivery

- D.O. meter Oxi 7310
- 4 batteries 1.5 V Mignon type AA
- Power pack
- USB cable
- Stand
- Stand holder
- Comprehensive operating manual
- Short instructions
- CD-ROM with
 - USB drivers
 - comprehensive operating manual
 - software MultiLab Importer

3.2 Power supply

The Oxi 7310 is supplied with power in the following ways:

- Mains operation with the supplied power pack.
- Battery operation (4 x alkaline manganese batteries, type AA)
- USB operation via a connected USB-B cable.

3.3 Initial commissioning

Perform the following activities:

- Insert the supplied batteries
- For mains operation: Connect the power pack
- If necessary, mount the stand
- Switch on the meter (see section 4.2 SWITCHING ON THE METER, page 15)
- Set the date and time (see section 4.4.6 EXAMPLE 2 ON NAVIGATION: SETTING THE DATE AND TIME, page 20)

3.3.1 Inserting the batteries



You can operate the meter either with normal batteries or with rechargeable batteries (Ni-MH). In order to charge the batteries, an external charging device is required.

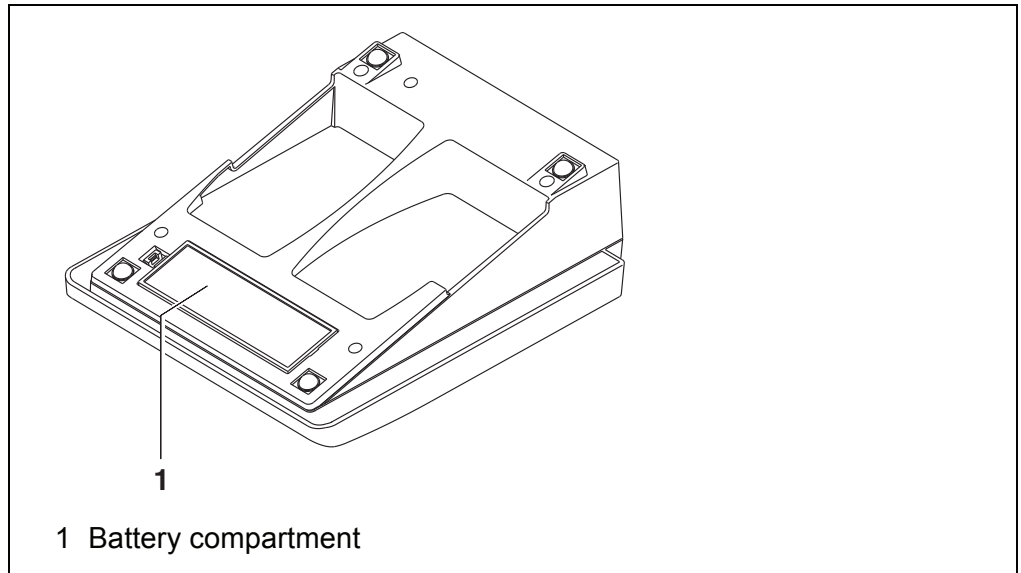

1. Open the battery compartment (1) on the underside of the meter.



CAUTION

Make sure that the poles of the batteries are positioned correctly.
The \pm signs on the batteries must correspond to the \pm signs in the battery compartment.

2. Place four batteries (type Mignon AA) in the battery compartment.
3. Close the battery compartment (1).
4. Set the date and time (see section 4.4.6 EXAMPLE 2 ON NAVIGATION: SETTING THE DATE AND TIME, page 20)

3.3.2 Connecting the power pack

**CAUTION**

The line voltage at the operating site must lie within the input voltage range of the original power pack (see section 12 TECHNICAL DATA, page 50).

**CAUTION**

Use original power packs only (see section 12 TECHNICAL DATA, page 50).

1. Connect the plug of the power pack to the socket for the power pack on the Oxi 7310.
2. Connect the original power pack to an easily accessible power outlet.

3.3.3 Mounting the stand

The stand base can be mounted at the right side of the meter.

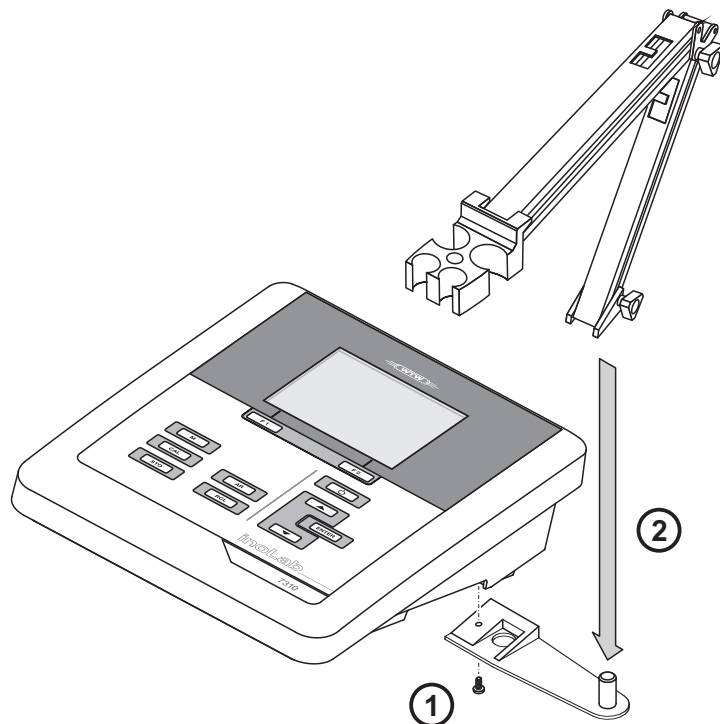









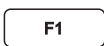
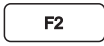

4 Operation

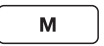
4.1 General operating principles

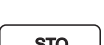
4.1.1 Keypad

In this operating manual, keys are indicated by brackets <.> .

The key symbol (e.g. <ENTER>) generally indicates a short keystroke (under 2 sec) in this operating manual. A long keystroke (approx. 2 sec) is indicated by the underscore behind the key symbol (e.g. <ENTER_>).

	<F1>: <F1_>: <F2>: <F2_>:	Softkeys providing situation dependent functions, e.g.: <F1>/[Menu]: Opens the menu for measurement settings <F1_>/[Menu]: Opens the menu for system settings
		
	<On/Off>:	Switches the meter on or off
	<M>:	Selects the measured parameter / Quits the settings
	<CAL>: <CAL_>:	Calls up the calibration procedure Displays the calibration data
	<STO>: <STO_>:	Saves a measured value manually Opens the menu for the automatic save function
	<RCL>: <RCL_>:	Displays the manually stored measured values Displays the automatically stored measured values
	<▲><▼>: <▲_><▼_>:	Menu control, navigation Increments, decrements values Increments, decrements values continuously
		
	<ENTER>: <ENTER_>:	Opens the menu for measurement settings / confirms entries Opens the menu for system settings
	<AR>	Freezes the measured value (HOLD function) Switches the AutoRead measurement on or off

4.1.2 Display

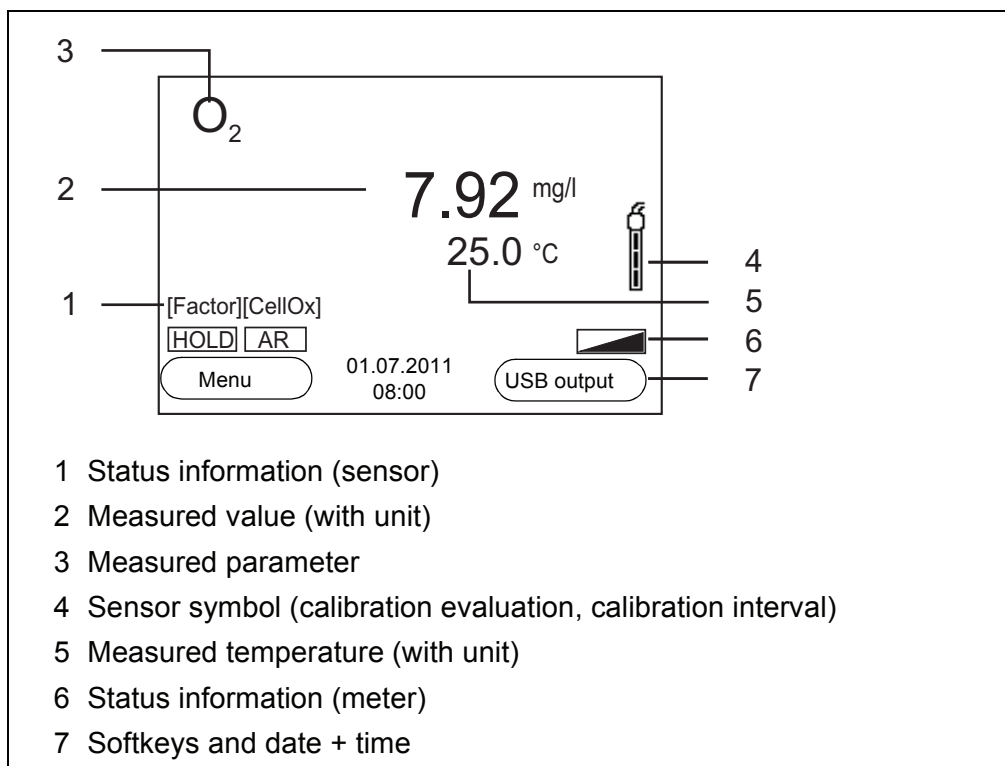

4.1.3 Status information (meter)

AR	Stability control (AutoRead) is active
HOLD	Measured value is frozen (<AR> key)
	Batteries almost empty

4.1.4 Socket field

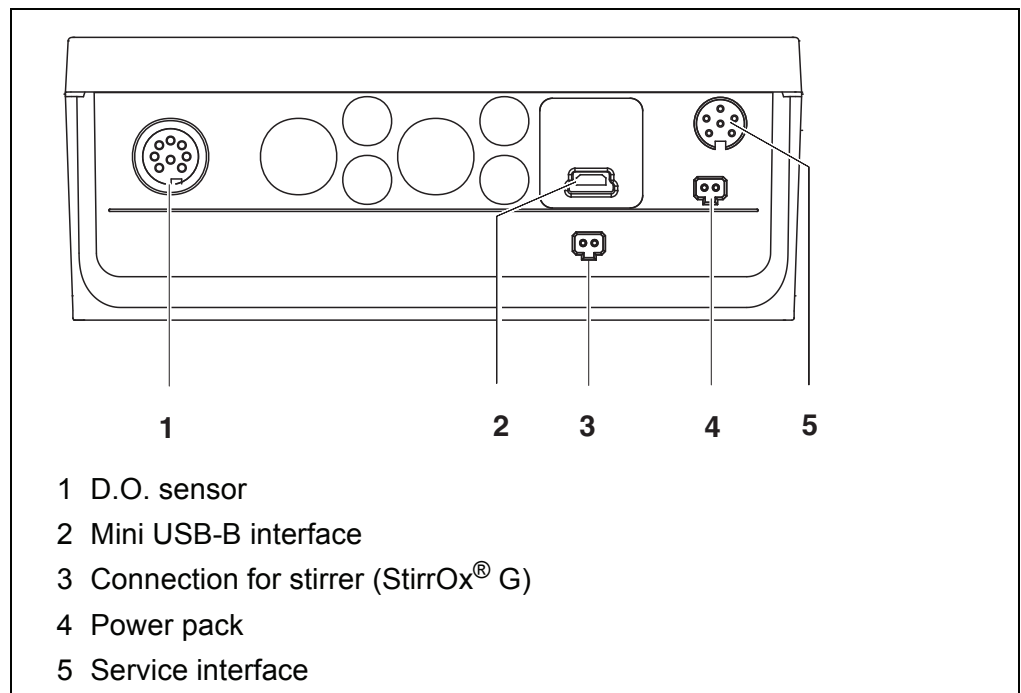

CAUTION

Only connect D.O. sensors to the meter that cannot return any voltages or currents that are not allowed (> SELV and > current circuit with current limiting).
 Almost all customary D.O. sensors fulfill these conditions.

4.2 Switching on the meter

1. Switch the meter on with <On/Off>. The meter performs a self-test. The display shows the manufacturer's logo while the self-test is being performed. The measured value display appears.

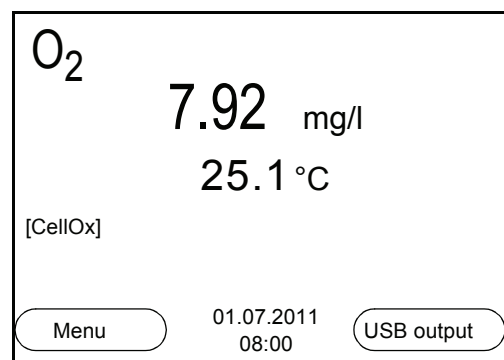

4.3 Switching off

1. Switch the meter off with **<On/Off>**.

Automatic switch-off function

The instrument has an automatic switch-off function in order to save the batteries (see section 6.2.1 SYSTEM, page 32). The automatic switch-off function switches off the meter if no key is pressed for an adjustable period.

The automatic switch-off function is not active

- if the communication cable is connected
- if the *Automatic data storage* function is active, or with *automatic data transmission*
- if the power pack is connected

Display illumination

The meter automatically switches off the display illumination if no key is pressed for 30 seconds. The illumination is switched on with the next keystroke again.

You can also generally switch the display illumination on or off (see section 6.2.1 SYSTEM, page 32).

4.4 Navigation

The principles of navigation in menus and dialogs are explained in the following sections.

4.4.1 Operating modes

The meter has the following operating modes:

Operating mode	Description
Measuring	The measurement data of the connected sensor are shown in the measured value display
Calibration	The course of a calibration with calibration information, functions and settings is displayed
Storing in memory	The meter stores measuring data automatically or manually
Transmitting data	The meter transmits measuring data and calibration records to a USB-B interface automatically or manually.
Setting	The system menu or a sensor menu with submenus, settings and functions is displayed

Only those displays and functions are available in the active operating mode that are currently being required.

4.4.2 Measured value display

In the measured value display, open the setting menus with the **<F1>** softkey. The current functions of the softkeys are shown on the display.

- Use **<F1>/[Menu]** (short pressure) to open the menu for calibration and measurement settings for the displayed measured parameter.
- Use **<F1_>/[Menu]** (long pressure (approx. 2 s) to open the *Storage & config* menu with the sensor-independent settings.

Use the keys of the keypad to carry out further functions such as storage or calibration (see section 4.1.1 KEYPAD, page 13). These functions are not available in other operating situations.

4.4.3 Menus and dialogs

The menus for settings and dialogs in procedures contain further subelements.

- To select a subelement, use the **<▲><▼>** keys. The current selection is displayed with a frame.
- To make further settings, switch to the next higher menu level with **<F1>[Back]**.
- Use **<M>** to return to the measured value display.

4.4.4 Elements in menus and dialogs

- Submenus

The name of the submenu is displayed at the upper edge of the frame. Submenus are opened by confirming with **<ENTER>**. Example:

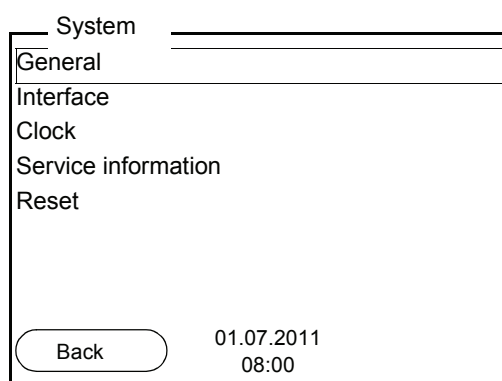

- Settings

Settings are indicated by a colon. The current setting is displayed on the right-hand side. The setting mode is opened with **<ENTER>**. Subsequently, the setting can be changed with **<▲><▼>** and **<ENTER>**. Example:

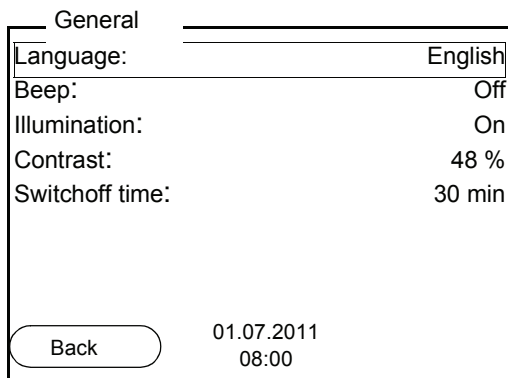

- **Functions**

Functions are designated by the name of the function. They are immediately carried out by confirming with **<ENTER>**.

Example: Display the *Calibration record* function.

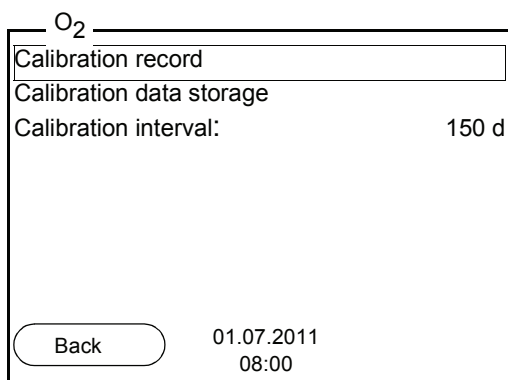

- **Messages**

Information is marked by the **i** symbol. It cannot be selected. Example:

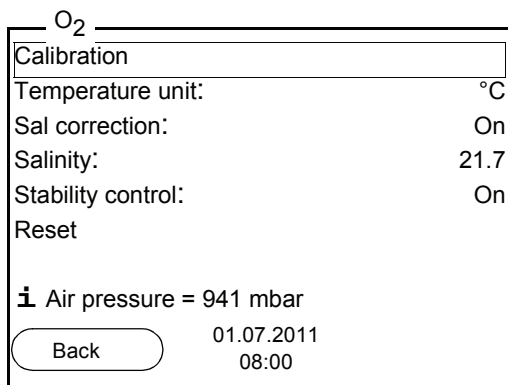

4.4.5 Example 1 on navigation: Setting the language

1. Press the **<On/Off>** key.
The measured value display appears.
The instrument is in the measuring mode.

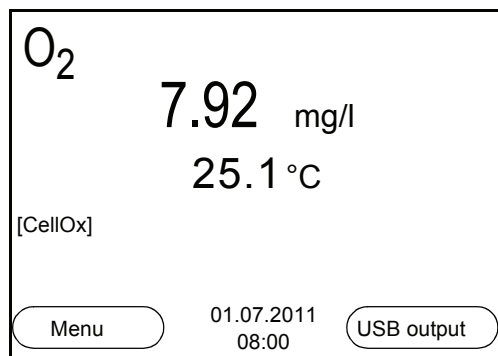

2. Using **<F1_>/[Menu]**, open the *Storage & config* menu.
The instrument is in the setting mode.

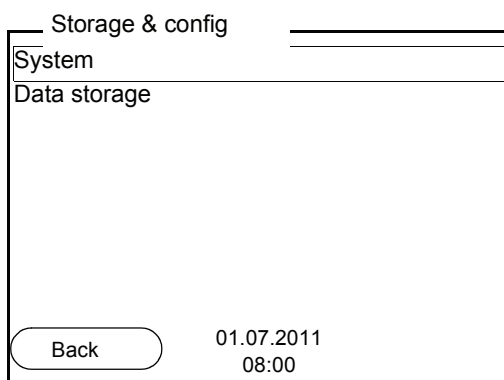

3. Select the *System* submenu with **<▲><▼>**.
The current selection is displayed with a frame.
4. Open the *System* submenu with **<ENTER>**.

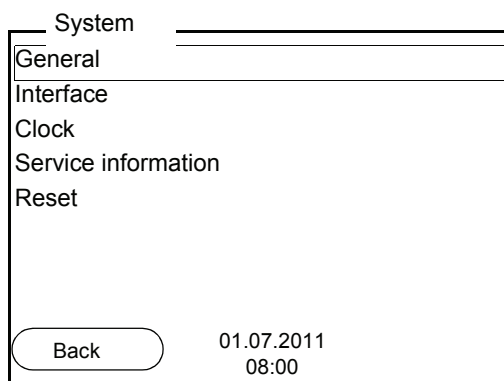

5. Select the *General* submenu with **<▲><▼>**.
The current selection is displayed with a frame.

6. Open the *General* submenu with **<ENTER>**.

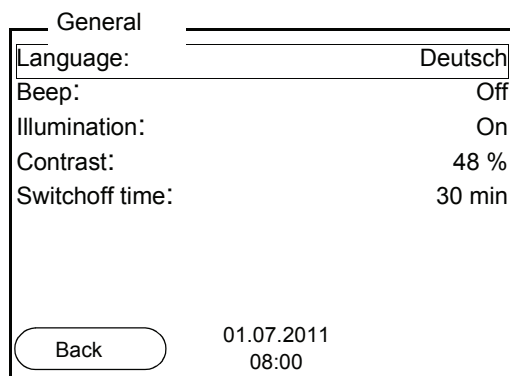

7. Open the setting mode for the *Language* with **<ENTER>**.

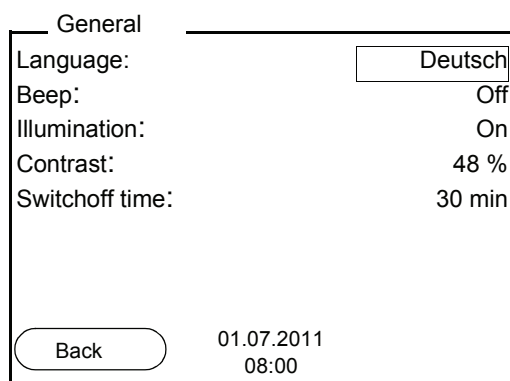

8. Select the required language with **<▲><▼>**.
9. Confirm the setting with **<ENTER>**.
The meter switches to the measuring mode.
The selected language is active.

4.4.6 Example 2 on navigation: Setting the date and time

The measuring instrument has a clock with a date function. The date and time are shown in the measured value display.

When storing measured values and calibrating, the current date and time are automatically stored as well.

The correct setting of the date and time and date format is important for the following functions and displays:

- Current date and time
- Calibration date
- Identification of stored measured values.

Therefore, check the time at regular intervals.



After a fall of the supply voltage (empty batteries), the date and time are reset to 01.01.2011 00, 00:00 hours.

Setting the date, time and date format

The date format can be switched from the display of day, month, year (*dd.mm.yyyy*) to the display of month, day, year (*mm/dd/yyyy* or *mm.dd.yyyy*).

1. In the measured value display:
Using **<F1>**/[Menu], open the *Storage & config* menu.
The instrument is in the setting mode.
2. Select and confirm the *System / Clock* menu with **<▲>****<▼>** and **<ENTER>**.
The setting menu for the date and time opens up.
3. Select and confirm the *Time* menu with **<▲>****<▼>** and **<ENTER>**.
The hours are highlighted.

Clock	
Date format:	dd.mm.yyyy
Date:	01.07.2011
Time:	08:00:25
<div style="display: flex; justify-content: space-between; align-items: center;"> Back 01.07.2011 08:00 </div>	

4. Change and confirm the setting with **<▲>****<▼>** and **<ENTER>**.
The minutes are highlighted.
5. Change and confirm the setting with **<▲>****<▼>** and **<ENTER>**.
The seconds are highlighted.
6. Change and confirm the setting with **<▲>****<▼>** and **<ENTER>**.
The time is set.
7. If necessary, set the *Date* and *Date format*. The setting is made similarly to that of the time.
8. To make further settings, switch to the next higher menu level with **[Back]****<F1>**.
or
Switch to the measured value display with **<M>**.
The instrument is in the measuring mode.

5 Dissolved oxygen

5.1 Measuring

5.1.1 Measuring D.O.

NOTE

When connecting a grounded PC/printer, measurements cannot be performed in grounded media as the values would be incorrect. The USB interface is not galvanically isolated.

1. Connect the D.O. sensor to the meter.
The D.O. measuring screen is displayed.



D.O. measurements can be carried out with the CellOx 325 / StirrOx[®] G or DurOx 325 D.O. sensor.

The meter automatically recognizes the type of the connected D.O. sensor.

2. If necessary, select the measured parameter with **<M>**.
3. Immerse the D.O. sensor in the test sample.

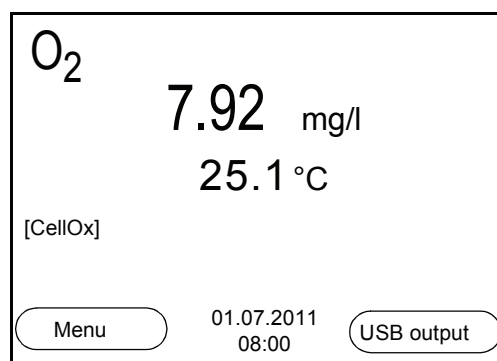

4. If necessary, select the measured parameter with **<M>**.
 - D.O. concentration [mg/l]
 - D.O. saturation [%]
 - D.O. partial pressure [mbar].

Salinity correction

When measuring the concentration of solutions with a salt content of more than 1 g/l, a salinity correction is required. For this, you have to measure and input the salinity of the measured medium first. When the salinity correction is switched on, the *[SAL]* indicator is displayed in the measuring screen.



You can switch the salinity correction on or off and enter the salinity in the menu for calibration and measurement settings (see section 6.1.1 CHANGING THE SETTINGS FOR D.O. SENSORS, page 30).

Stability control (AutoRead) & HOLD function

The stability control function (*AutoRead*) continually checks the stability of the measurement signal. The stability has a considerable impact on the reproducibility of measured values.

The measured parameter flashes on the display

- as soon as the measured value is outside the stability range
- when the automatic *Stability control* is switched off.

You can activate or switch off the automatic *Stability control* function (see section 6.1.1 CHANGING THE SETTINGS FOR D.O. SENSORS, page 30).

1. Freeze the measured value with **<AR>**.
The [HOLD] status indicator is displayed.
The HOLD function is active.



You can terminate the *Stability control* function and the HOLD function with **<AR>** or **<M>** at any time.

2. Using **<ENTER>**, activate the *Stability control* function manually. The [AR] status indicator appears while the measured value is assessed as not stable. A progress bar is displayed and the display of the measured parameter flashes. The [HOLD][AR] status indicator appears as soon as a stable measured value is recognized. The progress bar disappears and the display of the measured parameter stops flashing. The current measurement data is output to the interface. Measurement data meeting the stability control criterion is marked by AR.



You can prematurely terminate the *Stability control* function manually with **<ENTER>** at any time. If the *Stability control* function is prematurely terminated, the current measurement data are output to the interface without the AutoRead info.

3. Using **<ENTER>**, start a further measurement with stability control.
or
Release the frozen measured value again with **<AR>** or **<M>**.
The [AR] status display disappears. The display switches back to the previous indication.

Criteria for a stable measured value

The *Stability control* function checks whether the measured values are stable within the monitored time interval.

Measured parameter	Time interval	Stability in the time interval
D.O. concentration	10 seconds	Δ : better than 0.05 mg/l
D.O. saturation	10 seconds	Δ : better than 0.6 %
D.O. partial pressure	10 seconds	Δ : Better than 1.2 mbar

The minimum duration until a measured value is assessed as stable is the monitored time interval. The actual duration is mostly longer.

5.1.2 Measuring the temperature

For reproducible D.O. measurements, it is essential to measure the temperature of the test sample.

The temperature is automatically measured by the temperature sensor (NTC30 or Pt1000) integrated in the sensor.



The Cellox 325 / StirrOx[®] G and DurOx 325 D.O. sensors have an integrated temperature sensor.

5.2 Calibration

5.2.1 Why calibrate?

D.O. probes age. This changes the slope of the D.O. sensor. Calibration determines the current slope of the sensor and stores this value in the instrument.

5.2.2 When to calibrate?

- After connecting a sensor
- Routinely within the framework of the company quality assurance
- When the calibration interval has expired

5.2.3 Calibration procedures

The Oxi 7310 provides 2 calibration procedures:

- Calibration in water vapor-saturated air.
Use an OxiCal[®] air calibration vessel for calibration.
- Calibration via a comparison measurement (e.g. Winkler titration according to DIN EN 25813 or ISO 5813). At the same time, the relative slope is adapted to the comparison measurement by a correction factor. When the correction factor is active, the *[Factor]* indicator appears in the measuring screen.

5.2.4 Calibration in water vapor-saturated air (air calibration vessel)

For this calibration procedure, the *Comparison meas.* setting must be set to *Off* in the *Calibration* menu.

Proceed as follows to calibrate the instrument:

1. Connect the D.O. sensor to the meter.
2. Put the D.O. sensor into the air calibration vessel.



The sponge in the air calibration vessel must be moist (not wet). Leave the sensor in the air calibration vessel for a time long enough to adjust.

3. Start the calibration with **<CAL>**.
The last calibration data (relative slope) is displayed.

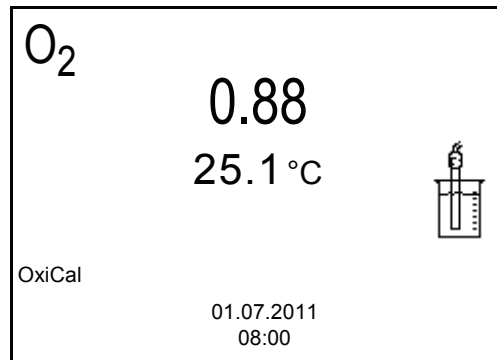

4. Start the measurement with **<ENTER>**.
The measured value is checked for stability (stability control).
The [AR] status indicator is displayed. A progress bar is displayed and the display of the measured parameter flashes.
5. Wait for the end of the measurement with stability control or accept the calibration value with **<ENTER>**.
The calibration record is displayed and output to the interface.
6. Using **<F1>**/*[Continue]* or **<ENTER>**, switch to the measured value display.
The meter displays a D.O. saturation of approx. 101.7 % in the air calibration vessel.

5.2.5 Calibrating with a Comparison meas. (OxiComp)

For this calibration procedure, the *Comparison meas.* setting must be set to *On* in the *Calibration* menu.



Before calibrating via a comparison measurement, the sensor should be calibrated in the air calibration vessel.

1. Connect the D.O. sensor to the meter.
2. Immerse the D.O. sensor in the reference solution.
3. Start the calibration with **<CAL>**.

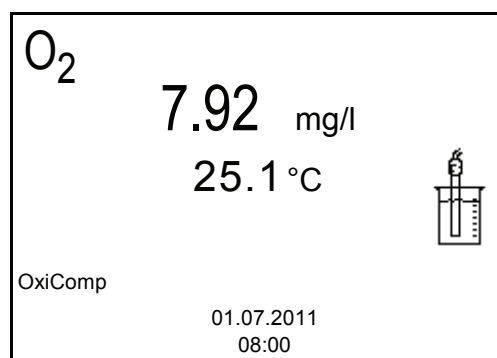

4. Start the measurement with **<ENTER>**.
The measured value is checked for stability (stability control).
The [AR] status indicator is displayed. The measured parameter flashes.
5. Wait for the end of the measurement with stability control or accept the calibration value with **<ENTER>**.
The factor that was set last is displayed.

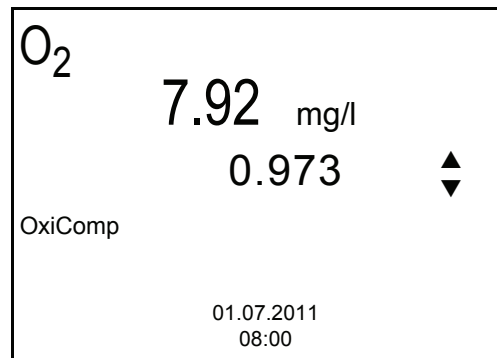

6. Using **<▲>** **<▼>**, set the correction factor to adjust the displayed concentration value to the nominal value (value of the comparison measurement). Subsequently, accept the correction factor with **<ENTER>**.
The meter switches to the measured value display.
The status display [*Factor*] is active.

5.2.6 Calibration data



The calibration record is automatically transmitted to the interface after calibrating.

Displaying the calibration data

The calibration record of the last calibration is to be found under the menu item, **<F1> / [Menu] / Calibration / Calibration record**. To open it, press the **<CAL_>** key in the measured value display.

Subsequently, you can transmit the displayed calibration data to the interface, e. g. to a PC, with **<F2>[USB output]**.



Displaying the calibration data storage

The calibration records of the last calibrations (up to 10) are available in the menu, **<F1>/[Menu] / Calibration / Calibration data storage** and in the menu, **<F1_>/[Menu] / Storage & config/Data storage / Calibration data storage**.

Menu item	Setting/function	Description
<i>Calibration / Calibration data storage /Display</i> or <i>Data storage / Calibration data storage /Display</i>	-	Displays the calibration record. Further options: <ul style="list-style-type: none"> ● Scroll through the calibration records with <▲><▼>. ● Output the displayed calibration record to the interface with <F2>/[USB output]. ● Quit the display with <F1>/[Back] or <ENTER>. ● Switch directly to the measured value display with <M>.
<i>Calibration / Calibration data storage / Output to USB</i> or <i>Data storage / Calibration data storage /Output to USB</i>	-	Outputs the calibration records to the interface.

Calibration evaluation

After the calibration, the meter automatically evaluates the current status of the calibration. The evaluation appears on the display and in the calibration record.

Display	Calibration record	Relative slope
	+++	$S = 0.8 \dots 1.25$
	++	$S = 0.7 \dots 0.8$
	+	$S = 0.6 \dots 0.7$
<i>Error</i>	<i>Error</i>	$S < 0.6$ or $S > 1.25$
Error elimination (see section 11 WHAT TO DO IF..., page 48)		

Calibration record (example)

```
inoLab Oxi 7310
Ser. no. 11292113

CALIBRATION CelloX
01.07.2011 16:13:33

Ser. no. 10501234
S = 0.88 25.0 °C
Sensor +++
```

Calibration datasets

The Oxi 7310 administrates two sets of calibration data:

- Set 1 for the type, "CelloX": – CelloX 325 / StirrOx® G
- Set 2 for the type, "DurOx": – DurOx 325

Sensors of different types can be calibrated separately from each other. When one sensor type is calibrated, the calibration data of the other type remains stored. The Oxi 7310 recognizes the type of the connected sensor and automatically uses the correct calibration data.

6 Settings

6.1 Measurement settings

6.1.1 Changing the settings for D.O. sensors

The settings are available in the menu for measurement and calibration settings. To open the settings, display the required parameter in the measured value display and press the **<F1>/[menu]** or **<ENTER>** key. After completing the settings, switch to the measured value display with **<M>**.

Default settings are printed in **bold**.

Menu item	Possible setting	Description
<i>Calibration / Calibration record</i>	-	Displays the calibration record of the last calibration.
<i>Calibration / Calibration data storage / Display</i>	-	Displays the calibration record. Further options: <ul style="list-style-type: none"> ● Scroll through the calibration records with <▲><▼>. ● Output the displayed calibration record to the interface with <F2>/[USB output]. ● Output all calibration records to the interface with <F2__>/[USB output]. ● Quit the display with <F1>/[Back] or <ENTER>. ● Switch directly to the measured value display with <M>.
<i>Calibration / Calibration data storage / Output to USB</i>	-	Outputs the calibration records to the interface.
<i>Calibration / Serial number (probe)</i>		Entry of the serial number of the connected sensor. The serial number is output in the calibration record. <ul style="list-style-type: none"> ● Change the content of the highlighted position with <▲><▼>. ● Go to the next position with <F2>/[▶]. ● When the serial number has been completely entered, confirm with <ENTER>.

Menu item	Possible setting	Description
<i>Calibration / Calibration interval</i>	<i>1 ... 14 ... 999 d</i>	<i>Calibration interval</i> for the D.O. sensor (in days). The meter reminds you to calibrate regularly by the flashing sensor symbol in the measuring screen.
<i>Calibration / Comparison meas.</i>	<i>On Off</i>	Enables to adjust the measured value with the aid of a comparison measurement, e.g. Winkler titration. For details, see section 5.2 CALIBRATION, page 25.
<i>Sal correction</i>	<i>On Off</i>	Manual salt content correction for concentration measurements.
<i>Salinity</i>	<i>0.0 ... 70.0</i>	Salinity or salinity equivalent for the salt content correction. This function is only available for concentration measurements if the manual salt content correction is switched on.
<i>Stability control</i>	<i>On Off</i>	Switches on or off the automatic stability control during measurement (see section Stability control (AutoRead) & HOLD function, page 23)
<i>Temperature unit</i>	<i>°C °F</i>	Temperature unit, degrees Celsius or degrees Fahrenheit. All temperatures are displayed with the selected unit.
<i>Reset</i>	-	Resets all sensor settings to the delivery condition (see section 6.3.1 RESETTING THE MEASUREMENT SETTINGS, page 33).

6.1.2 Calibration interval

The calibration evaluation is displayed as a sensor symbol.

The sensor symbol flashes after the adjusted calibration interval has expired. It is still possible to measure.



To ensure the high measuring accuracy of the meter, calibrate after the calibration interval has expired.

Setting the calibration interval

The calibration interval is set to 14 days in the factory. You can change the interval (1 ... 999 days):

1. Open the menu for measurement settings with [Menu]<F1>.
2. In the *Calibration / Calibration interval* menu, set the calibration interval with <▲><▼>.
3. Confirm the setting with <ENTER>.
4. Quit the menu with <M>.

6.2 Sensor-independent settings**6.2.1 System**

To open the *Storage & config* menu, press the <F1_>[Menu] key in the measured value display. After completing the settings, switch to the measured value display with <M>.

Default settings are printed in **bold**.

Menu item	Possible setting	Description
<i>System / General / Language</i>	<i>Deutsch</i> English <i>(further)</i>	Selects the menu language
<i>System / General / Beep</i>	On <i>Off</i>	Switches on/off the beep on key-stroke
<i>System / General / Illumination</i>	Auto <i>On</i> <i>Off</i>	Switches the display illumination on/off
<i>System / General / Contrast</i>	<i>0 ...</i> 50 <i>... 100</i> %	Changes the display contrast
<i>System / General / Switchoff time</i>	<i>10 min ...</i> 1h <i>... 24 h</i>	Adjusts the switch-off time
<i>System / Interface / Baud rate</i>	<i>1200, 2400,</i> 4800 , <i>9600,</i> <i>19200</i>	Baud rate of the data interface
<i>System / Interface / Output format</i>	ASCII <i>CSV</i>	Output format for data transmission For details, see section 8 TRANSMITTING DATA (USB INTERFACE), page 41
<i>System / Interface / Decimal separator</i>	Dot (xx.x) <i>Comma (xx,x)</i>	Decimal separator

Menu item	Possible setting	Description
<i>System / Interface / Output header</i>		Output of a header for <i>Output format: CSV</i>
<i>System / Printer</i>		Settings for the integrated printer of the Oxi 7310 P. For details, see section 9 PRINTER (ONLY OXI 7310P) , page 43
<i>System / Clock</i>	<i>Date format</i> <i>Date</i> <i>Time</i>	Settings of time and date. For details, see section 4.4.6 EXAMPLE 2 ON NAVIGATION: SETTING THE DATE AND TIME , page 20
<i>System / Service information</i>		Hardware version and software version of the meter are displayed.
<i>System / Reset</i>	-	Resets the system settings to the default values. For details, see section 6.3.2 RESETTING THE SYSTEM SETTINGS , page 34

6.2.2 Data storage

This menu contains all functions to display, edit and erase stored measured values and calibration records (see section 7 **DATA STORAGE**, page 35).

6.3 Reset

You can reset (initialize) all sensor settings and sensor-independent settings separately from each other.

6.3.1 Resetting the measurement settings



The calibration data are reset to the default settings together with the measuring parameters. Recalibrate after performing a reset.

The following settings for D.O. measurements are reset to the default settings with the *Reset* function:

Setting	Default settings
Cal. interval	14 d
Comparison meas.	Off
<i>Measured parameter</i>	D.O. concentration

Setting	Default settings
<i>Relative slope (S_{Rel})</i>	1.00
<i>Salinity (value)</i>	0.0
<i>Salinity (function)</i>	Off
Stability control	On
Temperature unit	°C

The sensor settings are reset under the *Reset* menu item in the menu for calibration and measurement settings. To open it, press the <F1>/[Menu] or <ENTER> key in the measured value display.

6.3.2 Resetting the system settings

The following system settings can be reset to the default condition:

Setting	Default settings
Language	English
Beep	On
Baud rate	4800 Baud
Output format	ASCII
Contrast	50 %
Illumination	Auto
Switchoff time	1 h

The system settings are reset in the menu, *Storage & config / System / Reset*. To open the *Storage & config* menu, press the <F1_>/[Menu] key in the measured value display.

7 Data storage

You can transmit measured values (datasets) to the data storage:

- Manual storage (see section 7.1 MANUAL STORAGE, page 35)
- Automatic storage at intervals (see section 7.2 AUTOMATIC STORAGE AT INTERVALS, page 36)

Each storage process transmits the current dataset to the interface at the same time.

7.1 Manual storage

You can transmit a measurement dataset to the data storage as follows. The dataset is at the same time output to the interface:

1. Press the **<STO>** key shortly.
The menu for manual storage appears.

Manual data storage 4 of 500

01.07.2011 11:24:16
 O2 = 7.92 mg/l 25.1 °C AR +++
 Sal = 6.5

ID number: 1

Continue

Back 01.07.2011
08:00

2. If necessary, change and confirm the ID number (1 ... 10000) with **<▲><▼>** and **<ENTER>**.
The dataset is stored. The meter switches to the measured value display.

If the storage is full The following window appears if all 500 storage locations are occupied:

Warning

Data storage full. Erase?

Yes

No

Back 01.07.2011
08:00

You have the following options:

- To erase the entire storage, confirm *Yes*.
- To cancel the storage process and switch to the measured value display, confirm *No*. Then you can e.g. transmit the stored data to a PC (see section 7.3.1 DISPLAYING AND EDITING THE MEASUREMENT DATA STORAGE, page 38) and subsequently erase the storage (see section 7.3.2 ERASING THE MEASUREMENT DATA STORAGE, page 40).

7.2 Automatic storage at intervals

The storage interval (*Interval*) determines the time interval between automatic storage processes. Each storage process transmits the current dataset to the interface at the same time.

Configuring the automatic storage function

1. Press the **<STO_>** key.
The menu for automatic storage appears.

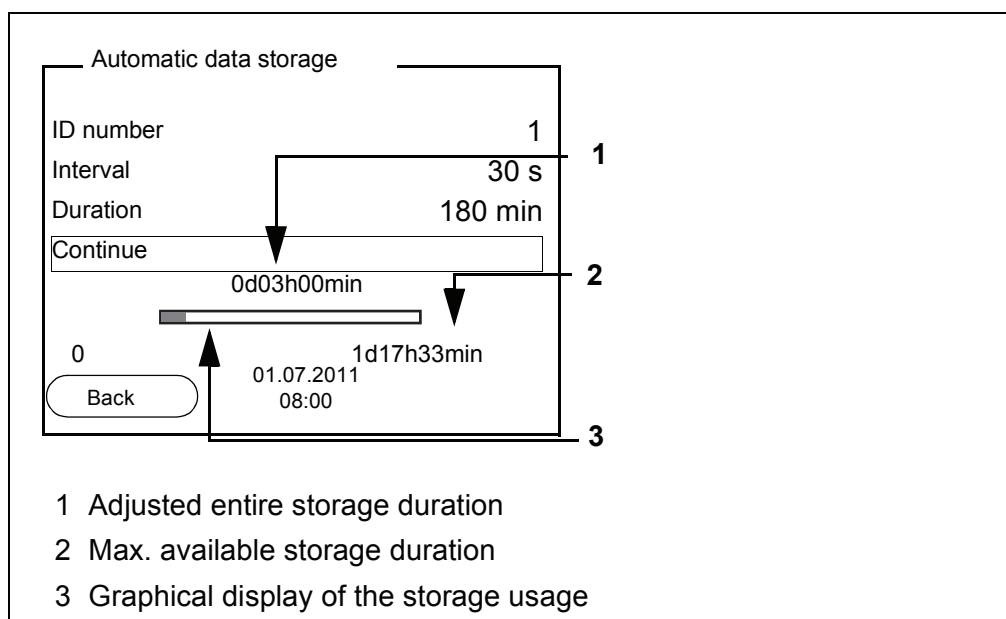

Settings You can configure the automatic storage function with the following settings:

Menu item	Possible setting	Description
ID number	1 ... 10000	ID number for the dataset series.
<i>Interval</i>	1 s, 5 s, 10 s, 30 s, 1 min, 5 min, 10 min, 15 min, 30 min, 60 min	Storage interval. The lower limit of the storage interval can be restricted by the number of free storage locations. The upper limit is restricted by the storage duration.
<i>Duration</i>	1 min ... x min	Storage duration. Specifies after which time the automatic storage should be terminated. The lower limit of the storage duration is restricted by the storage interval. The upper limit is restricted by the number of free storage locations.

Starting the automatic storage function

To start the automatic storage function, select *Continue* with $\langle \blacktriangle \rangle \langle \blacktriangledown \rangle$ and confirm with $\langle \text{ENTER} \rangle$. The meter switches to the measured value display.

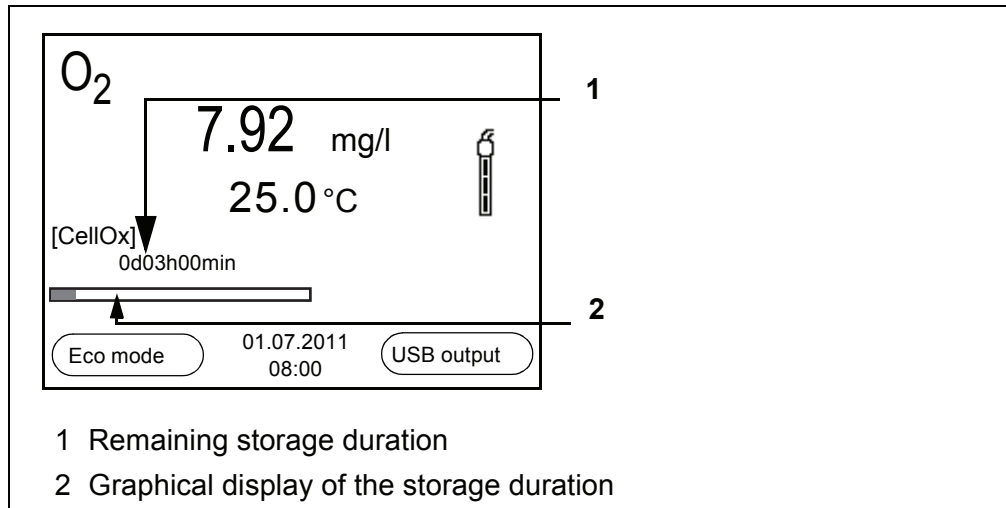

The active automatic storage function can be recognized by the progress bar in the function display. The progress bar indicates the remaining storage duration.



If the automatic storage function is activated, only the following keys are active: Softkeys, $\langle \text{M} \rangle$, $\langle \text{STO}_- \rangle$ and $\langle \text{On/Off} \rangle$. The other keys and the automatic switch-off function are deactivated.

**Energy saving mode
[Eco mode]**

When the automatic storing function is active, the meter provides an energy saving mode [Eco mode] to avoid unnecessary energy consumption. The energy saving mode switches off functions of the meter that are not required for the automatic storage of measurement data (such as the display). By pressing any key the energy saving mode is switched off again.

**Terminating the
automatic storage
function prema-
turely**

Proceed as follows to switch off the automatic storage function before the adjusted storage duration has expired:

1. Press the **<STO_>** key.
The following window appears.

The image shows a rectangular dialog box with a title bar that says "Warning". Inside the box, the text "Stop automatic storage?" is displayed. Below this text are two options: "Yes" and "No". The "No" option is currently selected, indicated by a horizontal line underneath it. At the bottom left of the dialog box is a button labeled "Back". At the bottom right, the date and time "01.07.2011 08:00" are displayed.

2. Using **<▲><▼>**, select Yes and confirm with **<ENTER>**.
The meter switches to the measured value display.
The automatic storage function is terminated.

7.3 Measurement data storage

7.3.1 Displaying and editing the measurement data storage

The contents of the manual or automatic measurement data storage can be shown on the display and output to the interface.

Each of the measurement data storages has a function to erase the entire contents.

**Editing the data stor-
age**

The storage is edited in the menu, *Storage & config / Data storage*. To open the *Storage & config* menu, press the **<F1_>**[Menu] key in the measured value display. Open the manual storage directly with the **<RCL>** key. Open the manual or automatic storage directly with the **<RCL>** or **<RCL_>** key.



The settings are explained here using the manual storage as an example. The same settings and functions are available for the automatic storage.

Settings

Menu item	Setting/ function	Description
<i>Data storage / Manual data storage / Display</i>	-	Displays all measurement datasets page by page. Further options: <ul style="list-style-type: none"> ● Scroll through the datasets with <▲><▼>. ● Output the displayed dataset to the interface with <F2>/[USB output]. ● Quit the display with <F1>/[Back].
<i>Data storage / Manual data storage / Erase</i>	-	Erases the entire manual measurement data storage. All calibration data remains stored when this action is performed.
<i>Data storage / Manual data storage / Output to USB</i>	-	Outputs all stored measurement data to the interface.

Display representation of a dataset

Manual data storage 3 of 64 ◀▶

01.07.2011 11:24:16 ID number: 1

O2 = 7.92 mg/l 25.1 °C AR +++
Sal = 6.5

Back
01.07.2011
08:00
USB output

Representation of a dataset (USB output)

```

01.07.2011 09:27:20
inoLab Oxi 7310
Ser. No. 12345678

ID number 1

O2 = 7.92 mg/l      25.0 °C, AR, S: +++
Sal = 6.5
-----

01.07.2011 09:56:24
inoLab Oxi 7310
Ser. No. 12345678

ID number 1

O2 8.14 mg/l      25.0 °C, AR, S: +++
Sal = 6.5
-----
    
```

Quitting the display To quit the display of stored measurement datasets, you have the following options:

- Switch directly to the measured value display with **<M>**.
- Quit the display and move to the next higher menu level with **<F1>/[Back]**.

7.3.2 Erasing the measurement data storage

Erasing the measurement data storage (see section 7.3.1 DISPLAYING AND EDITING THE MEASUREMENT DATA STORAGE, page 38).

7.3.3 Measurement dataset

A complete dataset includes:

- ID number
- Date/time
- Measured value of the connected sensor
- Measured temperature value of the connected sensor
- AutoRead info: The *AR* indicator appears with the measured value if the AutoRead criterion was met while storing (stable measured value). Otherwise, there is no *AR* indicator.
- Calibration evaluation: +++, ++, +, -, or no evaluation

7.3.4 Storage locations

The Oxi 7310 meter has two measurement data storages. The measured values recorded either manually or automatic are stored separately in individual measurement data storages.

Storage	Maximum number of datasets
<i>Manual data storage</i>	500
<i>Automatic data storage</i>	5000

8 Transmitting data (USB interface)

8.1 Options for data transmission

Via the USB interface you can transmit data to a PC. The following table shows which data are transmitted to the interface in which way:

Data	Control	Operation / description
Current measured values of all connected sensors	Manual	<ul style="list-style-type: none"> ● With <F2>/<i>[USB output]</i>. ● Simultaneously with every manual storage process (see section 7.1 MANUAL STORAGE, page 35).
	Automatic, at intervals	<ul style="list-style-type: none"> ● With <F2__>/<i>[USB output]</i>. Then you can set the transmission interval. ● Simultaneously with every automatic storage process (see section 7.2 AUTOMATIC STORAGE AT INTERVALS, page 36).
Stored measured values	Manual	<ul style="list-style-type: none"> ● Displayed dataset with <F2>/<i>[USB output]</i> after calling up from the storage. ● All datasets with the <i>Output to USB</i> function. <p>Details (see section 7.3.1 DISPLAYING AND EDITING THE MEASUREMENT DATA STORAGE, page 38).</p>
Calibration records	Manual	<ul style="list-style-type: none"> ● Calibration record with <F2>/<i>[USB output]</i>. <p>Details (see section 5.2.6 CALIBRATION DATA, page 28).</p>
	Automatic	<ul style="list-style-type: none"> ● At the end of a calibration procedure.



The following rule applies: With the exception of the menus, shortly pressing the *[USB output]* / **<F2>** key generally outputs the display contents to the interface (displayed measured values, measurement datasets, calibration records).

8.2 Connecting a PC

Connect the Oxi 7310 to the PC via the USB interface.

NOTE:

When connecting an earthed PC/printer, measurements cannot be performed in earthed media as the values would be incorrect. The USB interface is not galvanically isolated.

Installation of the USB driver on the PC

System requirements of the PC for installation of the USB driver:

- PC with Pentium processor or higher with at least one free USB connection and CD-ROM drive
- Windows 2000, XP, Vista, 7.

1. Insert the supplied installation CD in the CD drive of your PC.
2. Install the driver from the CD.
Follow the Windows installation instructions as necessary.
3. Connect the Oxi 7310 to the PC via the USB interface.
The meter is listed as a virtual COM interface among the connections in the Windows instrument manager.

8.3 MultiLab Importer

With the aid of the MultiLab Importer software, you can record and evaluate measuring data with a PC.



More detailed information can be found in the MultiLab Importer operating manual.

9 Printer (only Oxi 7310P)

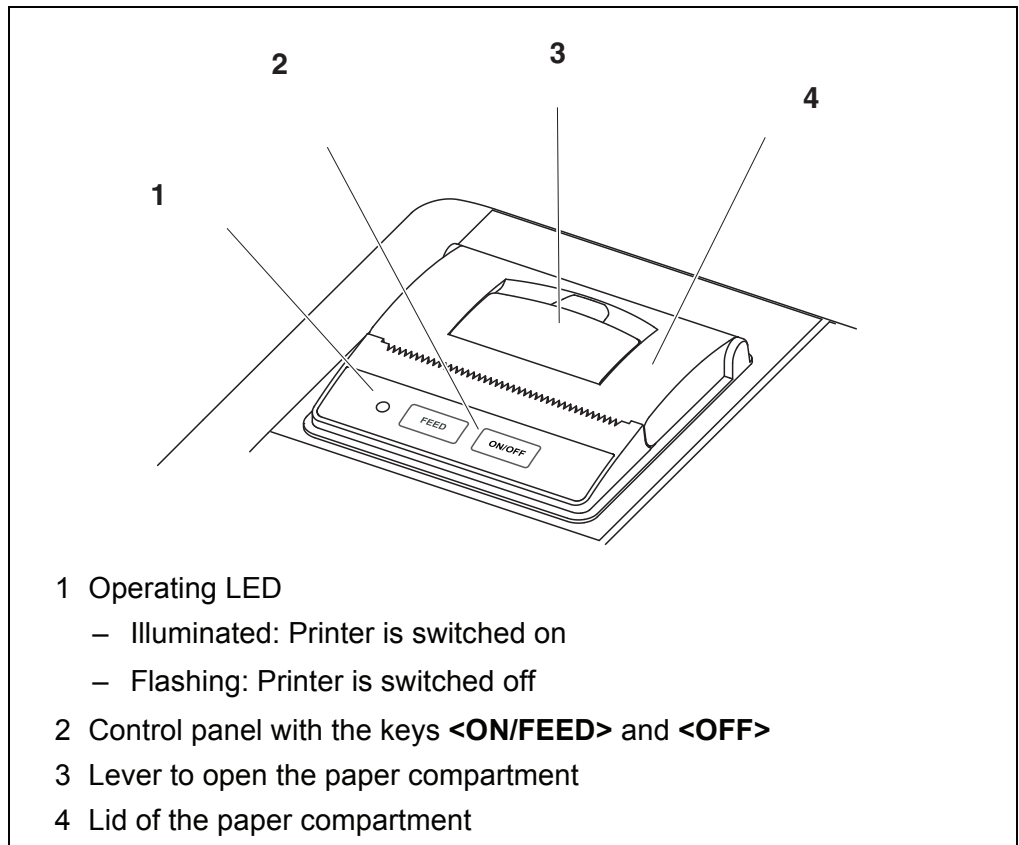

9.1 Commissioning / switching the printer on or off

Switching on the printer

1. Connect the power pack to the Oxi 7310 P.
The LED lights up green. The printer is ready for operation.
or
If the printer was switched off (LED flashing):
Switch on the printer with <OFF>.
The LED lights up green. The printer is ready for operation.



If there is a USB connection (such as to a PC) the data are output only to the PC.

Switching off the printer

1. Switch off the printer with <OFF>.
The LED flashes. The printer is switched off.

9.2 Operation / printing

Data are only output to the printer if the following conditions are met

- Data are transmitted manually or automatically (see section 8.1 OPTIONS FOR DATA TRANSMISSION, page 41)
- the printer is switched on (LED illuminated)
- there is no USB connection.

9.3 Printer settings

To open the *Storage & config* menu, press the <F1_>[Menu] key in the measured value display. After completing the settings, switch to the measured value display with <M>.

Default settings are printed in **bold**.

Menu item	Possible setting	Description
<i>System / Printer / Font size</i>	12x20 8x16 7x16	Select the font size for the printer A print sample (character set of the printer) to view the available font sizes can be printed with <OFF_>.
<i>System / Printer / Print test page</i>	-	The printer prints the meter information from the <i>System / Service information</i> menu. The current printer settings are used for the printout.

9.4 Maintenance

9.4.1 Changing the roll of paper

1. Pull the lever (3) upwards until the lid (4) of the paper compartment opens.
2. If necessary, remove any remains of the old roll of paper.
3. Insert the new roll of paper. The start of the paper should poke out of the paper compartment.
4. Close the lid (4) of the paper compartment so that it clicks into place.
5. If necessary, move the printer paper forward with <ON/FEED>.



Use original WTW rolls of paper only.

You will find information on this in the WTW catalog LABORATORY AND FIELD INFORMATION or on the Internet.

The thermal paper will remain legible for at least 7 years if stored appropriately.

9.5 What to do if... / printer

Integrated printer does not print

Cause	Remedy
– Printer switched off (LED flashing)	– Switch on the printer (LED illuminated)
– No power pack connected	– Connect the power pack
– USB cable connected	– Disconnect the USB cable from the meter
– Function "automatic storing at intervals" with long intervals is switched on	– Switch off the function (see section 7.2 AUTOMATIC STORAGE AT INTERVALS, page 36)
– No paper available	– Insert a roll of paper

Printer operating - paper not being printed

Cause	Remedy
– Paper inserted the wrong way up	– Turn the roll of paper around and insert it with the other side upwards

Integrated printer prints automatically

Cause	Remedy
– The function "Automatic storage at intervals" or "Transmit data automatic at intervals" is switched on	– Switch off the function (see section 7.2 AUTOMATIC STORAGE AT INTERVALS, page 36 or section 8.1 OPTIONS FOR DATA TRANSMISSION, page 41)

10 Maintenance, cleaning, disposal

10.1 Maintenance

10.1.1 General maintenance activities

The only maintenance activity required is replacing the batteries.



See the relevant operating manuals of the D.O. sensors for instructions on maintenance.

10.1.2 Replacing the batteries



You can operate the meter either with normal batteries or with rechargeable batteries (Ni-MH). In order to charge the batteries, an external charging device is required.

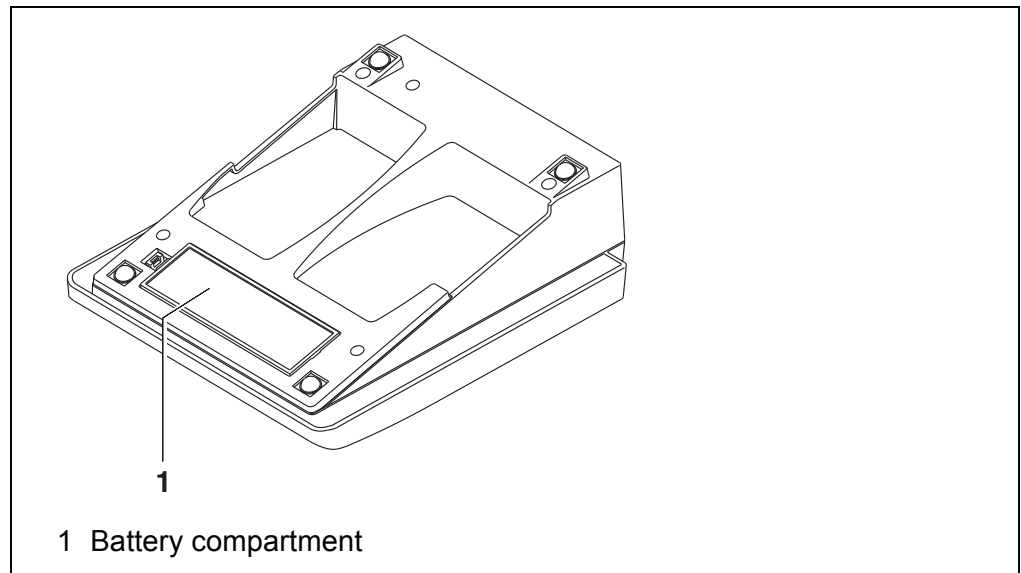

1. Open the battery compartment (1) on the underside of the meter.
2. Remove the four batteries from the battery compartment.
3. Place four new batteries (type Mignon AA) in the battery compartment.



CAUTION

**Make sure that the poles of the batteries are positioned correctly.
The ± signs on the batteries must correspond to the ± signs in the battery compartment.**

4. Close the battery compartment (1).
5. Set the date and time (see section 4.4.6 EXAMPLE 2 ON NAVIGATION: SETTING THE DATE AND TIME, page 20)



When the batteries are nearly empty, the  status indicator is displayed.



Dispose of used batteries according to the local regulations of your country.

End users within the European Union are obligated to return used batteries (even ecologically compatible ones) to a collection point set up for recycling purposes.

Batteries are marked with the crossed-out waste container symbol. Therefore, they may not be disposed with the domestic waste.

10.2 Cleaning

Occasionally wipe the outside of the measuring instrument with a damp, lint-free cloth. Disinfect the housing with isopropanol as required.



CAUTION

The housing is made of synthetic material (ABS). Thus, avoid contact with acetone or similar detergents that contain solvents. Remove any splashes immediately.

10.3 Packing

This meter is sent out in a protective transport packing. We recommend: Keep the packing material. The original packing protects the meter against damage during transport.

10.4 Disposal

At the end of its operational lifetime, the meter must be returned to the disposal or return system statutory in your country. If you have any questions, please contact your supplier.

11 What to do if...

11.1 Dissolved oxygen



More information and instructions on cleaning and exchange of sensors are given in the documentation of your sensor.

Error message, *OFL, UFL*

The measured value is outside the measuring range.

Cause	Remedy
<ul style="list-style-type: none"> – Measured value outside the measuring range of the meter 	<ul style="list-style-type: none"> – Use a suitable D.O. sensor

Error message, *Error*

Cause	Remedy
<ul style="list-style-type: none"> – D.O. sensor contaminated – Electrolyte depleted 	<ul style="list-style-type: none"> – Clean the D.O. sensor. – Changing the electrolyte and membrane cap – If necessary, replace the D.O. sensor

Error message, *Leak*

Cause	Remedy
<ul style="list-style-type: none"> – Membrane cap not screwed on tight enough – Hole in the membrane 	<ul style="list-style-type: none"> – Screw membrane head tighter – Replace and refill the membrane cap

11.2 General information

Sensor symbol flashes

Cause	Remedy
<ul style="list-style-type: none"> – Calibration interval expired 	<ul style="list-style-type: none"> – Recalibrate the measuring system



Display

Cause	Remedy
<ul style="list-style-type: none"> – Batteries almost empty 	<ul style="list-style-type: none"> – Replace the batteries (see section 10.1 MAINTENANCE, page 46)

Instrument does not react to keystroke	Cause <ul style="list-style-type: none">– Operating condition undefined or EMC load unallowed	Remedy <ul style="list-style-type: none">– Processor reset: Press the <ENTER> and <On/Off> key simultaneously
You want to know which software version is in the meter	Cause <ul style="list-style-type: none">– E. g., a question by the service department	Remedy <ul style="list-style-type: none">– Switch on the meter. Open the menu, <F1_>/ [Menu] / <i>Storage & config / System / Service information</i>. The instrument data are displayed.

12 Technical data

12.1 Measuring ranges, resolution, accuracy

Measuring ranges, resolution

The values quoted in brackets apply especially to the DurOx 325 sensor.

Parameter	Measuring range	Resolution
D.O. concentration [mg/l]	0 ... 20.00 (0 ... 20.0) 0 ... 90.0 (0 ... 90)	0.01 (0.1) 0.1 (1)
Saturation [%]	0 ... 200.0 (0 ... 200) 0 ... 600	0.1 (1) 1
D.O. partial pressure [mbar]	0 ... 200.0 (0 ... 200) 0 ... 1250	0.1 (1) 1
T [°C]	0 ... 50.0	0.1

Accuracy (± 1 digit)

Parameter	Accuracy
D.O. concentration [mg/l]	± 0.5 % of measured value at ambient temperature + 5 °C ... + 30 °C
D.O. Saturation [%]	± 0.5% of measured value when measuring in the range of ± 10 K around the calibration temperature
D.O. partial pressure [mbar]	± 0.5 % of measured value at ambient temperature + 5 °C ... + 30 °C

T [°C] / temperature sensor

NTC 30	± 0.1
PT 1000	± 0.1

Correction functions

Temperature compensation	Accuracy better than 2 % at 0 ... + 40 °C
Salinity correction	0 ... 70.0 SAL
Air pressure correction	Automatic through integrated pressure sensor in the range of 500 ... 1100 mbar



The accuracy values specified here apply exclusively to the meter. The accuracy of the used D.O. sensor has also to be taken into account.

12.2 General data

Dimensions

Oxi 7310:	Approx. 240 x 190 x 80 mm
Oxi 7310 P:	Approx. 290 x 190 x 80 mm

Weight

Oxi 7310:	Approx. 0.8 kg
Oxi 7310 P:	Approx. 1.0 kg

Mechanical structure	Type of protection	IP 43
	Electrical safety	Protective class
Test certificates	CE	
Ambient conditions	Storage	- 25 °C ... + 65 °C
	Operation	+5 °C ... + 45 °C
	Admissible relative humidity	Yearly mean: < 75 % 30 days/year: 95 % Other days: 85 %
Power supply	Batteries	4 x 1.5 V alkali-manganese batteries, type AA
	Rechargeable batteries	4 x 1.2 V NiMH rechargeable batteries, type AA (no charging function)
	Operational life	Up to 800 h without / 100 h with illumination
	Power pack	Kuantech Co. Ltd. KSAC 0900110W1UV-1 Input: 100 ... 240 V ~ / 50 ... 60 Hz / 270 mA Output: 9 V = / 1.1 A Connection max. overvoltage category II Primary plugs contained in the scope of delivery: Euro, US, UK and Australian.
USB interface	Type	USB 1.1 USB B (device), data output
	Baud rate	Adjustable: 1200, 2400, 4800, 9600, 19200 Baud
	Data bits	8
	Stop bits	2
	Parity	None
	Handshake	RTS/CTS
	Cable length	Max. 3 m
Guidelines and norms used	EMC	EC directive 2004/108/EC EN 61326-1 EN 61000-3-2 EN 61000-3-3 FCC Class A
	Meter safety	EC directive 2006/95/EC EN 61010-1
	IP protection class	EN 60529

FCC Class A Equipment Statement

Note: This equipment has been tested and found to comply with the limits for a Class A digital device, pursuant to Part 15 of the FCC Rules. These limits are designed to provide reasonable protection against harmful interference when the equipment is operated in a commercial environment. This equipment generates, uses, and can radiate radio frequency energy and, if not installed and used in accordance with the instruction manual, may cause harmful interference to radio communications. Operation of this equipment in a residential area is likely to cause harmful interference in which case the user will be required to correct the interference at his own expense.

Changes or modifications not expressly approved by the manufacturer could void the user's authority to operate the equipment.

13 Firmware update

Available firmware updates are provided on the Internet.

With the firmware update program and a PC you can update the firmware of the Oxi 7310 to the newest version.

For the update you have to connect the meter to a PC.

For the update via the USB interface, the following is required:

- a free USB interface (virtual COM port) on the PC
- the driver for the USB interface (on the enclosed CD-ROM)
- the USB cable (included in the scope of delivery of the Oxi 7310).

1. Install the downloaded firmware update on a PC.
An update folder is created in the Windows start menu.
If an update folder already exists for the meter (or meter type), the new data is displayed there.
2. In the windows start menu, open the update folder and start the firmware update program.
3. Using the USB interface cable, connect the Oxi 7310 to a USB interface (virtual COM port) of the PC.
4. Switch on the Oxi 7310.
5. In the firmware update program, start the update process with OK.
6. Follow the instructions of the firmware update program.
During the programming process, a corresponding message and a progress bar (in %) are displayed.
The programming process takes approx. three minutes. A terminatory message is displayed after a successful programming process. The firmware update is completed.
7. Disconnect the Oxi 7310 from the PC.
The Oxi 7310 is ready for operation again.

After switching the meter off and on you can check whether the meter has taken over the new software version (see YOU WANT TO KNOW WHICH SOFTWARE VERSION IS IN THE METER, PAGE 49).

14 Glossary

Dissolved oxygen

D.O. partial pressure	Pressure caused by the oxygen in a gas mixture or liquid.
D.O. saturation	Short name for the "relative D.O. saturation".
OxiCal®	WTW name for a procedure to calibrate D.O. measuring systems in water vapor saturated air.
Salinity	The absolute salinity S_A of seawater corresponds to the relationship of the mass of dissolved salts to the mass of the solution (in g/kg). In practice, this dimension cannot be measured directly. Therefore, the practical salinity according to IOT is used for oceanographic monitoring. It is determined by measuring the electrical conductivity.
Salt content	General designation for the quantity of salt dissolved in water.
Slope (relative)	Designation used by WTW in the D.O. measuring technique. It expresses the relation of the slope value to the value of a theoretical reference sensor of the same construction type.

General information

Adjusting	To manipulate a measuring system so that the relevant value (e. g. the displayed value) differs as little as possible from the correct value or a value that is regarded as correct, or that the difference remains within the tolerance.
AutoRange	Name of the automatic selection of the measuring range.
Calibration	Comparing the value from a measuring system (e. g. the displayed value) to the correct value or a value that is regarded as correct. Often, this expression is also used when the measuring system is adjusted at the same time (see adjusting).
Measured parameter	The measured parameter is the physical dimension determined by measuring, e. g. pH, conductivity or D.O. concentration.
Measured value	The measured value is the special value of a measured parameter to be determined. It is given as a combination of the numerical value and unit (e. g. 3 m; 0.5 s; 5.2 A; 373.15 K).
Molality	Molality is the quantity (in Mol) of a dissolved substance in 1000 g solvent.
Reset	Restoring the original condition of all settings of a measuring system.
Resolution	Smallest difference between two measured values that can be displayed by a meter.
Stability control (AutoRead)	Function to control the measured value stability.

Standard solution	The standard solution is a solution where the measured value is known. It is used to calibrate a measuring system.
Temperature function	Name of a mathematical function expressing the temperature behavior of a test sample, a sensor or part of a sensor.
Test sample	Designation of the test sample ready to be measured. Normally, a test sample is made by processing the original sample. The test sample and original sample are identical if the test sample was not processed.

15 Index

A

Air calibration beaker	25
Automatic switch-off	16
AutoRead	23

B

Battery compartment	11, 46
---------------------------	--------

C

Calibration evaluation	28
Calibration interval	31
Comparison measurement (D.O.)	25
Connecting a PC	42

D

Dataset	40
Date and time	20
Default settings	
Measured parameter	33
System settings	34
Display	14

E

Energy saving mode	38
--------------------------	----

F

Firmware update	53
-----------------------	----

I

Initial commissioning	10
Initialize	33
Interval for calibration	31

K

Keys	13
------------	----

M

Measured value display	17
Measurement accuracy	31
Measurement data storage	
Edit	38
Erase	38
Storage locations	40
Measurement dataset	40
Measuring	22
Menus (navigation)	17
Messages	18

P

Print	41
Printer (only Oxi 7310P)	43

R

Reset	33
-------------	----

S

Scope of delivery	10
Slope, relative	25
Socket field	15
Storage interval	36
Storing in memory	35
At intervals	36
Automatic	36
Manual	35

T

Temperature measurement	24
Transmitting data	41
automatic	41
manual	41
Transmitting measured values	41



Wissenschaftlich-Technische Werkstätten GmbH

Dr.-Karl-Slevogt-Straße 1
D-82362 Weilheim

Germany

Tel: +49 (0) 881 183-0
 +49 (0) 881 183-100
Fax: +49 (0) 881 183-420
E-Mail: Info@WTW.com
Internet: <http://www.WTW.com>