

memmert

ICH

ICH L

ICH eco

ICH L eco

**OPERATING
INSTRUCTIONS**

CLIMATE CHAMBER ICH
ICH L
ICH ECO
ICH L ECO

MADE IN GERMANY.

www.memmert.com



Manufacturer and customer service

Memmert GmbH + Co. KG
Willi Memmert Straße 90-96
D-91186 Büchenbach
Deutschland

Phone: +49 (0)9122 925-0
Fax: +49 (0)9122 14585
E-mail: sales@memmert.com
Internet: www.memmert.com

Customer service:

Service hotline: +49 (0)9171 9792 911
Service fax: +49 (0)9171 9792 979
E-mail: service@memmert.com

When contacting customer service, always quote the product serial number on the nameplate (see page 13).

Shipping address for repairs:

Memmert GmbH + Co. KG
Kundenservice
Willi-Memmert-Str. 90-96
DE-91186 Büchenbach
Germany

Please contact our customer service before sending appliances for repair or before returning equipment, otherwise, we have to refuse acceptance of the shipment.

© 2019 MEMMERT GmbH + Co. KG

D33142 | Date 12/2019

We reserve the right to make changes

About this manual

Purpose and target audience

This manual describes the setup, function, transport, operation and maintenance of climate chambers ICH, ICH eco, ICH L and ICH L eco. It is intended for use by trained personnel of the owner, who have the task of operating and/or maintaining the respective appliance.

If you are asked to work on the appliance, read this manual carefully before starting. Familiarise yourself with the safety regulations. Only perform work that is described in this manual. If there is something you do not understand, or certain information is missing, ask your manager or contact the manufacturer. Do not do anything without authorisation.

Versions

The appliances are available in different configurations and sizes. If specific equipment features or functions are available only for certain configurations, this is indicated at the relevant points in this manual.

The functions described in this manual refer to the latest firmware version.

Due to individual configurations and sizes, illustrations in this manual may be slightly different from the actual appearance. Function and operation are identical.

Other documents that have to be observed:

- ▶ For operation of the appliance with MEMMERT AtmoCONTROL, observe the separate software manual. To open the AtmoCONTROL software manual, click on "Help" in the AtmoCONTROL menu bar.
- ▶ For service and repair work (see page 59), observe the separate service manual

Storage and resale

This instruction manual belongs with the appliance and should always be stored where persons working on the appliance have access to it. It is the responsibility of the owner to ensure that persons who are working or will work on the appliance are informed as to the whereabouts of this instruction manual. We recommend that it is always stored in a protected location close to the appliance. Make sure that the instruction manual is not damaged by heat or humidity. If the appliance is resold or transported and then set up again at a different location, the operating instructions must go with it.

For the current version of this operating manual in pdf format, please go to www.memmert.com/de/service/downloads/bedienungsanleitung/.

Contents

1. For your Safety	6
1.1 Terms and signs used.....	6
1.2 Product safety and dangers	7
1.3 Safety labels.....	8
1.4 Requirements of the operating personnel.....	8
1.5 Responsibility of the owner.....	8
1.6 Intended use.....	9
1.7 Changes and conversions.....	9
1.8 Behaviour in case of malfunctions and irregularities.....	9
1.9 Switching off the appliance in an emergency	9
2. Construction and description	10
2.1 Construction	10
2.2 Construction and function	11
2.3 Material.....	11
2.4 Electrical equipment.....	11
2.5 Connections and interfaces.....	11
2.6 Designation (nameplate).....	13
2.7 Technical data	14
2.8 Applied directives and standards	15
2.9 Declaration of conformity	15
2.10 Ambient conditions	16
2.11 Scope of delivery	16
2.12 Optional accessories.....	16
3. Delivery, transport and setting up	17
3.1 For your Safety.....	17
3.2 Delivery	18
3.3 Transport.....	18
3.4 Unpacking	18
3.5 Storage after delivery	18
3.6 Setting up	19
4. Putting into operation	22
4.1 Connecting the appliance	22
4.2 Fill up and connect the water tank	22
4.3 Switching on.....	23
5. Operation and control	24
5.1 Operating personnel.....	24
5.2 Opening the door.....	24
5.3 Loading the appliance.....	25
5.4 Operating the appliance.....	26
5.5 Monitoring function.....	32
5.6 Graph.....	37
5.7 Ending operation.....	38

6. Malfunctions, warning and error messages	39
6.1 Warning messages of the monitoring function.....	39
6.2 Malfunctions, operating problems and appliance errors	41
6.3 Power failure.....	42
7. Menu mode	43
7.1 Overview.....	43
7.2 Basic operation in menu mode using the example of language selection.....	44
7.3 Setup.....	45
7.4 Date and Time	49
7.5 Calibration	51
7.6 Program.....	55
7.7 Sound	56
7.8 Protocol	57
7.9 User-ID	58
8. Maintenance and Servicing	59
8.1 Cleaning.....	59
8.2 Repairs and Service.....	61
9. Storage and disposal	65
9.1 Storage	65
9.2 Disposal	65
Index	66

1. For your Safety

1.1 Terms and signs used

In this manual and on the appliance itself, certain common terms and signs are used to warn you of possible dangers or to give you hints that are important in avoiding injury or damage. Observe and follow these hints and regulations to avoid accidents and damage. These terms and signs are explained below.

1.1.1 Terms used

"Warning" is used whenever you or somebody else could be injured if you do not observe the accompanying safety regulation.

"Caution" is used for information that is important for avoiding damage.

1.1.2 Signs used

Warning signs (warning of a danger)

Danger of electrocution	Danger of explosion	Gases / vapours	Danger of toppling over	UV light	Hazard area! Observe the operating instructions

Prohibition signs (forbidding an action)

Do not lift	Do not tilt	Do not enter

Regulation signs (stipulating an action)

Disconnect the mains plug	Wear gloves	Wear safety boots	Wear UV safety goggles	Observe information in separate manual

Other icons

Important or useful additional information

1.2 Product safety and dangers

The appliances described in this manual are technically sophisticated, manufactured using high-quality materials and subject to many hours of testing in the factory. They contain the latest technology and comply with recognised technical safety regulations. However, there are still risks involved, even when the appliances are used as intended. These are described below.



Warning!

After removing covers, live parts may be exposed. You may receive an electric shock if you touch these parts. Disconnect the mains plug before removing any covers. Only electrical technicians may work on the electrical equipment of the appliances.



Warning!

When loading the appliance with an unsuitable load, poisonous or explosive vapours or gases may be produced. This could cause the appliance to explode, and people could be severely injured or poisoned. The appliance may only be loaded with materials/test objects which do not form any toxic or explosive vapours when heated up (see also chapter Intended use on page 9).



Warning!

If the door is open while the appliance is in operation, the appliance may overheat and pose a fire hazard. Do not leave the door open during operation.



Warning!

In case of appliances of a certain size, you can get accidentally locked in, which is life-threatening. Do not climb into the appliance!

1.2.1 Additional safety regulation for the model ICH L / ICH L eco



Warning!

UV light is a danger to your eyes. Your eyes could be injured by UV light if you do not wear protection. Always wear UV safety goggles when opening the door of the ICH L / ICH L eco. This is indicated by the warning signs on the door (see Fig. 1).



1.2.2 Additional safety regulations for models ICH eco and ICH L eco



Warning!

Risk of poisoning due to slow refrigerant leakage. If the filling quantity of CO₂ is greater than the maximum filling quantity (filling quantity 375 g), a CO₂ warning device and ventilation in machine rooms must be provided. ICH eco/ICH L eco refrigeration systems may only be installed in rooms of at least 4 m³.

1.3 Safety labels

The model ICH L/ICH L eco has warning labels attached to its door, warning against dangerous UV radiation in the interior (Fig. 1). They indicate that either the lighting has to be switched off or UV safety goggles are required when the door is opened.

These stickers must not be removed and must always be well visible. If they become unrecognisable or if they peel off, they must be replaced. They can be ordered from Memmert customer service.



Fig. 1 Warning sign on the door

1.4 Requirements of the operating personnel

The appliance may only be operated and maintained by persons who are of legal age and have been instructed accordingly. Personnel who are to be trained, instructed or who are undergoing general training may only work with the appliance under the continuous supervision of an experienced person.

Repairs may only be performed by qualified electricians. The regulations in the separate service manual must be observed.

1.5 Responsibility of the owner

The owner of the appliance

- ▶ is responsible for the flawless condition of the appliance and for it being operated in accordance with its intended use (see chapter 1.6);
- ▶ is responsible for ensuring that persons who are to operate or service the appliance are qualified to do this, have been instructed accordingly and are familiar with the operating instructions at hand;
- ▶ must know about the applicable guidelines, requirements and operational safety regulations, and train staff accordingly;
- ▶ is responsible for ensuring that unauthorised persons have no access to the appliance;
- ▶ is responsible for ensuring that the maintenance plan is adhered to and that maintenance work is carried out properly (see page 59);
- ▶ has to ensure that the appliance and its surroundings are kept clean and tidy, for example through corresponding instructions and inspections;
- ▶ is responsible for ensuring that personal protective clothing is worn by operating personnel, e.g. work clothes, safety shoes and UV safety goggles.

1.6 Intended use

Climate chambers ICH, ICH eco, ICH L and ICH L eco are suitable for stability testing of pharmaceuticals, cosmetics, food etc under long-term stable ambient conditions. Any other use could be dangerous. In case of any doubts, please contact the Memmert customer service.

The appliance is not explosion-proof (does not comply with the German workplace health & safety regulation VBG 24). The appliance may only be loaded with materials and substances which cannot form any toxic or explosive vapours at the set temperature and which cannot explode, burst or ignite.

The appliance may not be used for drying, vaporising and branding paints or similar materials the solvents of which could form an explosive mixture when combined with air. If there is any doubt as to the composition of materials, they must not be loaded into the appliance. Potentially explosive gas-air mixtures must not form, neither in the working chamber nor in the direct vicinity of the appliance.

1.7 Changes and conversions

No unauthorised changes or alterations may be made to the appliance. No parts may be added or inserted which have not been approved by the manufacturer.

Unauthorised changes or alterations result in the CE declaration of conformity losing its validity, and the appliance may no longer be operated.

The manufacturer is not liable for any damage, danger or injuries that result from unauthorised changes or alterations, or from non-observance of the regulations in this manual.

1.8 Behaviour in case of malfunctions and irregularities

The appliance may only be used in a flawless condition. If you as the operator notice irregularities, malfunctions or damage, immediately take the appliance out of service and inform your superior.

i You can find information on eliminating malfunctions from page 39.

1.9 Switching off the appliance in an emergency

Press the main switch at the ControlCOCKPIT (Fig. 2) and disconnect the power plug. This disconnects the appliance from the power supply at all poles.

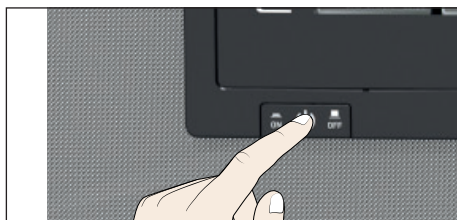

Fig. 2
Switch off the appliance by pressing the main switch

2. Construction and description

2.1 Construction



Fig. 3 Construction

- | | |
|---|---|
| 1 ControlCOCKPIT with capacitive function keys and LCD displays (see page 26) | 7 Inner glass door |
| 2 On/Off switch (see page 23) | 8 Door handle (see page 24) |
| 3 Chamber fan | 9 Illumination box with fluorescent tubes (only for model ICH L / ICH L eco, see page 61) |
| 4 Castors | 10 Turn control with confirmation key |
| 5 Cooling unit (see page 59) | |
| 6 Nameplate (see page 13) | |

2.2 Construction and function

The appliance can heat up the interior to up to 60 °C and cool it down to –10 °C (without humidity and without light) or +10 °C (with humidity). A compressor is used for cooling.

Humidification of the interior is achieved by evaporating water from a tank at a set rate by means of a hot-air generator on the rear side of the appliance. The sterile hot air is introduced into the interior above the fan and mixed with the air current. Humidity is reduced through condensation, using Peltier cooling modules on the rear side of the appliance. Ice that might build up due to dehumidification is automatically defrosted in cycles.

The model ICH L / ICH L eco is equipped with an illumination box in the upper interior, which contains fluorescent tubes. The chamber load can be illuminated with UV light and/or daylight.

2.3 Material

For the outer housing, MEMMERT uses stainless steel (Mat.No. 1.4016 – ASTM 430) and for the interior, stainless steel (Mat.No. 1.4301 – ASTM 304) is used, which stands out through its high stability, optimal hygienic properties and corrosion resistance to many (but not all!) chemical compounds (caution for example with chlorine compounds).

The chamber load for the appliance must be carefully checked for chemical compatibility with the materials mentioned. A material resistance table can be requested from the manufacturer.

2.4 Electrical equipment

- ▶ Operating voltage and current consumption: See nameplate
- ▶ Protection class I, i.e. operating insulation with PE conductor in accordance with EN 61010
- ▶ Protection type IP 20 acc. to EN 60 529
- ▶ Interference suppression acc. to EN 55011 class B
- ▶ Appliance fuse: Safety fuse 250 V/15 A, quick-blow
- ▶ The temperature controller is protected with a miniature fuse 100 mA (160 mA at 115 V)

2.5 Connections and interfaces

2.5.1 Electrical connection

This appliance is intended for operation on an electrical power system with a system impedance Z_{\max} of a maximum of 0.292 ohm at the point of transfer (service line). The operator must ensure that the appliance is operated only on an electrical power system that meets these requirements. If necessary, you can ask your local energy supply company what the system impedance is.

Observe the country-specific regulations when connecting (e.g. in Germany DIN VDE 0100 with residual current circuit breaker).

2.5.2 Communication interfaces

The communication interfaces are intended for appliances which meet the requirements of IEC 60950-1.

USB interface

The appliance is fitted by default with a USB interface in accordance with the USB specification. This way, you can

- ▶ transfer software stored on a USB storage medium to the appliance (see page 55).
- ▶ export protocol logs from the appliance to a USB storage medium (see page 57).
- ▶ transfer user ID data stored on a USB storage medium to the appliance (see page 58).

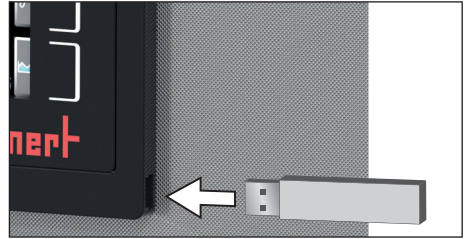

Fig. 4 USB interface

The USB port is located on the right side of the ControlCOCKPIT (Fig. 4).

Ethernet interface

Via Ethernet interface, the appliance can be connected to a network, so that you can transfer programmes created with the AtmoCONTROL software to the appliance and read out protocols. The Ethernet interface is located on the rear of the appliance (Fig. 5).

For identification purposes, each appliance connected must have its own unique IP address. Setting the IP address is described on page 45.

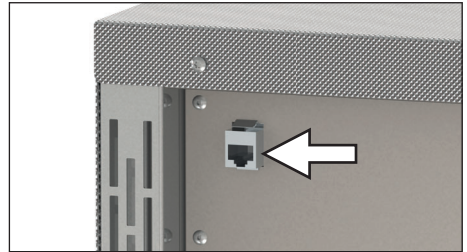

Fig. 5 Ethernet interface



You will find a description of how to transfer programmes via Ethernet in the enclosed AtmoCONTROL manual.

With an optional USB to Ethernet converter, the appliance can be directly connected to a computer / laptop (see Optional accessories on page 16).

2.6 Designation (nameplate)

The nameplate (Fig. 6) provides information about the appliance model, manufacturer and technical data. It is attached to the front of the appliance, on the right behind the door (see page 10).

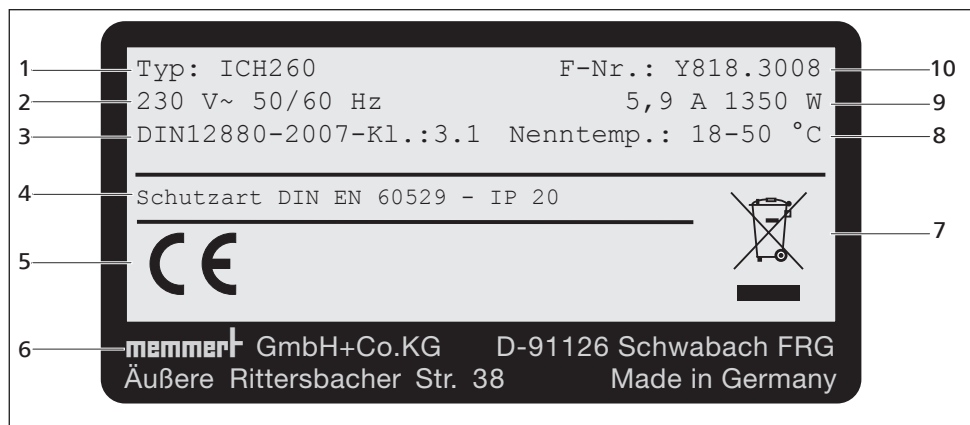

Fig. 6 Nameplate (example)

- | | | | |
|---|---------------------|----|----------------------------|
| 1 | Type designation | 6 | Address of manufacturer |
| 2 | Operating voltage | 7 | Disposal note |
| 3 | Applicable standard | 8 | Temperature range |
| 4 | Protection type | 9 | Connection / power ratings |
| 5 | CE conformity | 10 | Appliance number |

2.7 Technical data

Appliance size		110	260	750
Appliance width D* [mm]		745	824	1224
Appliance height E* [mm]		1233	1552	1950
Appliance depth F* (without door handle) [mm]		585	685	785
Depth of door lock [mm]			56	
Chamber width A* [mm]		560	640	1040
Chamber height B* [mm]		480	800	1200
Chamber depth C* [mm]		400	500	600
Chamber volume [litres]		108	256	749
Weight including packaging [kg]		127	209	324
Power [W]	ICH / ICH eco	1350		
	ICH L / ICH L eco	1450		1550
Current consumption [A]	230 V 50/60 Hz	5.9		
	230 V, 50/60 Hz with light	6.3		6.8
	115 V 50/60 Hz	11.7		
	115 V, 50/60 Hz with light	12.7		13.5
max. number of sliding shelves		5	9	14
max. load per sliding shelf [kg]		20		30
max. load per appliance [kg]		150	200	
Working temperature range (°C)	with humidity	+10 to +60 °C		
	without humidity	-10 to +60 °C		
	with light	0 to +60 °C		
Setting temperature range (°C)		-10 to +60 °C		
Adjustment precision (°C)		0.1		
Adjustment range humidity (% rh)		10 to 80		
Adjustment precision humidity (% rh)		1		
Illumination (only ICH L / ICH L eco)	Standard illuminant	D65/UV		
Refrigerant	ICH / ICH L	R134a		
	ICH eco / ICH L eco	R744		

* see Fig. 7 on page 14.

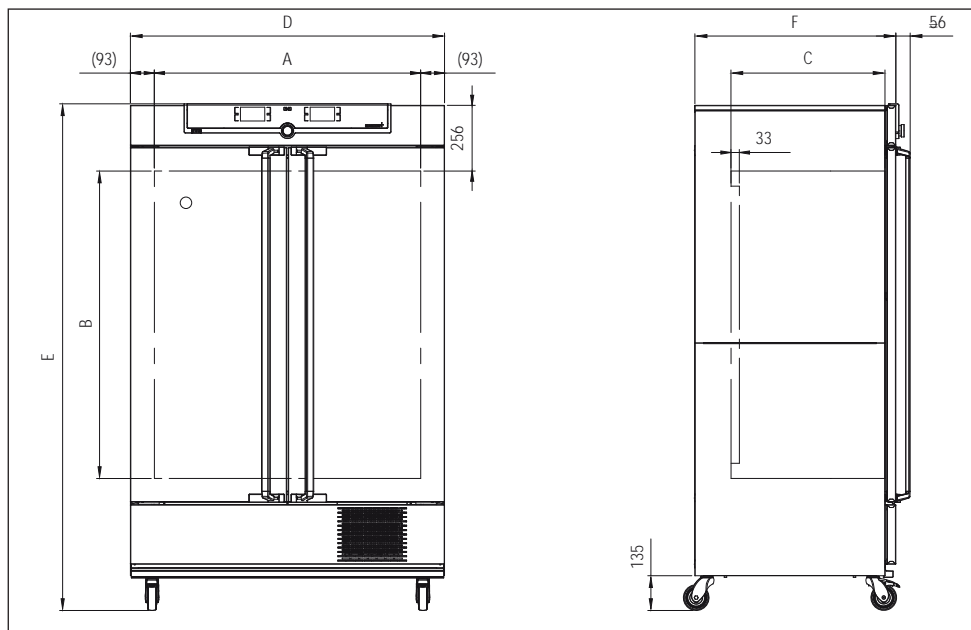

Fig. 7 Dimensions

2.8 Applied directives and standards

Based on the standards and guidelines listed in the following, the products described in this manual have received a CE label from the company Memmert:



- ▶ Directive 2014/30/EU amended (Directive of the council for harmonisation of the laws of the member states on electromagnetic compatibility). Standard complied with: DIN EN 61326-1:2012
- ▶ Directive 2006/42/EC (Directive of the European Parliament and Council dated May 17, 2006 on machinery and amending directive 95/16/EC (revised)). Standard complied with: EN ISO 12100-1:2010

2.9 Declaration of conformity

You can download the EC declaration of conformity of the appliance online:

English: <http://www.memmert.com/en/service/downloads/ce-statement/>

German: <http://www.memmert.com/de/service/downloads/eg-konformitaetserklaerung/>

2.10 Ambient conditions

- ▶ The appliance may only be used in enclosed areas and under the following ambient conditions:

Ambient temperature	15 °C to 28 °C (to 34 °C with limited temperature and humidity range)
Humidity rh	max. 70 %, non-condensing
Overtoltage category	II
Pollution degree	2
Altitude of installation	max. 2,000 m above sea level

- ▶ The appliance may not be used in areas where there is a risk of explosion. The ambient air must not contain any explosive dusts, gases, vapours or gas-air mixtures. The appliance is not explosion-proof.
- ▶ Heavy dust production or aggressive vapours in the vicinity of the appliance could lead to sedimentation in the interior and, as a consequence, could result in short circuits or damage to electrical parts. For this reason, sufficient measures to prevent large clouds of dust or aggressive vapours from developing should be taken.

2.11 Scope of delivery

- ▶ Power cable
- ▶ Sliding grid (load capacity 30 kg each)
- ▶ Water tank with connection hose
- ▶ USB storage medium with software and AtmoCONTROL manual
- ▶ The operating instructions at hand
- ▶ Calibration certificate
- ▶ Separately packaged fastening material for wall mounting (see page 20)
- ▶ Tank holder (only for appliances of size 750, see page 23)

2.12 Optional accessories

- ▶ USB to Ethernet converter (Fig. 8). Makes it possible to connect the Ethernet connection interface (see page 12) to the USB port of a computer / laptop.
- ▶ Reinforced, sliding steel grids with a load capacity of 60 kg each (for appliance size 110 and larger)

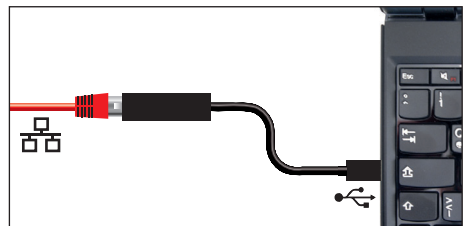

Fig. 8 Converter USB to Ethernet

3. Delivery, transport and setting up

3.1 For your Safety



Warning!

Because of the heavy weight of the appliance, you could injure yourself if you try to lift it. For carrying appliances of size 110, at least 4 people are needed. Appliances larger than that may not be carried but must be transported with a manual pallet jack or forklift truck.

110	260	750



Warning!

You may get your hands or feet squashed when transporting and installing the appliance. Wear protective gloves and safety boots. When grasping the bottom of the appliance, grasp it only on the sides:



Warning!

The appliance could fall over and seriously injure you. Never tilt the appliance and transport it in upright position and without load only (except for standard accessories such as steel grids or shelves). Appliances with castors always have to be moved by two people.

3.2 Delivery

The appliance is packed in cardboard and is delivered on a wooden pallette.

3.3 Transport

The appliance can be transported in three ways:

- ▶ With a forklift truck; move the forks of the truck entirely under the pallet.
- ▶ On a manual pallet jack
- ▶ On its own castors, in case of the corresponding configuration, for which the catch on the (front) castors must be released

3.4 Unpacking

i To avoid damage, do not unpack the appliance until you reach the installation site.

Remove the cardboard packaging by pulling it upwards or carefully cutting along an edge.

3.4.1 Checking for completeness and transport damage

- ▶ Check the delivery note to ensure that the delivery is complete.
- ▶ Check the appliance for damage.

If you notice deviations from the delivery note, damage or irregularities, do not put the appliance into operation but inform the haulage company and the manufacturer.

3.4.2 Removing the transport protection

Remove the transport protection. It is located between the door hinge, door and frame and has to be removed after opening the door.

3.4.3 Disposing of packaging material

Dispose of the packaging material (cardboard, wood, foil) in accordance with the applicable disposal regulations for the respective material in your country.

3.5 Storage after delivery

If the appliance is first to be stored after delivery: Read the storage conditions from page 65.

3.6 Setting up



Warning!

Due to its centre of gravity, the appliance can fall over to the front and injure you or other people. Always attach the appliance to a wall with the tilt protection (see page 20). In case there is not enough space, do not put the appliance into operation and do not open the door. Contact the Memmert service (see page 2).
The appliance may only be installed on the floor.



Warning!

Risk of poisoning due to slow refrigerant leakage. If the filling quantity of CO₂ is greater than the maximum filling quantity (filling quantity 375 g), a CO₂ warning device and ventilation in machine rooms must be provided. ICH eco/ICH L eco refrigeration systems may only be installed in rooms of at least 4 m³.

3.6.1 Preconditions

The installation site must be flat and horizontal and must be able to reliably bear the weight of the appliance (see Technical data on page 14). Do not place the appliance on a flammable surface.

Depending on the model (see nameplate), a 230 V or 115 V power connection must be available at the installation site.

The distance between the wall and the rear of the appliance must be at least 15 cm. The clearance from the ceiling must not be less than 20 cm and the side clearance from walls or nearby appliances must not be less than 5 cm (Fig. 9). Sufficient air circulation in the vicinity of the appliance must be guaranteed at all times. Do not put anything in front of the fan opening of the cooling unit at the appliance front.

For appliances with castors, these need to be positioned in forward direction at all times.

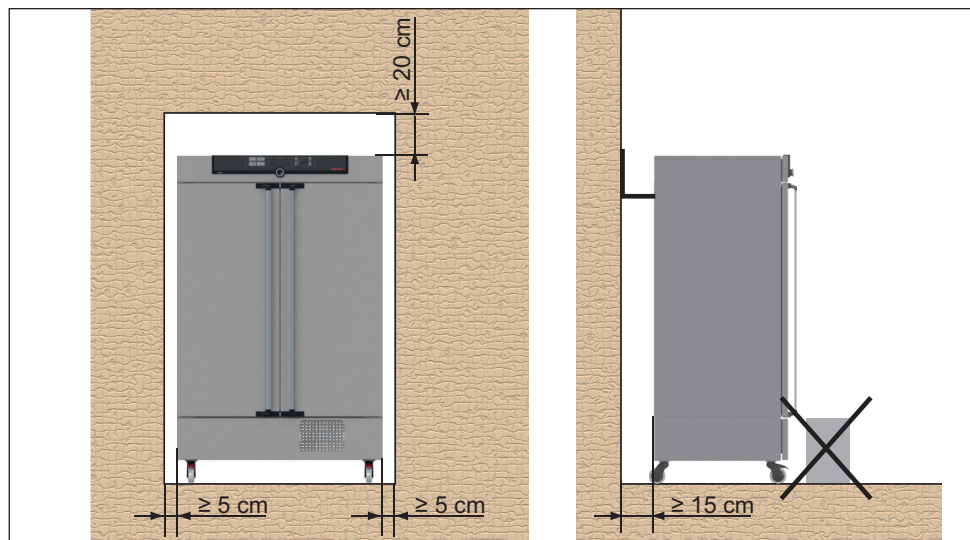
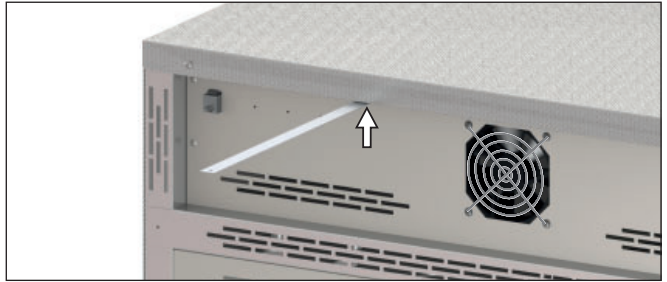

Fig. 9 Minimum clearance from walls and ceiling

3.6.2 Tilt protection

Attach the appliance to a wall with the tilt protection. The tilt protection is included in the delivery.

1. Screw the tilt protection as shown onto the back of the appliance.



2. Bend the tilt protection upwards by 90 ° in the desired distance to the wall (consider the minimum distance to the wall, see Fig. 9).



3. Drill a hole, insert a plug and screw the tilt protection to a suitable wall.

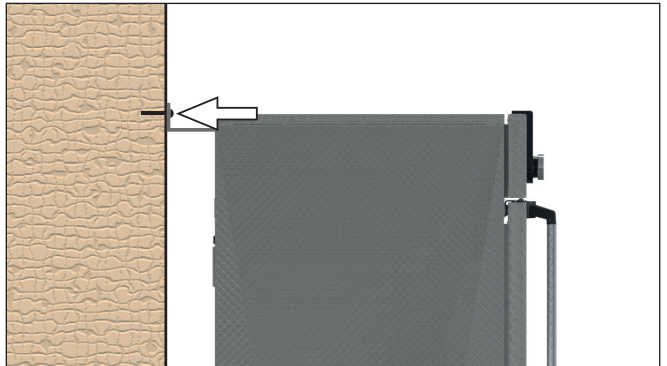

3.6.3 Adjusting the doors

For appliances it is possible to adjust doors that warp due to the floor conditions. In order to do so, every door has two adjuster screws at the top and at the bottom (Fig. 10).

1 First, adjust the door at the top and then, if further adjustment is necessary, at the bottom as well.

1. Open the door.
2. Undo the screws.
3. Adjust the door.
4. Tighten the screws again.
5. Check door alignment.
6. If necessary, readjust.

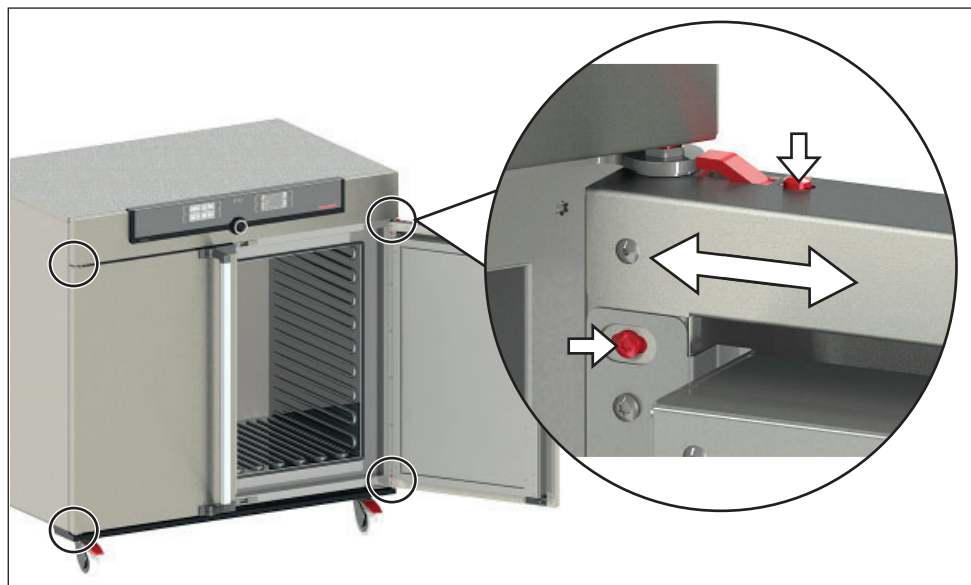

Fig. 10 Door adjustment screws

4. Putting into operation

● Caution:

1 The first time the appliance is operated, it must not be left unattended until it has reached the steady state.

The temperature limiter might have been triggered during transport. Press the red button on the back of the appliance to reset the temperature limiter before putting the appliance into operation.

4.1 Connecting the appliance

● Caution:

1 Observe the country-specific regulations when making connections (e.g. in Germany DIN VDE 0100 with residual current circuit breaker). Observe the connection and power ratings (see nameplate and "Technical Data" on page 14). Make sure to establish a safe PE conductor connection.

Plug the provided power cable into the rear of the appliance and connect it to the power supply (Fig. 11).

Lay the power cable so that

- ▶ it is always accessible and within reach so it can be disconnected quickly in the event of failure or emergencies;
- ▶ no one can trip over it;
- ▶ it does not come into contact with any hot parts.

4.2 Fill up and connect the water tank

Water specifications

Only demineralised/deionised water with the following specifications may be used in Memmert appliances:

- ▶ Conductivity of 5 – 10 $\mu\text{S}/\text{cm}$
- ▶ pH value between 5 and 7
- ▶ chlorine-free

The use of ultrapure water or DI water with an electrical conductance level below 5 $\mu\text{S}/\text{cm}$ can damage silicone tubing and cause pitting on the stainless steel components installed. Unsuitable water also creates favourable conditions for limescale in the steam generators and steam pipes.

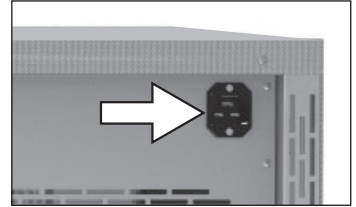

Fig. 11 Connect the power cable to the rear of the appliance

Fill the supplied water tank with water and connect it with the enclosed tube to the "H₂O" connection on the rear of the chamber (Fig. 12).

For appliances of size 750, the tank can be attached to the appliance with the included tank holder (Fig. 13). To do so, hook the tank holder into the slots on the rear of the appliance. For wall mounting, the tank holder also has two drill holes (fastening material not included in the delivery).

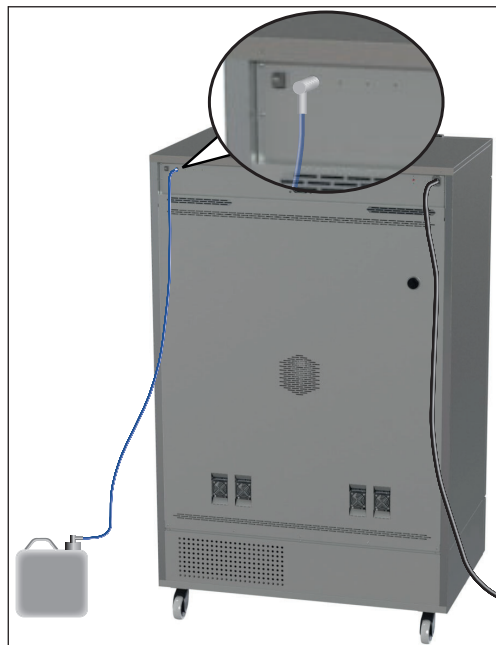



Fig. 12 Water connection



Fig. 13 Tank holder

4.3 Switching on

Switch on the appliance by pressing the On/Off switch on the front of the appliance (Fig. 14).

The starting process is shown by three animated white dots . If the dots have another colour, an error has occurred (see page 42).

- 1 After the first start-up, the appliance display is set to English by default. You can change the language as described from page 44. However, to get a basic overview of operating the appliance, you should read the following chapter first.

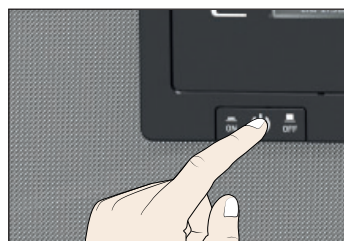

Fig. 14 Switching on the appliance

5. Operation and control



Warning!

UV light is a danger to your eyes. Your eyes could be injured by UV light if you do not wear protection. Always wear UV safety goggles when opening the door of the ICH L / ICH L eco climate chamber. This is indicated by the warning signs on the door (see page 8).



Caution!

When in operation, small amounts of condensed water may leak from the appliance. Always wear shoes with slip-proof soles and wipe up the condensed water immediately.



Caution!

The surfaces in the appliance's interior and the chamber load may be very cold. Always wear gloves when you touch the interior of the appliance.

5.1 Operating personnel

The appliance may only be operated by persons who are of legal age and have been instructed accordingly. Personnel who are to be trained, instructed or who are undergoing general training may only work with the appliance under the continuous supervision of an experienced person.

5.2 Opening the door

- ▶ To open the door, pull the door handle to the side (to the left or to the right, depending on the door variation, see Fig. 15, A) and open the door completely.
- ▶ To close the appliance, push the door closed and the door handle to the side (B).

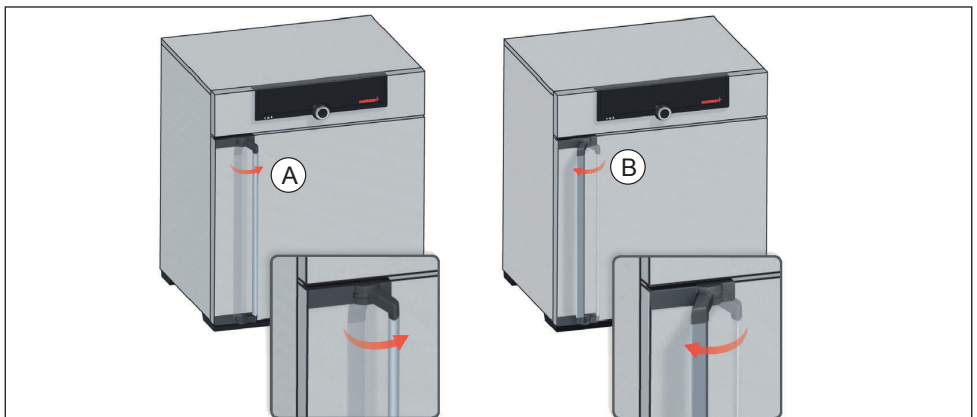

Fig. 15 Opening and closing the door

**Warning!**

If the door is open while the appliance is in operation, the appliance may overheat and pose a fire hazard. Do not leave the door open during operation.

**Warning!**

In case of appliances of a certain size, you can get accidentally locked in, which is life-threatening. Do not climb into the appliance!

5.3 Loading the appliance

**Warning!**

When loading the appliance with an unsuitable load, poisonous or explosive vapours or gases may be produced. This could cause the appliance to explode, and people could be severely injured or poisoned. The appliance may only be loaded with materials which do not form any toxic or explosive vapours when heated up and cannot ignite (see also Intended use on page 9). If there is any doubt as to the composition of materials, they must not be loaded into the appliance.



i Caution:

Check the chamber load for chemical compatibility with the materials of the appliance (see page 11).

Insert the sliding steel grids or sliding shelves. The maximum number of grids / shelves and the load capacity are specified in the technical data overview from page 14.

i To achieve the correct heating capacity, the type of drawer used – Grid or Shelf – must be set in the menu under SETUP (see page 56).

The chamber must not be loaded too tightly, so that proper air circulation in the interior is guaranteed. Do not place any of the chamber load on the floor, touching the side walls or right below the ceiling of the chamber (Fig. 16, see also the "correct loading" sticker on the appliance).

In case of improper loading (chamber loaded too tightly), the set temperature may be exceeded or it may take longer until it is reached.

i The appliance is not suitable for long-term storing at sub-zero temperatures. During permanent operation, the glass door may ice over.

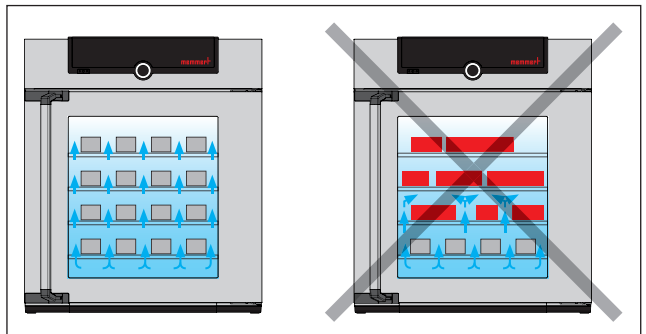

Fig. 16 Correct placement of the chamber load

5.4 Operating the appliance

5.4.1 ControlCOCKPIT

In manual operation, the desired parameters are entered at the ControlCOCKPIT on the front of the appliance (Fig. 17). You can also make basic settings here (menu mode). Additionally, warning messages are displayed, e.g. if the temperature is exceeded. In programme mode, the parameters defined, the programme description, the programme segment currently active and programme duration remaining are displayed (for a more detailed description, see page 32).

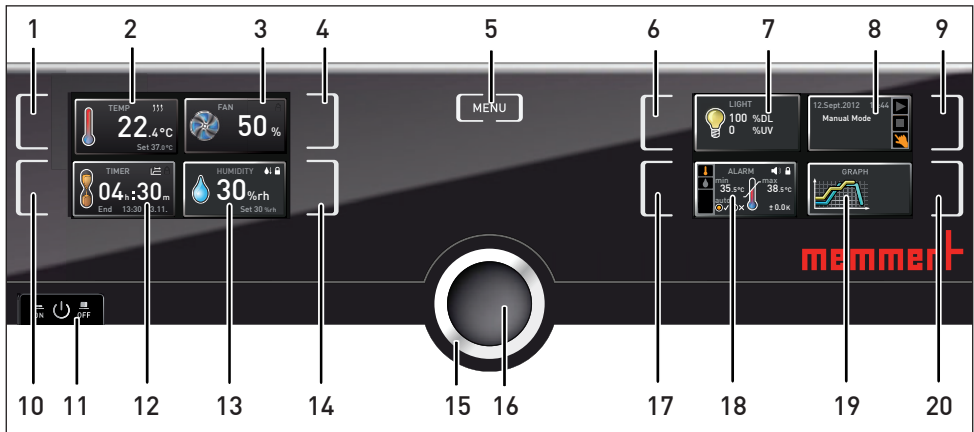

Fig. 17 ControlCOCKPIT in operating mode (width may differ depending on appliance size)

- | | |
|--|--|
| <ol style="list-style-type: none"> 1 Activation key for temperature setpoint adjustment 2 Setpoint and actual temperature display 3 Fan speed display 4 Activation key for fan speed setting 5 Switch to menu mode (see page 43) 6 Interior lighting activation key (only for model ICH L / ICH L eco) 7 Display interior lighting (only for model ICH L / ICH L eco) 8 Appliance state and programme display 9 Activation key for the appliance state 10 Activation key digital backwards counter with target time setting, adjustable from 1 minute to 99 days | <ol style="list-style-type: none"> 11 On/Off switch 12 Display digital backwards counter with target time setting, adjustable from 1 minute to 99 days 13 Humidity control display 14 Humidity control activation key 15 Turn control for setpoint adjustment 16 Confirmation key (accepts setting made with the turn control) 17 Activation key setting the temperature and humidity monitoring 18 Display temperature and humidity monitoring 19 Graphic representation 20 Activation key for graphic representation |
|--|--|

5.4.2 Basic operation

In general, all settings are made according to the following pattern:

1. Activate the desired parameter (e.g. temperature). To do so, press the corresponding activation key on the left or right of the respective display. The activated display is lined in colour, the other displays are dimmed. The set value is highlighted in colour.

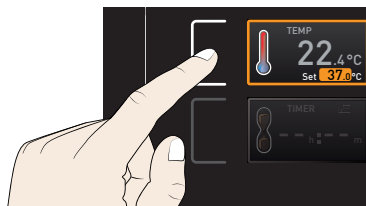

2. By turning the turn control to the left or right, adjust the set value (e.g. to 37.0 °C).

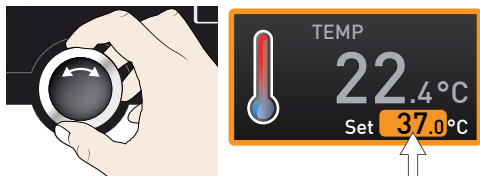

3. Save the set value by pressing the confirmation key. The display returns to normal and the appliance begins adjusting to the defined set value.

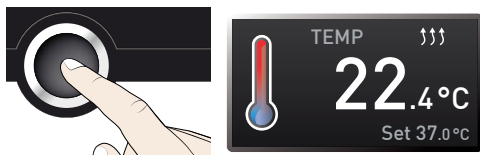

Additional parameters can be set accordingly.

- 1 If no new values are entered or confirmed for approx. 30 seconds, the appliance automatically restores the former values.

If you want to cancel the setting procedure, press the activation key on the left or right of the display that you want to exit. The appliance restores the former values. Only the settings that you have confirmed by pressing the confirmation key before cancelling the setting procedure are accepted.



5.4.3 Operating modes

The appliance can be operated in different modes:

- ▶ **Manual mode:** The appliance runs in permanent operation at the values set on the ControlCOCKPIT. Operation in this mode is described in chapter 5.4.4.
- ▶ **Operation with digital backwards counter with target time setting, adjustable from 1 minute to 99 days (Timer):** The appliance runs at the values set until the timer has elapsed. Operation in this mode is described in chapter .
- ▶ **Programme mode:** The appliance automatically runs programme sequences which have been defined using AtmoCONTROL software at a computer / laptop and then transferred to the appliance from a USB stick or via Ethernet. Operation in this mode is described in chapter 5.5.
- ▶ via remote control

1 The status display shows you which operating mode or operating state the appliance is currently in. The current operating state is highlighted in colour and indicated by the text display:

- Appliance is in programme mode
- Programme is stopped
- Appliance is in manual mode

The example on the right shows the appliance in manual mode, identified by the coloured hand symbol.

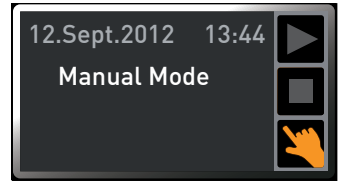

▶ When the appliance is in timer mode, Timer active is displayed:

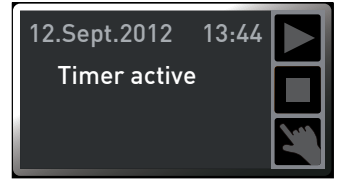

▶ When the appliance is in remote control mode, the symbol appears in the temperature display:

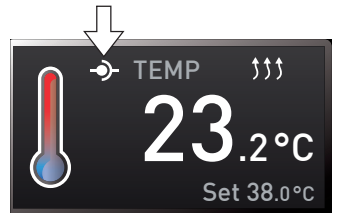

5.4.4 Manual mode

In this operating mode, the appliance runs in permanent operation at the values set on the ControlCOCKPIT.

Adjustment options

As described in chapter 5.4.2, you can set the following parameters after pressing the corresponding activation key (in any sequence):

Temperature

Adjustment range: dependent on model and operating mode (see nameplate and technical data on page 14)

- 1** Heating operation is indicated by the symbol.
- 1** Cooling is indicated by the symbol.

You can select °C or °F as the temperature unit displayed (see page 46).

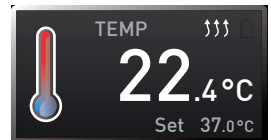

Fan speed

Adjustment option: 10 % to 100 % in steps of 10%

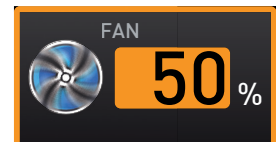

Humidity

Adjustment range: 10 to 80 % rh

- 1** Humidification is indicated by the symbol.
- 1** Dehumidification is indicated by the symbol.



A high level of air humidity in the interior can only be achieved without condensation if the interior is thoroughly heated. For this reason, how fast the humidity is dynamically adjusted to approach the setpoint depends on the interior temperature.

Interior lighting (only ICH L / ICH L eco)

Adjustment range:

Daylight (DL) on (100 %) or off (0 %)

UV light (UV) on (100 %) or off (0 %)

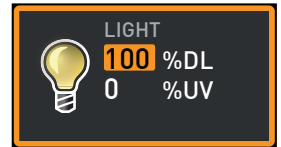

Setting interior lighting

1. Activate light display. To do so, press the activation key on the left side of the light display. The daylight entry DL is selected automatically.

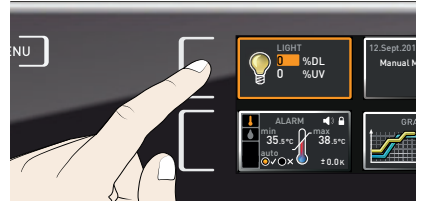

2. By turning the turn control to the left or right, set the desired daylight value (0 % = off, 100 % = on).

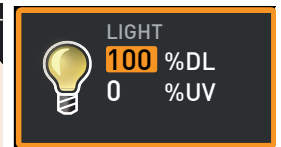

3. Save the setting by pressing the confirmation key. The UV entry (UV light) is automatically activated.

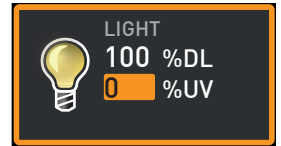
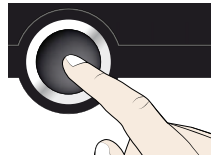

4. By turning the turn control to the left or right, set the desired UV light value (0 % = off, 100 % = on).

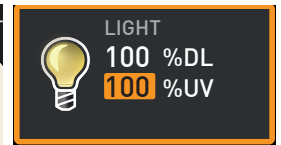

5. Save the setting by pressing the confirmation key.

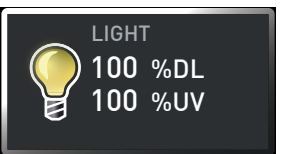
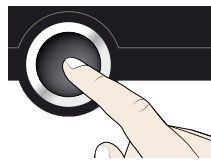

- i** As soon as the illumination boxes are active, the refrigeration unit has to compensate the residual heat produced by the illumination boxes. This means operation is only possible at limited temperature and humidity range. We recommend a temperature of 25 °C and a humidity of 50 % RH at most. Depending on the ambient conditions, there may be some condensation in the chamber.

5.4.5 Operation with digital backwards counter with target time setting, adjustable from 1 minute to 99 days (Timer)

In timer operation, you can adjust the time the appliance runs at the set value. The appliance has to be in manual operating mode for this.

1. Press the activation key to the left of the timer display. The timer display is activated.

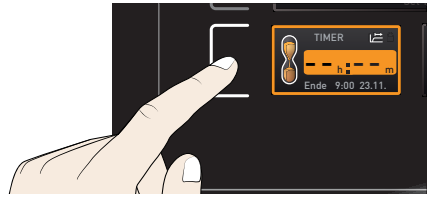

2. Turn the turn control until the desired duration is displayed – in this example 4 hours 30 minutes. The approximate end time is shown beneath, in a smaller font.



- i** Up to a duration of 23 hours 59 minutes, the time is displayed in hh:mm (hours:minutes) format. For 24 hours and more, the format dd:hh (days:hours) is used. The maximum duration adjustable is 99 days 00 hours.

3. Press the confirmation key to confirm.

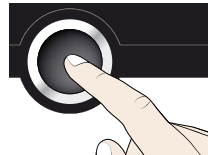

The display now shows the remaining time in a large font and the approximate end time in a smaller font beneath. The status display shows „Timer active“.

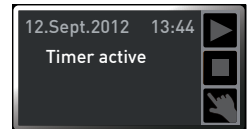
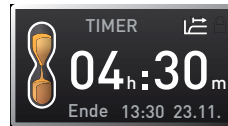

4. Now, as described under 5.4.4, set the individual values for temperature, air flap position etc. which you want the appliance to operate at. The set values can be changed at any time during the timer. The changes are effective immediately.

- i** In Setup, you can choose if the timer should run setpoint-dependent or not. This determines whether the timer should not start until a tolerance band around the set temperature is reached or if it should start right after activation (see page 47). If the timer runs setpoint-dependent, this is indicated by the  symbol in the timer display.

When the timer has elapsed, the display shows 00h:00m. All functions (heating etc.) are switched off. In addition, an acoustic alarm sounds, which can be turned off by pressing the confirmation key.

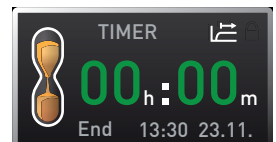

To deactivate the timer, open the timer display by pressing the activation key again and then turning the turn control to reduce the timer setting until --:-- is displayed. Confirm with the confirmation key.

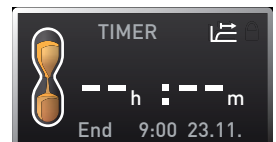

5.4.6 Programme mode

In this operating mode, programmes saved in the appliance can be started with different combinations of individual parameters (temperature, humidity, interior lighting) at staggered

intervals, which the appliance then automatically processes in sequence. These programmes are not created directly at the appliance but externally at a computer / laptop and using AtmoCONTROL software. Transfer to the appliance is possible using the provided USB storage medium or via Ethernet.



A description of how to create and save programmes can be found in the separate AtmoCONTROL software manual.

Starting a programme

1. Press the activation key to the right of the status display. The current operating mode is highlighted automatically, in this example manual mode (👉).

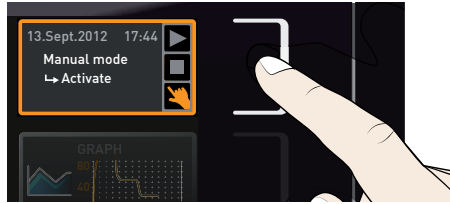

2. Turn the turn control until the ▶ start symbol is highlighted. The current programme is displayed, in this example Test 012.

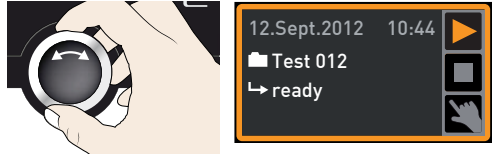

i Only the programme currently selected in the menu and shown in the display can be used. If you want to process another programme, you need to activate it in the menu first (description from page 55).

3. To start the programme, press the confirmation key. The programme starts. The display shows:

- ▶ the programme description (in this example Test 012)
- ▶ the programme segment description, in this example Ramp 1
- ▶ the current run (in case of loops)

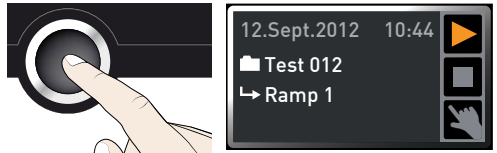

i You cannot change any parameters (e.g. the temperature) at the appliance while a programme is running. However, the displays ALARM and GRAPH can still be used.

Cancelling a programme

You can cancel an active programme at any time.

1. Press the activation key to the right of the status display. The status display is automatically highlighted.



- Turn the turn control until the  stop symbol is highlighted.

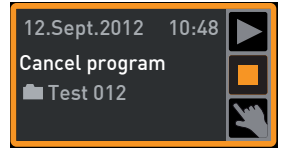

- Press the confirmation key to confirm. The programme is cancelled.

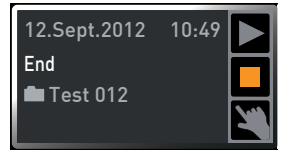
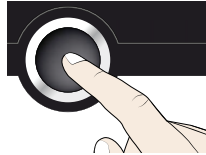

i A cancelled programme cannot be resumed at the point it was cancelled. It must be restarted from the beginning.

End of programme

The display shows End when the programme is finished.

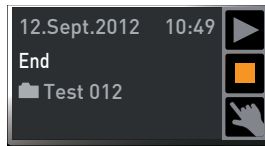

You can now

- ▶ restart the programme as described
- ▶ select another programme for processing in menu mode (see page 55) and run it as described.
- ▶ return to manual mode. To do so, reactivate it by pressing the activation key next to the status display, then turn the turn control until the hand symbol  is highlighted in colour and press the confirmation key.

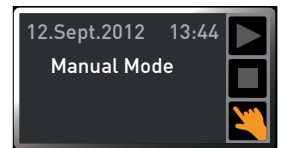

5.5 Monitoring function

5.5.1 Temperature monitoring

The appliance is equipped with a multiple overtemperature protection in accordance with DIN 12 880. This serves to avoid damage to the chamber load and/or appliance in case of a malfunction:

- ▶ electronic temperature monitoring (TWW)
- ▶ automatic temperature monitor (ASF)
- ▶ mechanical temperature limiter (TB)

The monitoring temperature of the electronic temperature monitoring is measured via a separate Pt100 temperature sensor in the interior. Temperature monitoring settings are made via the ALARM display. The settings made apply to all operating modes.

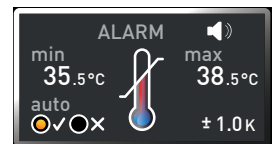

If temperature monitoring has been triggered, this is indicated by the temperature display: the actual temperature is highlighted in red and a  warning symbol is shown (Fig. 18). The type of temperature monitoring triggered (TWW in this example) is shown beneath the temperature.

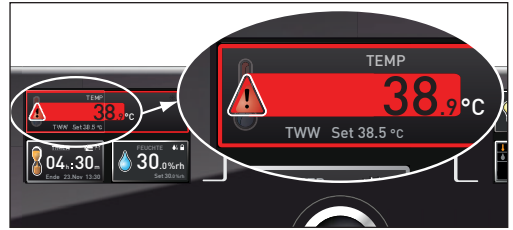



Fig. 18
Temperature monitoring triggered

If the acoustic alarm has been activated in the menu mode (Sound see page 56, indicated by the speaker symbol  in the alarm display), the alarm is additionally signalled by an intermittent acoustic signal, which can be turned off by pressing the confirmation key. Information on what to do in this case is provided in the chapter Malfunctions, warning and error messages from page 39.

Before reading how to adjust temperature monitoring (from page 34), please read the description of the individual monitoring functions here.

Electronic temperature monitoring (TWW)

The manually set monitoring temperature min and max of the overtemperature control is monitored by an adjustable over/undertemperature controller (TWW) protection class 3.3 acc. to DIN 12 880. If the manually set monitoring temperature max is exceeded, the TWW takes over temperature control and begins to regulate the monitoring temperature (Fig. 19).

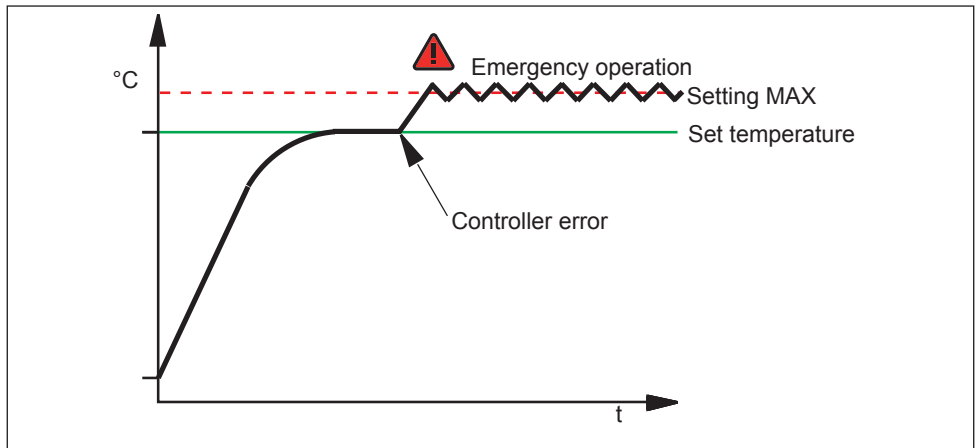

Fig. 19 Schematic diagram of how TWW temperature monitoring works

Automatic temperature monitor (ASF)

ASF is a monitoring device that automatically follows the set temperature setpoint within an adjustable tolerance band (Fig. 20).

The ASF – if switched on – is automatically activated as soon as the actual temperature value reaches 50 % of the set tolerance band of the setpoint (in the example: 50 °C ± 1 K) for the first time (section A).

When the temperature violates the set tolerance band around the setpoint (in the example in Fig. 20:

50 °C ± 2 K) – e.g. if the door is opened during operation (section B of illustration) – the alarm is set off. The ASF alarm is automatically triggered as soon as 50 % of the set tolerance band of the setpoint (in the example: 50 °C ± 1 K) are reached again (section C).

If the temperature setpoint is altered, the ASF is automatically disabled temporarily (in this example: The setpoint is changed from 50 °C to 25 °C, section D) until the tolerance range of the new temperature setpoint is reached again (section E).

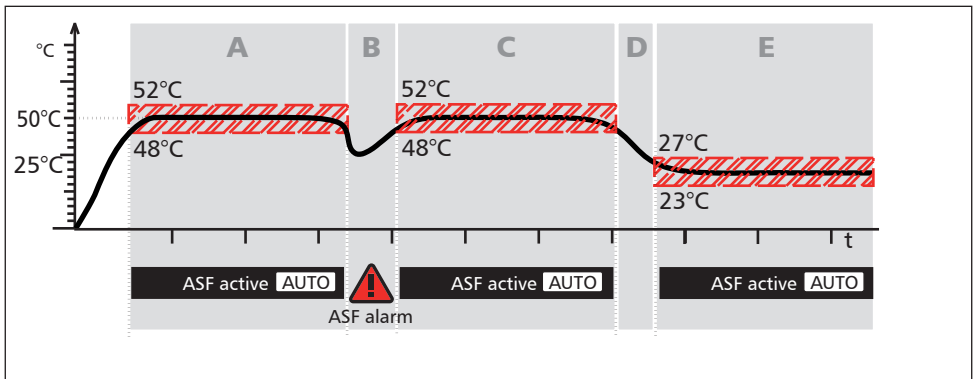

Fig. 20 Schematic diagram of how the ASF temperature monitoring works

Mechanical temperature monitoring: Temperature limiter (TB)

The appliance is equipped with a mechanical temperature limiter (TB) of protection class 1 in accordance with DIN 12 880 (Fig. 21).

If the electronic monitoring unit should fail during operation and the factory-set maximum temperature is exceeded by approx. 20 °C, the temperature limiter, as the final protective measure, switches off the heating permanently.



Fig. 21 Resetting the mechanical temperature limiter

Adjusting temperature monitoring

1. Press the activation key to the left of the ALARM display. The temperature monitoring setting is automatically activated (↓).

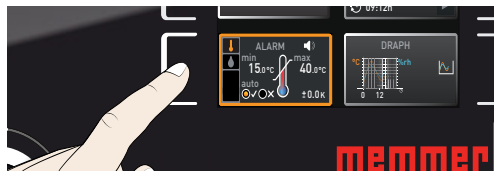

- Save the selection by pressing the confirmation key. The min setting (undertemperature protection) is automatically activated.

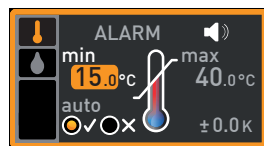
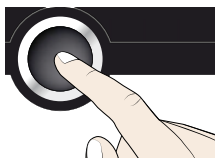

- By turning the turn control, adjust the desired lower alarm limit value, in the example on the right 35.5 °C.

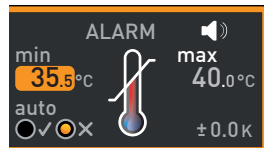

- The lower alarm limit value cannot be set higher than the top one. If no undertemperature protection limit is required, set the lowest temperature.

- Press the confirmation key to confirm. The max display (overtemperature protection) is activated.

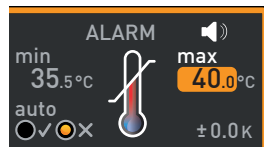
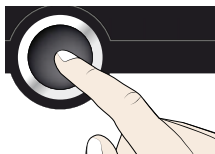

- By turning the turn control, adjust the desired upper alarm limit value, in the example on the right 38.5 °C.

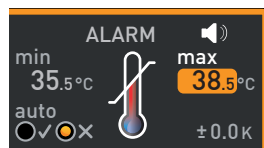

- The monitoring temperature must be set sufficiently high above the maximum set temperature. We recommend 1 to 3 K.

- Accept the upper alarm limit value by pressing the confirmation key. The setting of the automatic temperature monitor (ASF) is automatically activated (auto).

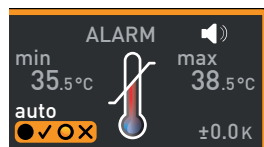
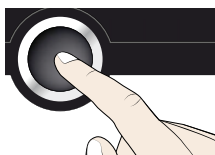

- With the turn control, select ON (✓) or OFF (×).

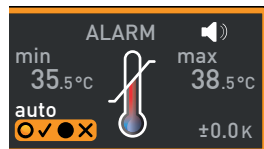

- Press the confirmation key to confirm. The ASF tolerance band setting is activated.

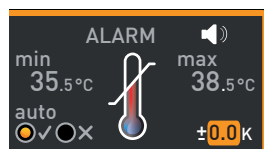
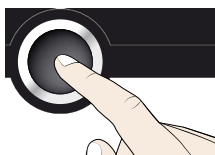

- With the turn control, adjust the desired tolerance band, e.g. 2.0 K.

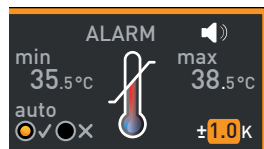

- We recommend a tolerance band of 1 to 3 K.

- Press the confirmation key to confirm. Temperature monitoring is now active.

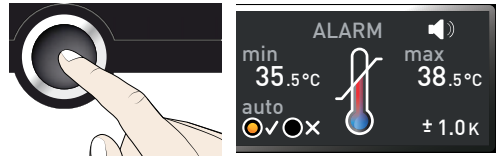

5.5.2 Humidity monitoring

If humidity monitoring has been triggered, this is indicated by the humidity display: the actual humidity is highlighted in red and a warning symbol is shown (Fig. 22). If the acoustic alarm has been activated in the Sound menu (see page 56), which is indicated by the speaker symbol , the alarm is additionally signalled by an intermittent acoustic signal. Information on what to do in this case are provided in the chapter Malfunctions, warning and error messages on page 39.



Fig. 22
Humidity monitoring triggered

Adjusting humidity monitoring

- Press the activation key to the left of the ALARM display. The temperature monitoring setting is automatically activated.

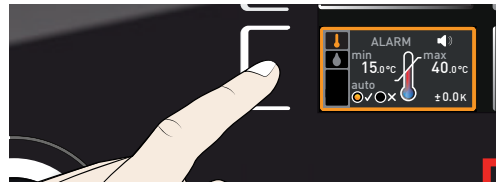

- Turn the turn control until the humidity monitoring entry is highlighted.



- Accept the selection by pressing the confirmation key. The lower humidity alarm limit is automatically highlighted.

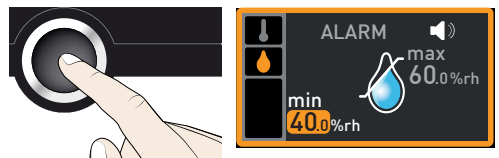

- By turning the turn control, adjust the desired lower alarm limit, in the example on the right 50 % rh.



5. Accept the selection by pressing the confirmation key. The upper humidity alarm limit is automatically highlighted.

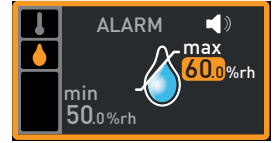
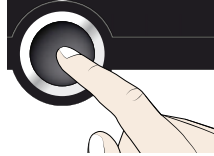

6. By turning the turn control, adjust the desired upper alarm limit, in the example on the right 70 % rh.

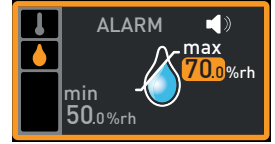

7. Accept the selection by pressing the confirmation key and leave the Alarm display by pressing the activation key on the side. Humidity monitoring is now active.

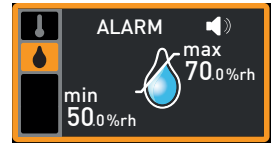
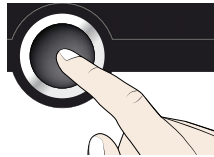

5.6 Graph

The GRAPH display provides an overview of the chronological sequence of the set values and the actual values as a curve.

5.6.1 Temperature profile

1. Press the activation key to the right of the GRAPH display. The display is enlarged and the temperature profile shown.

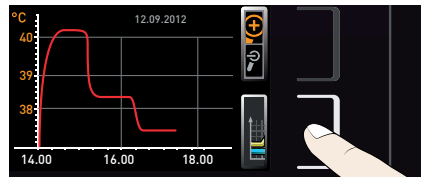

- ▶ To change the time frame to be displayed: Press the activation key next to the $\triangleleft \triangleright$ arrow symbols. The time frame to be displayed can now be changed by turning the turn control.

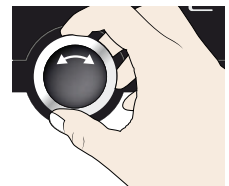
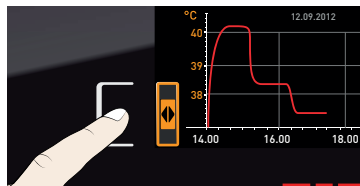

- ▶ To zoom the graph in or out: Press the activation key next to the magnifying glass symbol. Select whether you want to zoom in or out (+/-) with the turn control and confirm your selection by pressing the confirmation key.

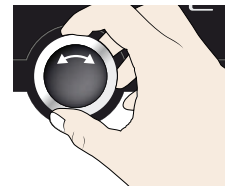

To close the graphical representation, again press the activation key which you have used to activate it.

5.6.2 Humidity profile

1. Activate graphic representation as described above and then press the activation key next to the parameter selection.

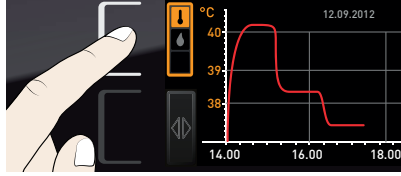

2. Select humidity  with the turn control.

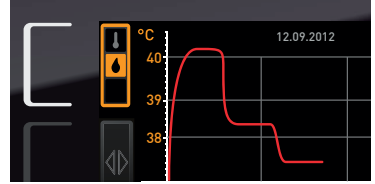
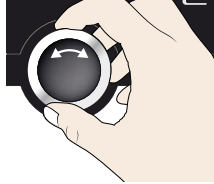

3. Press the confirmation key to confirm. The humidity profile is displayed. You can change the display range as described above, as well as extend or reduce it.

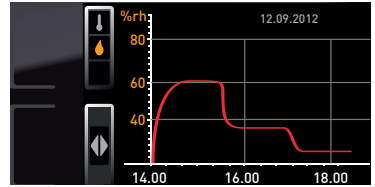
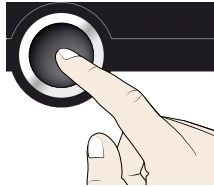

5.7 Ending operation

1. Switch off active appliance functions (turn back the set values).
2. Remove the chamber load.
3. Check the freshwater tank and fill up if necessary (see page 22).
4. Switch off appliance (Fig. 23).

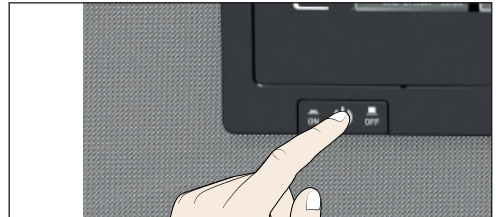

Fig. 23 Switching off the appliance.

6. Malfunctions, warning and error messages



Warning!

After removing covers, live parts may be exposed. You may receive an electric shock if you touch these parts. Malfunctions requiring work inside the appliance may only be rectified by electricians. Observe the separate service manual for this.

Do not try to rectify appliance errors yourself but contact the MEMMERT customer service department (see page 2) or an authorised service point. In case of enquiries, please always specify the model and appliance number on the nameplate (see page 13).

6.1 Warning messages of the monitoring function

- 1 If the acoustic alarm has been activated in the menu mode (Sound, see page 56, indicated by the speaker symbol ), the alarm is additionally signalled by an intermittent acoustic signal. If the confirmation key is pressed, the acoustic alarm can be temporarily switched off until the next alarm event occurs.

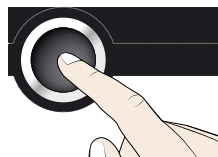

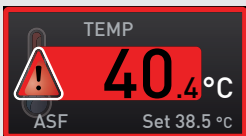
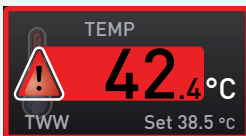

6.1.1 Temperature monitoring

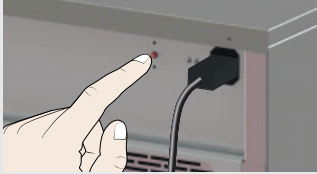

Description	Cause	Action	See
Temperature alarm and "ASF" are displayed 	Automatic temperature monitor (ASF) triggered	Check if the door is closed. Close the door. Extend the ASF tolerance band If the alarm continues: Contact customer service	page 57 page 2
Temperature alarm and "TWW" are displayed 	The adjustable temperature controller (TWW) has assumed heating control.	Increase the difference between the monitoring and setpoint temperature – by either increasing the max value of the temperature monitoring or decreasing the setpoint temperature. If the alarm continues: Contact customer service	page 58 page 2



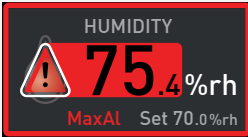
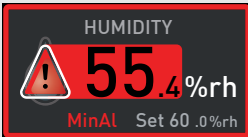

Description	Cause	Action	See
Appliance does not heat up any more	The mechanical temperature limiter (TB) permanently switched off heating.	<ol style="list-style-type: none"> 1. Wait until the appliance cools down. 2. Reset the TB. To do so, press the red button on the right of the appliance rear side until a clicking sound can be heard: 	page 2
Device no longer cools or cools less	Cooling unit fins dirty	Clean the blades with a brush or vacuum cleaner	

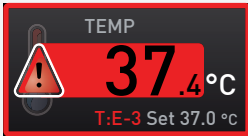
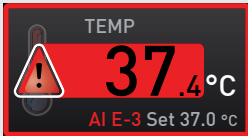
6.1.2 Humidity monitoring

Description	Cause	Action	See
Error display symbol  	Water tank empty	Fill the water tank with water and press the confirmation key.	page 22
Alarm display (MaxAl) 	Upper humidity limit exceeded	Open the door for 30 sec. and wait to see if the appliance reliably adjusts to the setpoint. If the error occurs again, contact customer service.	page 2
Alarm display (MinAl) 	Humidity below lower limit	Check if the door is closed. Check the water supply and the filling level of the water tank. If required, refill the water tank. If the error occurs again, contact customer service.	page 22 page 2

6.2 Malfunctions, operating problems and appliance errors

Error description	Cause of errors	Rectifying errors	See
Displays are dark	External power supply was interrupted	Check the power supply	page 22
	Miniature fuse, appliance fuse or power module faulty	Contact customer service	page 2
Displays cannot be activated	Appliance locked by USER ID	Unlock with USER ID	page 58
	The appliance is in programme, timer or remote control mode (mode "Write" or "Write + Alarm")	Wait until the end of the programme or timer mode or switch off the remote control	
Displays suddenly look different	Appliance is in "wrong" mode	Change to operating or menu mode by pressing the MENU key	
Display T:E-3 in the temperature display 	Temperature operating sensor defective. The monitoring sensor takes over the measurement function.	<ul style="list-style-type: none"> ▶ The appliance can be temporarily operated ▶ Contact customer service as soon as possible 	page 2
Error message AI E-3 in the temperature display 	Temperature monitoring sensor defective. The operating sensor takes over the measurement function.	<ul style="list-style-type: none"> ▶ The appliance can temporarily be kept in service ▶ Contact customer service as soon as possible 	page 2
Error message E-3 in the temperature display 	Operating and monitoring sensor defective	<ul style="list-style-type: none"> ▶ Switch off appliance. ▶ Remove the chamber load ▶ Contact customer service 	page 2

Error description	Cause of errors	Rectifying errors	See
Error message E-6 in the humidity display 	Humidity sensor defective	<ul style="list-style-type: none"> ▶ No humidity control possible ▶ Contact customer service 	page 2
When switching on the appliance, the start animation is displayed in another colour than white 	<ul style="list-style-type: none"> ▶ Cyan : Not enough storage space on the SD card ▶ Red : The system files could not be loaded ▶ Orange : The fonts and images could not be loaded 	<ul style="list-style-type: none"> Contact customer service Contact customer service Contact customer service 	page 2 page 2 page 2

6.3 Power failure

In case of a power failure, the appliance operates as follows:

In manual mode

After power supply has been restored, operation is continued with the parameters set. The time and duration of the power failure are documented in the log memory.

In timer or programme mode

In case of an interruption of the power supply of less than 60 minutes, the current programme is continued from the point at which it was interrupted. For longer interruptions of the power supply, all appliance functions (heating, fan etc.) are switched off.

In remote control mode:

The previous values are restored. If a programme has been initiated via remote control, it is continued.

7. Menu mode

In menu mode, you can make basic settings, load programmes and export protocols, as well as adjust appliance parameters.

Caution:

Before changing menu settings, read the description of the respective functions on the following pages to avoid possible damage to the appliance and/or chamber load.

To enter menu mode, press the MENU key.

To exit the menu mode at any time, press the MENU key again. The appliance then returns to manual mode. Only changes accepted by pressing the confirmation key are saved.

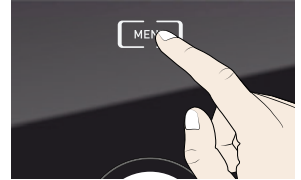

7.1 Overview

Press the MENU key to change between the displays in menu mode:

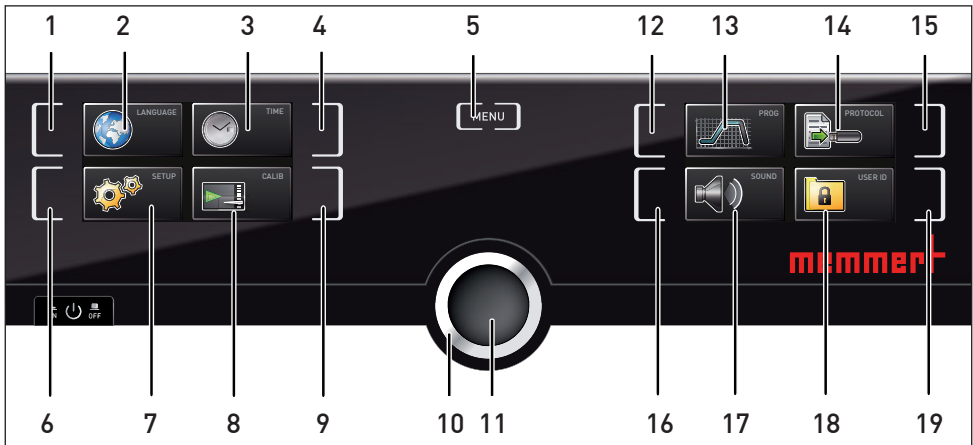

Fig. 24 ControlCOCKPIT in menu mode

- | | |
|---|--|
| <ul style="list-style-type: none"> 1 Language selection activation key 2 Language selection display 3 Date and time display 4 Date and time setting activation key 5 Exit menu mode and return to operating mode 6 Setup activation key (basic appliance settings) 7 Setup display (basic appliance settings) 8 Adjustment display 9 Adjustment activation key 10 Turn control for adjustment | <ul style="list-style-type: none"> 11 Confirmation key (accepts setting made with the turn control) 12 Programme setup activation key 13 Programme setup display 14 Protocol display 15 Protocol activation key 16 Acoustic signal adjustment activation key 17 Acoustic signal adjustment display 18 User ID display 19 User ID activation key |
|---|--|

7.2 Basic operation in menu mode using the example of language selection

In general, all settings in menu mode are done just like in manual mode: Activate the respective display, use the turn control for setting and press the confirmation key to accept the change. A more detailed description is provided in the following, using the example of language selection.

1. Activate the desired parameter (in this example the language). To do so, press the corresponding activation key on the left or right of the respective display. The activated display is enlarged.

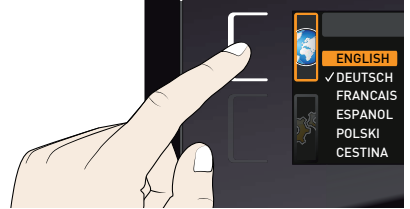

- 1 **i** If you want to exit or cancel your settings, again press the activation key which you have used to activate the display. The appliance returns to the menu overview. Only the settings that you have confirmed by pressing the confirmation key before cancelling the setting procedure are accepted.



2. With the turn control, select the desired new setting, e.g. Español (Spanish).

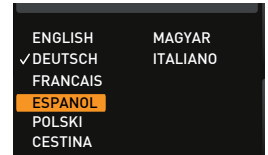

3. Save the setting by pressing the confirmation key.

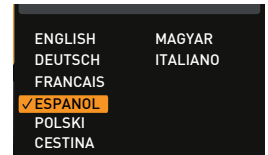
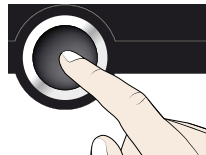

4. To return to the menu overview, press the activation key again.



You can now

- ▶ activate another menu function by pressing the corresponding activation key or
- ▶ return to manual mode by pressing the MENU key.

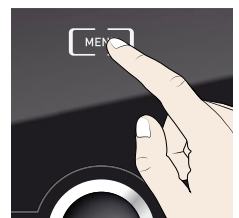

All other settings can be made accordingly. The settings possible are described in the following sections.

1 If no new values are entered or confirmed for approx. 30 seconds, the appliance automatically returns to the main menu and restores the former values.

7.3 Setup

7.3.1 Overview

In the SETUP menu, you can set the following parameters:

- ▶ the IP address and Subnet mask of the appliance's Ethernet interface (for connection to a network)
- ▶ the Unit of the temperature display (°C or °F, see page 46)
- ▶ how the digital backwards counter with target time setting works (Timer mode, see page 47)
- ▶ the type of the slide-in unit (grid or shelf, see page 47)
- ▶ the defrosting system (Defrost, see page 47)
- ▶ Remote control (see page 49)
- ▶ Gateway (see page 49)

1 If the Setup menu contains more entries than can be displayed, this is indicated by the display "1/2". This means that there is a second "page" of entries.

To display the hidden entries, use the turn control to scroll beyond the lowest entry. The page display changes to "2/2".

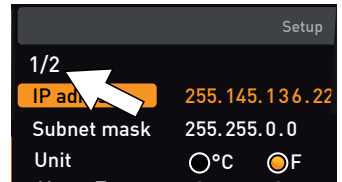

7.3.2 IP address and subnet mask

If you want to operate one or more appliances in a network, each appliance must have its own unique IP address for identification. By default, each appliance is delivered with the IP address 192.168.100.100.

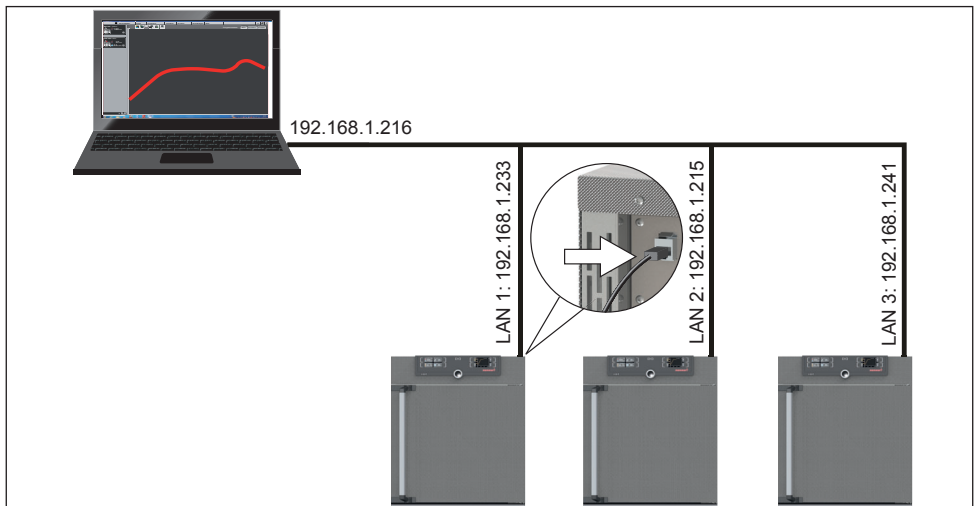
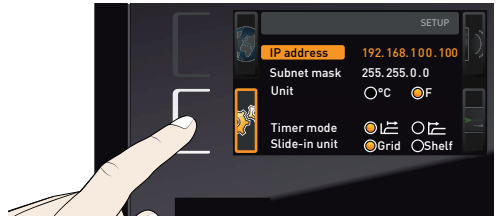
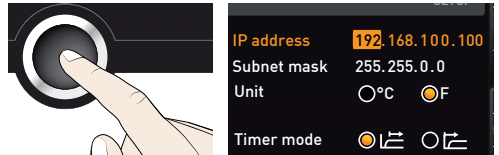

Fig. 25 Operation of several appliances in a network (schematic example)

1. Activate the SETUP display. The entry IP address is automatically highlighted.



2. Accept the selection by pressing the confirmation key. The first three digits of the IP address are automatically selected.



3. With the turn control, set the new number, e.g. 255.

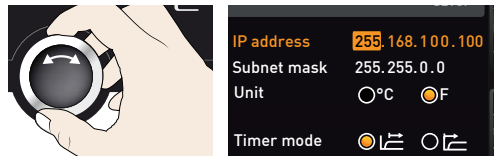

4. Accept the selection by pressing the confirmation key. The next three digits of the IP address are automatically selected. Setting these is done according to the description above.



5. After setting the last three digits, accept the new IP address by pressing the confirmation key. The selection returns to the overview. The subnet mask is set accordingly.

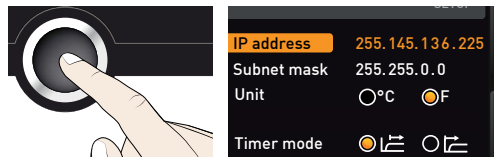

7.3.3 Unit

Here, you can choose whether the temperature is displayed in °C or °F.

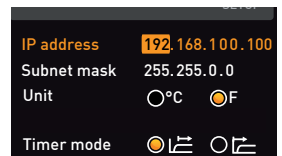

7.3.4 Timer mode

Here, you can choose whether the digital backwards counter with target time setting (see page 29) should run setpoint-dependent or not. This determines whether the timer should not start until a tolerance band of ± 3 K around the set temperature is reached (Fig. 26, B) or if it should start right after activation (A).

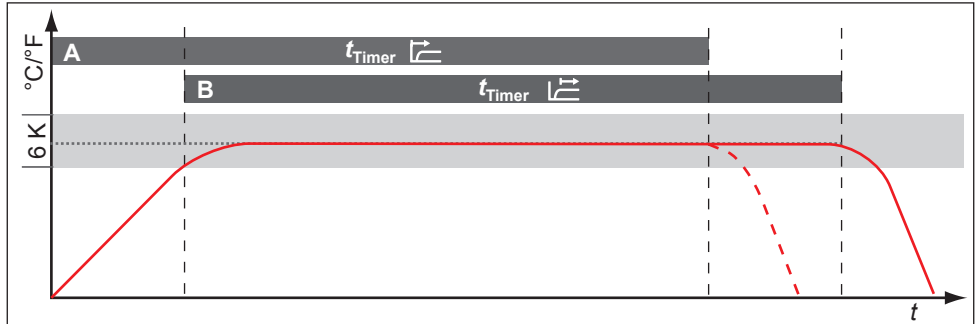
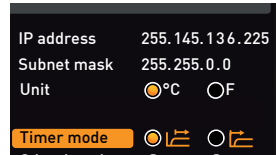
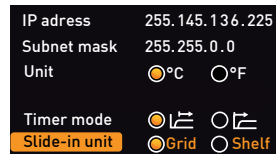

Fig. 26 Timer Mode

- A Timer independent of setpoint: Timer starts right after activation
- B Timer setpoint-dependent: Timer does not start until tolerance band is reached

7.3.5 Type of the slide-in unit (Grid or Shelf)

Here, you have to set the type of the slide-in unit (grid or shelf) used. The selection Shelf enables you to adjust the control function to the different air flow characteristics in the interior when using optional sliding shelves instead of the grids that are part of the standard delivery.



7.3.6 Automatic defrosting system (Defrost)

The integrated automatic defrosting system for the cooling unit ensures perfect operation of the appliance at low temperatures and in permanent operation. The defrosting interval can be set in steps of 6 hours, between 6 and 48 hours. The setting Off deactivates automatic defrosting.

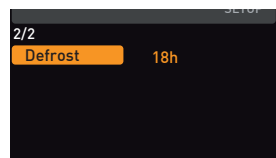

Due to long-term operation with a working temperature below $+15$ °C or due to a damp chamber load and/or the door opening frequently, ice can form in the interior over time. Heavy icing may impair the function of the appliance and could damage the cooling system. In this case, the working chamber should be defrosted. This can be achieved by short heating of the appliance (to 30-40 °C) or by switching it off for a longer period of time, e.g. over night. The resulting melting water can best be collected with a cloth at the front edge of the working chamber. Afterwards, the smooth surface of the interior can easily be cleaned.

Due to this automatic defrosting, there is a minor brief increase in the chamber temperature at regular intervals. If you would like to further reduce this impairment in performance, you can shorten the defrosting frequency, e.g. to every 24 hours.

In this case, please observe if there is a permanent drop in the cooling performance or a strong fluctuation of the actual value, which may be an indication that the cooling unit is icing over. If this is the case, please set the automatic defrosting system one level higher.

If humidity/room temperature are particularly high, it is possible that the factory setting for defrosting, 12 hours, is not sufficient. If this is the case, you should set a more frequent defrosting interval, e.g. every 6 hours.

Automatic defrosting is disabled with the setting Off. When operating at low temperatures, this over time causes the cooling unit to ice over. Regular defrosting needs to be carried out in order to prevent damage to the cooling system.

7.3.7 Dehumidification interval

The dehumidification peltier modules behind the rear panel precisely generate cold spots inside the chamber in order to remove humidity from the appliance in a controlled way.

If the device is dehumidifying for a long period of time in the lower end of the climate diagram, the water in the air will freeze at the dehumidification peltier modules. If solid ice should form at the rear panel around the dehumidification peltier modules, the dehumidification interval must be adjusted.

The dehumidification interval function allows the time spans at which the dehumidification peltier modules cool at maximum capacity to be adjusted individually. The preset value of 35 minutes is recommended for basic applications.

Adjustment range:

- ▶ Min. 15 minutes
- ▶ Max. 180 minutes

Example:

1. Interval begins – dehumidification peltier modules cool at full power and generate coldest point (-12°C), depending on the set time interval.
2. Interval duration expired – dehumidification peltier modules are not operated for a short time, resulting in a local rise in temperature. The ice thaws and the melt water is channelled out.
3. Interval begins again.

The ideal setting for the dehumidification interval is when there is hardly any ice formation on the rear panel and the setpoint humidity value is reached.

- ▶ The interval should be decreased if there is heavy ice formation on the rear panel.
 - ▶ If the setpoint value (humidity) is not reached, the interval should be increased.
- 1 If you change the dehumidification interval, test whether this has a positive effect on ice formation in the interior.

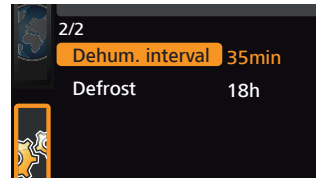

7.3.8 Remote control

In the setup entry Remote control, you can set whether the appliance should be controlled via remote control and if so, in which mode. These settings are available:

- ▶ Off
- ▶ Read Only
- ▶ Write + Read
- ▶ Write + Alarm

When the appliance is in remote control mode, the  symbol appears in the temperature display. In the settings Write + Read and Write + Alarm, the appliance cannot be controlled at the ControlCOCKPIT until the remote control has been switched off (setting Off) or set to Read Only.

1 In order to use the remote control function, programming skills and special libraries are required.

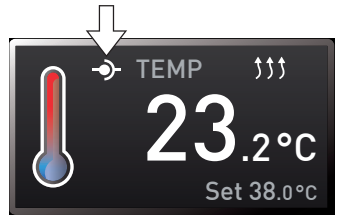
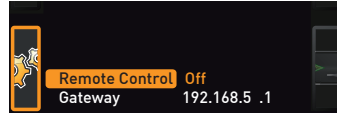

7.3.9 Gateway

The setup entry Gateway is used to connect two networks with different protocols.

The gateway is set the same way as the IP address (see page 45).

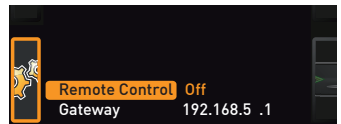

7.4 Date and Time

In the Time display, you can set date and time, time zone and daylight saving time. Changes can only be made in manual operating mode.

1 Always set the time zone (and summer time yes/no) before you set the date and time.

1 Avoid changing the set time after that since this can lead to gaps or overlapping when recording measured values. If you still need to change the time, you should not run a programme immediately before or after doing so.

1. Activate the time setting. To do so, press the activation key on the right side of the Time display. The display is enlarged and the first adjustment option (Date) automatically highlighted.

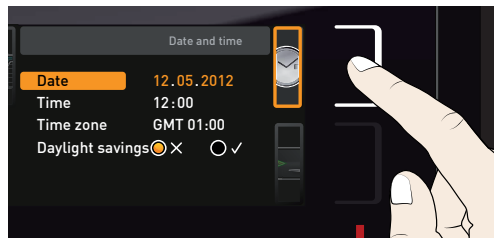

2. Turn the turn control until Time zone is highlighted.

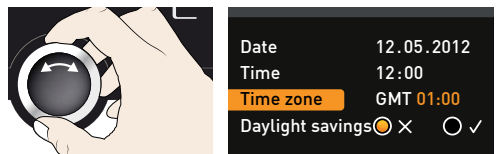

3. Accept the selection by pressing the confirmation key.

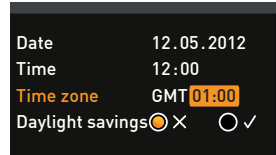
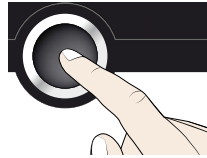

4. Set the time zone of the installation site with the turn control, e.g. 00:00 for Great Britain, 01:00 for France, Spain or Germany. Accept the selection by pressing the confirmation key.

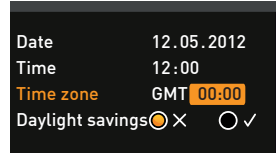

5. With the turn control, select the Daylight savings entry

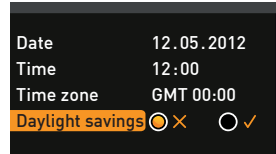

6. Accept the selection by pressing the confirmation key. The adjustment options are highlighted.

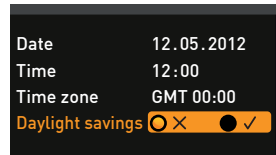
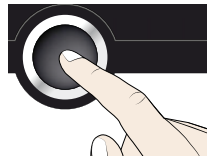

7. Set daylight savings to off (X) or on (checkmark) with the turn control – in this case on (checkmark). Save the setting by pressing the confirmation key.

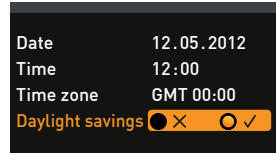
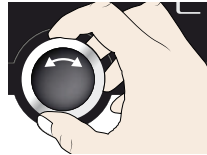

i Daylight saving time and standard time are not changed automatically. For this reason, please keep in mind to adjust them at the beginning of each period.

8. Now, set date (day, month year) and time (hours, minutes) in the same way. Accept the selection by pressing the confirmation key.

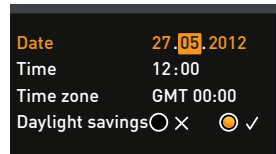

7.5 Calibration

To guarantee perfect control, we recommend to calibrate the appliance once a year.

7.5.1 Temperature adjustment

The appliances are temperature calibrated and adjusted at the factory. In case readjustment should be necessary later on – for example due to influence of the chamber load – the appliance can be calibrated customer-specifically using three calibration temperatures of your choice:

- ▶ Cal1 Temperature calibration at low temperature
- ▶ Cal2 Temperature calibration at medium temperature
- ▶ Cal3 Temperature calibration at high temperature

i For temperature adjustment, you will need a calibrated reference measuring device.

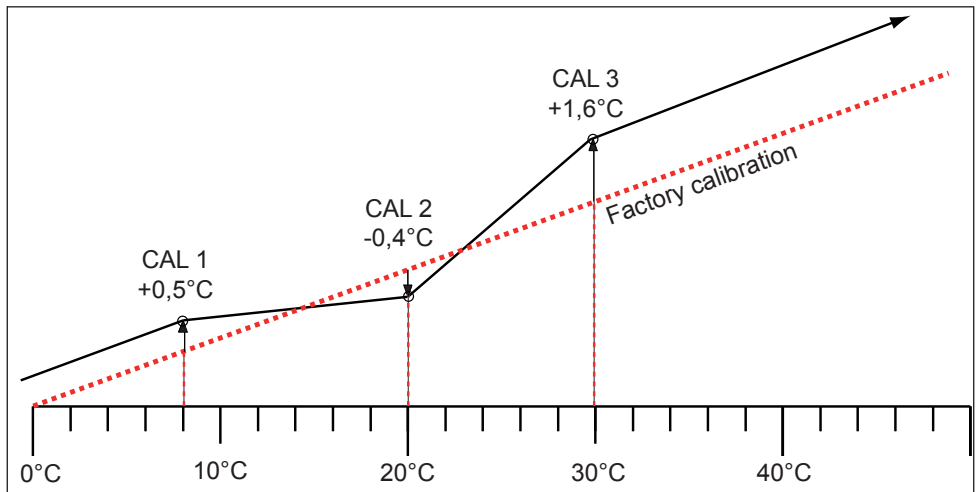
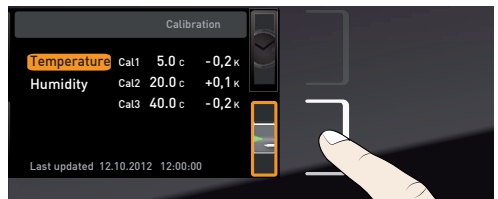

Fig. 27 Schematic example of temperature adjustment

Example: Temperature deviation at 30 °C should be corrected.

1. Press the activation key to the right of the CALIB display. The display is enlarged and the temperature adjustment option is automatically highlighted.



2. Press the confirmation key repeatedly, until the calibration temperature Cal2 is selected.

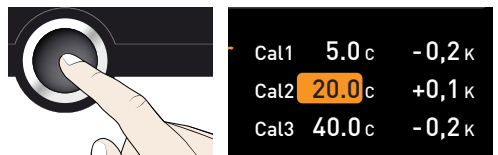

3. With the turn control, set the calibration temperature Cal2 to 30 °C.



Cal1	5.0 c	-0,2 K
Cal2	30.0 c	+0,1 K
Cal3	40.0 c	-0,2 K

4. Save the setting by pressing the confirmation key. The corresponding calibration value is automatically highlighted.

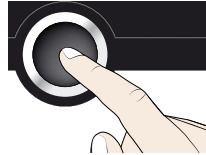

Cal1	5.0 c	-0,2 K
Cal2	30.0 c	+0,1 K
Cal3	40.0 c	-0,2 K

5. Set the calibration value to 0.0 K and accept the setting by pressing the confirmation key.



Cal1	5.0 c	-0,2 K
Cal2	30.0 c	0,0 K
Cal3	40.0 c	-0,2 K

6. Position the sensor of a calibrated reference instrument centrally in the appliance's working chamber.
7. Close the door and, in manual mode, adjust the set temperature to 30 °C.

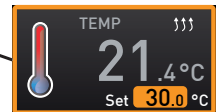
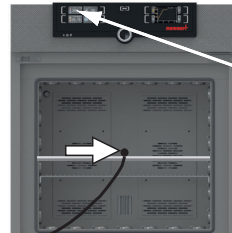

8. Wait until the appliance reaches the set temperature and displays 30 °C. The reference instrument should display 31.6 °C.

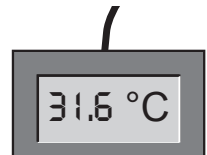
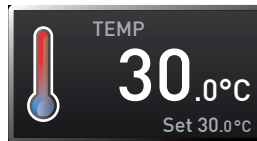

9. In the SETUP, adjust the calibration value Cal2 to +1.6 K (actual value measured minus setpoint temperature) and save the setting by pressing the confirmation key.



Cal1	5.0 c	-0,2 K
Cal2	30.0 c	+1,6 K
Cal3	40.0 c	-0,2 K

10. After the calibration procedure, the temperature measured by the reference instrument should now also be 30 °C.

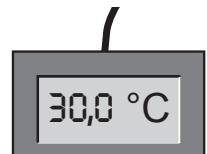
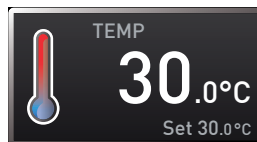

With Cal1, a calibration temperature below Cal2 can be programmed accordingly, and with Cal3, a temperature above. The minimum difference between the Cal values is 10 K.

i If all calibration values are set to 0.0 K, the factory calibration settings are restored.

7.5.2 Humidity calibration

Humidity control can be adjusted according to customer requirements by means of three freely selectable balance points. For each selected calibration point, a positive or negative compensation correction value between -10 % and +10 % can be set (Fig. 28).

i For humidity adjustment, you will need a calibrated reference measuring device.

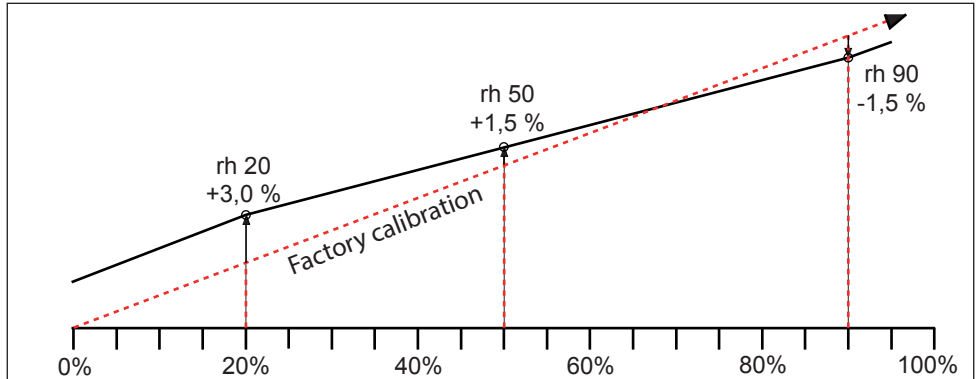
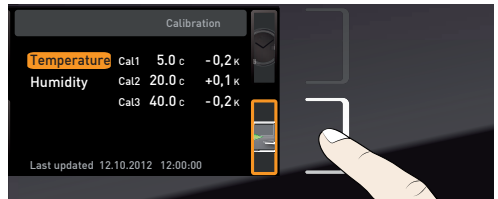

Fig. 28 Humidity adjustment (example)

Example: Humidity deviation at 60 % should be corrected.

1. Press the activation key to the right of the CALIB display. The display is enlarged and the temperature adjustment option is automatically highlighted.



2. Turn the turn control until Humidity is highlighted.

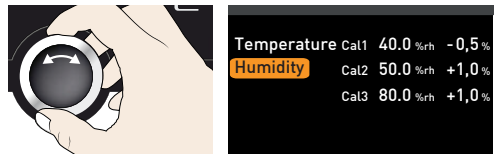

3. Press the confirmation key repeatedly, until the calibration point Cal2 is selected.

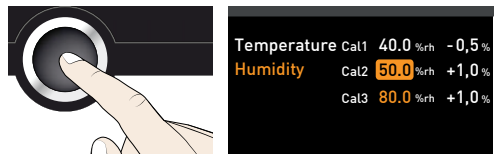

4. With the turn control, set the calibration point Cal2 to 60 % rh.

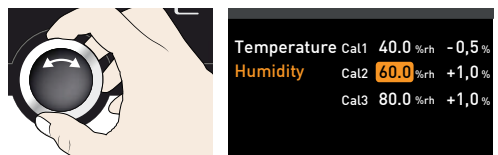

5. Save the setting by pressing the confirmation key. The corresponding calibration value is automatically highlighted.

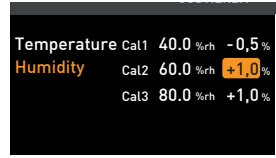
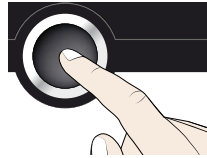

6. Set the calibration value to 0.0 K and accept the setting by pressing the confirmation key.



7. Position the sensor of the calibrated reference instrument centrally in the appliance's working chamber.
 8. Close the door and, in manual mode, adjust the set humidity to 60 % rh.

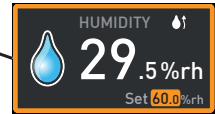
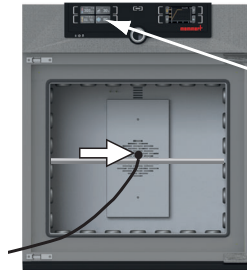

9. Wait until the appliance reaches the set humidity and displays 60 % rh. The reference instrument should display 58.5 % rh.

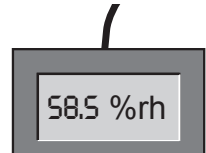
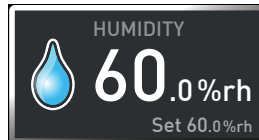

10. In the SETUP, adjust the calibration value Cal2 to -1.5 % (actual value measured minus setpoint humidity) and save the setting by pressing the confirmation key.

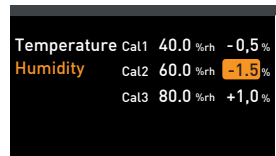

11. After the calibration procedure, the humidity measured by the reference instrument should now also be 60 % rh.

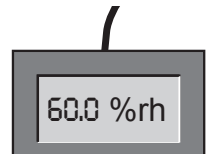
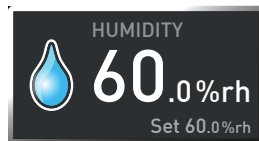

7.6 Program

In the PROG display, programmes created using the AtmoCONTROL software can be transferred to the appliance and saved on a USB storage medium. Here, programmes to be used in manual mode can also be selected (see page 32) and programmes can be deleted.

i To load a programme from a USB storage medium: Connect the USB storage medium with the saved programme(s) to the interface on the right side of the control panel.

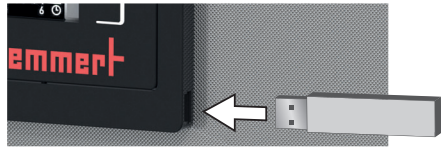

1. Activate the programme display. To do so, press the activation key on the left side of the PROG display. The display is enlarged and the entry Select automatically highlighted. The programmes available for activation are shown on the right. The programme currently available for use – in this example Test 012 – is highlighted in orange.

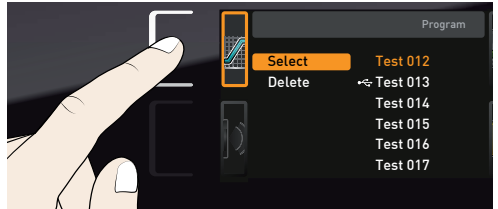

2. Call the Select function by pressing the confirmation key. All programmes available are displayed, including the ones saved on the USB storage medium (identified by the USB symbol). The programme currently available for use is highlighted in orange.

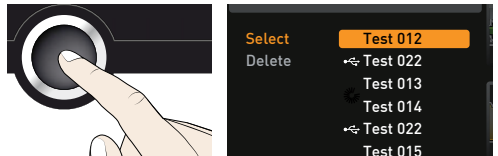

3. With the turn control, select the programme you want to make available for use.

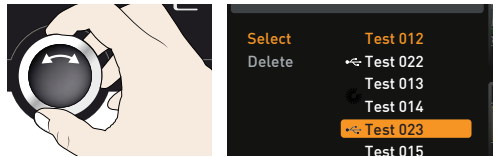

4. Accept the selection by pressing the confirmation key. The programme is now loaded, which is indicated by the transfer symbol.

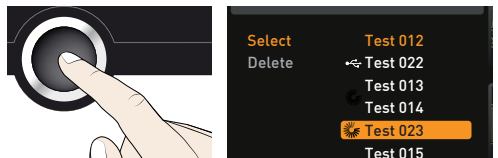

5. As soon as the programme is ready, the selection returns to Select. To start the programme: As described on page 32, return to manual mode by pressing the MENU key.

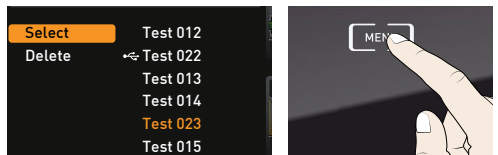

You can now remove the USB storage medium.

To delete a programme, select Delete with the turn control and select the programme to be deleted the same way you can select a programme for activation.

7.7 Sound

In the Sound display, it can be define whether or not the appliance should emit acoustic signals and, if yes, on which events:

- ▶ on the press of a key
- ▶ at the end of a programme
- ▶ on alarm
- ▶ if the door is open

1. Activate the acoustic signal adjustment. To do so, press the activation key on the left side of the SOUND display. The display is enlarged. The first category (in this case Key sound) is automatically highlighted. On the right, the current settings are shown on.

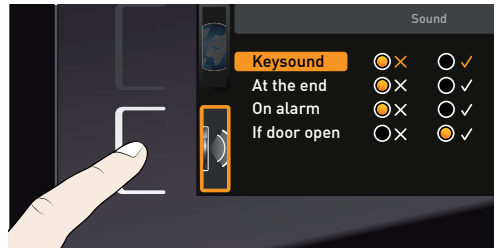

2. If you want to edit another list entry: Turn the turn control until the respective entry – e.g. If door open (Special accessories) – is highlighted in colour.

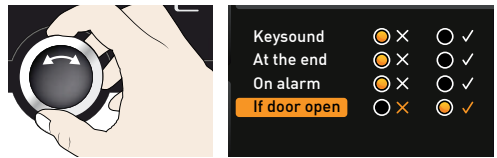

2. Save the selection by pressing the confirmation key. The adjustment options are automatically highlighted.

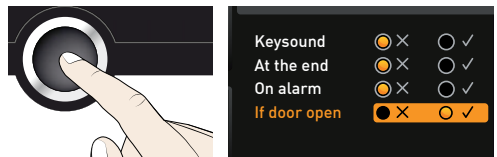

3. With the turn control, select the desired setting – in this example OFF (X) .

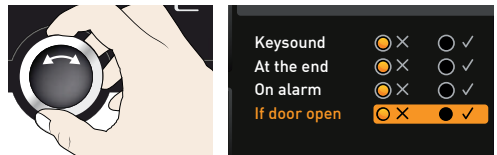

4. Save the setting by pressing the confirmation key.

5. If an acoustic alarm sounds, it can be turned off by pressing the confirmation key.

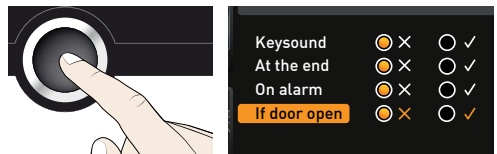

7.8 Protocol

The appliance continually logs all relevant measured values, settings and error messages at 1-minute intervals. The internal log memory is of the continuous memory type. The logging function cannot be switched off and is always active. The measured data are stored in the appliance, safe from manipulation. If the power supply is interrupted, the time of the power failure and voltage recovery are stored in the appliance.

You can export the protocol data for different periods to a USB storage medium via the USB interface or, via Ethernet, import them to the AtmoCONTROL software for graphical representation, print-out or storage.

i The log memory of the appliance is not modified or deleted by reading it out.

1. Connect the USB storage medium to the interface on the right side of the control panel.

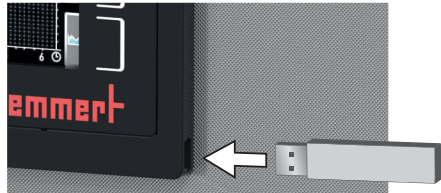

2. Activate the protocol. To do so, press the activation key on the right side of the PROTOCOL display. The display is enlarged and the period This Month automatically highlighted. To select another logging period, use the turn control.



3. Save your selection by pressing the confirmation key. The transfer starts and a status symbol indicates the progress.

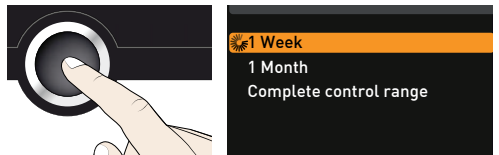

4. As soon as the transfer is complete, a check mark appears in front of the period selected. The USB storage medium can now be removed.

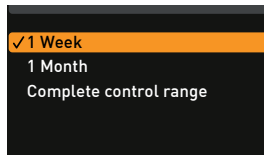

For a description of how to import and process protocol data in AtmoCONTROL or read them out via Ethernet, please observe the separate AtmoCONTROL manual.

7.9 User-ID

7.9.1 Description

With the User-ID function, you can lock the settings of individual (e.g. temperature) or all parameters, so that they cannot be changed at the appliance by accident or unauthorised persons. You can also lock setting options in menu mode (e.g. adjustment or date and time settings) this way.

● If adjustment options are locked, this is indicated by **1** the lock symbol in the respective display (Fig. 29).

User ID data are entered in the AtmoCONTROL software and saved on the USB storage medium. The USB storage medium is thus acting as a key: Parameters can only be locked or unlocked if it is connected.



A description of how to create a user ID in AtmoCONTROL is provided in the separate AtmoCONTROL manual.

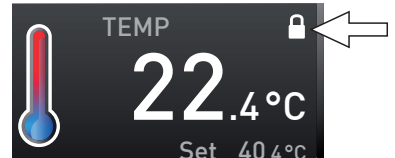
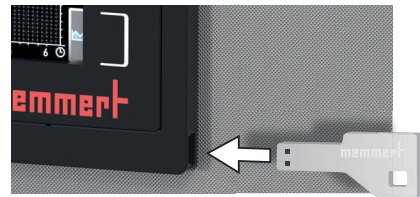

Fig. 29 Temperature adjustment at appliance locked (example)

7.9.2 User ID activation and deactivation

1. Connect the USB storage medium with the user ID data to the interface on the right side of the control panel.



2. Activate the user ID. To do so, press the activation key on the right side of the User-ID display. The display is enlarged and the entry Activate automatically highlighted.



3. Confirm the activation by pressing the confirmation key. The new user ID data are transferred from the USB storage medium and activated. As soon as activation is complete, a check mark appears in front of the corresponding entry.

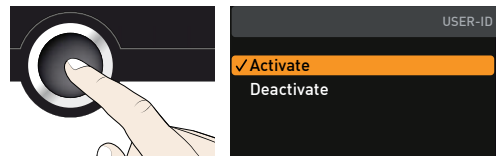

4. Remove the USB storage medium. Locked parameters are indicated by the lock symbol in the respective display (Fig. 29).

To unlock the appliance, connect the USB storage medium, activate the User-ID entry and select Deactivate.

8. Maintenance and Servicing

**Warning!**

Danger due to electric shock. Before doing any maintenance work, pull out the mains plug. Covers may only be removed by qualified electricians.

**Warning!**

In case of appliances of a certain size, you can get accidentally locked in, which is life-threatening. Do not climb into the appliance!

**Caution!**

Danger of cuts due to sharp edges. Always wear gloves when working in the chamber interior.

To guarantee perfect control, we recommend to calibrate the appliance once a year (see page 51).

8.1 Cleaning

8.1.1 Interior and metal surfaces

Regular cleaning of the easy-to-clean interior prevents build up of material remains that could impair the appearance and functionality of the stainless steel chamber over time.

The metal surfaces of the appliance can be cleaned with normal stainless steel cleaning agents. Make sure that no rusty objects come into contact with the interior or with the stainless steel housing. Rust deposits can lead to an infection of the stainless steel. If rust spots should appear on the surface of the interior due to impurities, the affected area must be immediately cleaned and polished.

8.1.2 Plastic parts

Do not clean the ControlCOCKPIT and other plastic parts of the appliance with caustic or solvent-based cleaning agents.

8.1.3 Glass surfaces

Glass surfaces can be cleaned with a commercially available glass cleaner.

8.1.4 Cooling unit

In order to guarantee perfect function and a long lifetime of the refrigeration unit, it is absolutely essential to remove dust deposits from the condenser (with a vacuum cleaner, paintbrush or bottle brush, depending on the amount of dust).

To do so, open the screws at the lower front cover (number varies depending on the appliance size) and remove the front cover (Fig. 30).



Fig. 30 Unscrew and remove the front cover

8.1.5 Peltier dehumidification modules

In order to guarantee perfect function and a long lifetime of the Peltier dehumidification modules, it is absolutely essential to remove dust deposits from the heat sink on the rear side of the appliance (with a vacuum cleaner, paintbrush or bottle brush, depending on the amount of dust) (Fig. 31).

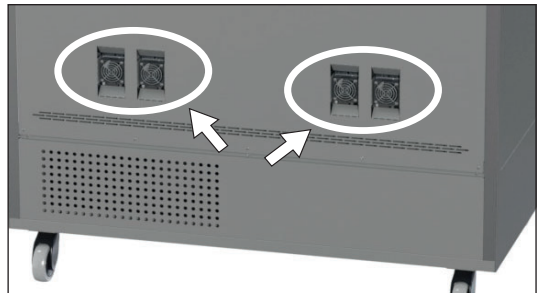

Fig. 31 Peltier cooling modules at the rear side of the appliance

8.2 Repairs and Service



Warning!

After removing covers, live parts may be exposed. You may receive an electric shock if you touch these parts. Disconnect the mains plug before removing any covers. Any work inside the appliance may only be performed by qualified electricians.



Repairs and service work are described in a separate service manual.

8.2.1 Replacing fluorescent tubes (only for model ICH L / ICH L eco)



Warning!

UV light is a danger to your eyes. Your eyes could be injured by UV light if you do not wear protection. Please always wear UV safety goggles when testing the function of fluorescent tubes.

- ▶ Replace the fluorescent tubes only with fluorescent tubes of the same power and type; e.g. UV light tubes only with UV light tubes, not daylight tubes. For information on the specifications, please refer to chapter Technical data from page 14.
 - ▶ Do not replace single tubes, but always the entire tube set (e.g. all UV light tubes instead of just one). Replacing single tubes can influence the light output.
1. Switch off the appliance and remove the mains plug.
 2. Loosen the connection of the illumination box in the interior. To do so, turn the bayonet catch to the left and pull off the plug (Fig. 32).
 3. Slightly lift the illumination box and carefully pull it out of the appliance (Fig. 33).

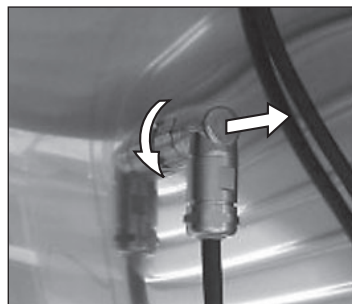

Fig. 32 Open the bayonet catch and pull off the plug



Fig. 33 Pull out the illumination box

4. Turn the illumination box around and place it carefully on a smooth surface, so that the fluorescent tubes are on top (Fig. 34). Undo the four screws on the side.
5. Loosen the screws surrounding the glass plate. Remove the glass plate and put it aside.

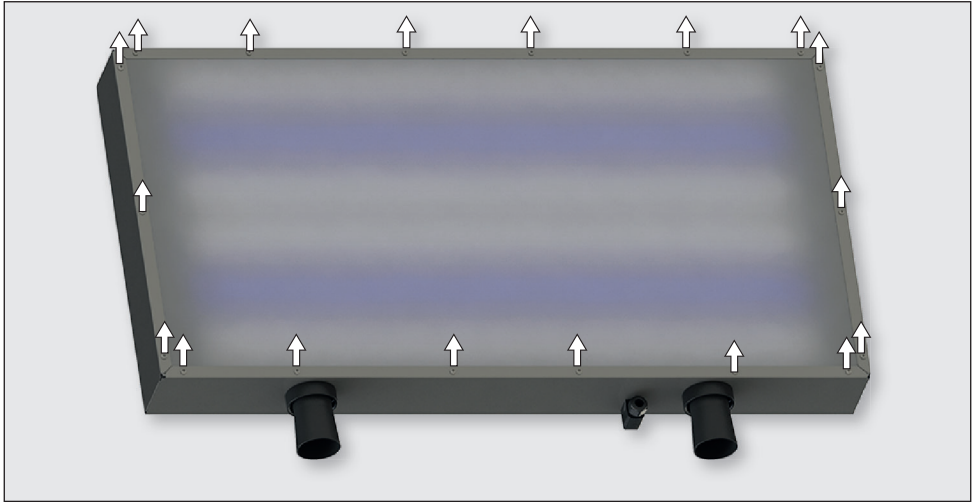

Fig. 34 Lay the illumination box on its back and loosen the screws

6. Undo the screw connections on the sockets of the fluorescent tubes to be exchanged (Fig. 35).
7. Carefully pull the fluorescent tubes out of the sockets and remove them.
8. Insert the new fluorescent tubes and screw them in tight. Put the glass plate back on and secure it.

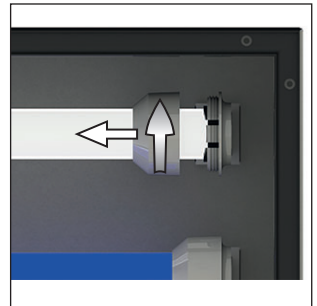

Fig. 35 Undo the screw connections

9. Push the illumination box back into the appliance. Guide the two connectors of the illumination cooling into the feed-throughs at the rear of the appliance until they click in place (Fig. 36).

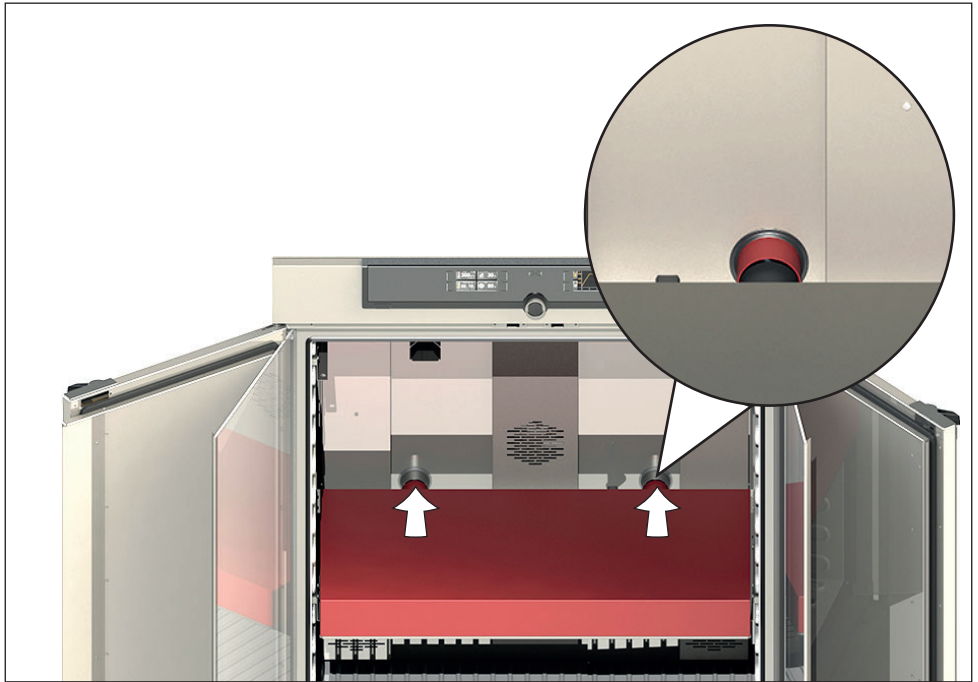

Fig. 36 Put the illumination box back in

10. Put in the plug and lock the bayonet catch by turning it right (Fig. 32).



Warning!

UV light is a danger to your eyes. Your eyes could be injured by UV light if you do not wear protection. Please always wear UV safety goggles when testing the function of fluorescent tubes.

11. Check the function of the lighting.

8.2.2 Change air filter (ICH L / ICH L eco)

To guarantee perfect operation of the appliance, the filters in the ventilation openings of the illumination box need to be regularly cleaned and where necessary, replaced.

Depending on the length of operation, ambient conditions and the quality of the inflowing air, the filters need to be cleaned every six months and replaced at least every two years.

1. Loosen and remove the screw with a slotted screwdriver.
2. Remove filter holder.
3. Clean the filter or insert a new filter and reattach the filter holder

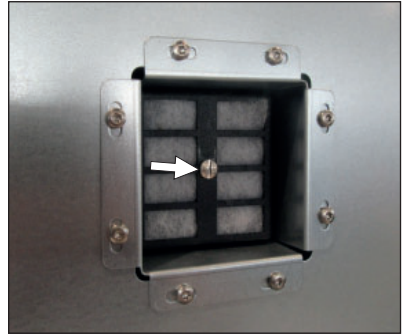

Fig. 37 illumination box air filter

9. Storage and disposal

9.1 Storage

The appliance may only be stored under the following conditions:

- ▶ in a dry and enclosed, dust-free room
- ▶ frost-free
- ▶ disconnected from the power supply

Before storage, remove water tube and empty the water tank (see page 23).

9.2 Disposal

This product is subject to the Directive 2012/19/EC on Waste Electrical and Electronic Equipment (WEEE) of the European Parliament and of the Council. This appliance has been brought to market after August 13th, 2005 in countries which have already integrated this directive into their national laws. It may not be disposed of in normal household waste. For disposal, please contact your dealer or the manufacturer. Any appliances that are infected, infectious or contaminated with materials hazardous to health are excluded from return. Please also observe all other regulations applicable in this context.

Before disposing of the appliance, please render the door locking mechanism unusable, for example, to prevent playing children from being locked inside the appliance.

There is a lithium battery in the ControlCOCKPIT of the appliance. Remove it and dispose of it in accordance with the regulations in your country (Fig. 38).

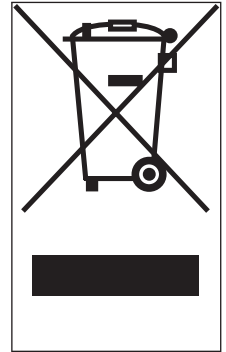

Fig. 38 Removing the lithium battery

Note for Germany:

The appliance may not be left at public or communal recycling or collection points.

Index

- A**
- Accessories 16
 - Activation key 26, 28
 - Alarm 33, 34, 36, 39
 - Ambient conditions 16
 - Ambient temperature 16
 - Appliance error 41
 - ASF 32, 34
 - AtmoCONTROL 3, 12, 16, 27, 30, 54, 56, 57
- B**
- Balance 47
 - Basic device settings 43
 - Basic settings 43
- C**
- Carrying 17
 - Cause of errors 41
 - Chamber load 25
 - Changes 9
 - Cleaning 58
 - Clock time 48
 - Communication interfaces 12
 - Compensation correction values 51
 - Connections 11
 - ControlCOCKPIT 25, 26
 - Cooling unit 47, 59
 - Customer service 2
- D**
- Daylight 28
 - Declaration of conformity 15
 - Defrost 47
 - Delete programme 54
 - Delivery 17, 18, 22
 - Digital backwards counter 29
 - Dimensions 15
 - Directives 15
 - Disposal 63
 - Door 24
- E**
- Electrical connection 11
 - Electrical equipment 11
- Electronic temperature monitoring 33
- Emergency 9
 - Ending operation 38
 - End of programme 32
 - Error description 41
 - Error messages 39
 - Ethernet 12
 - Explosion protection 9
- F**
- Fan speed 28
 - Fluorescent tubes 60, 61
 - Forklift truck 18
 - Fresh water container 22
- G**
- Graph 37
 - Grid 47
- H**
- Hazards 7
 - Hot-air generator 11
 - Humidity 28
 - Humidity adjustment 52
 - Humidity monitoring 36, 37, 41
 - Humidity profile 37
- I**
- Illumination box 11, 60, 61
 - Installation site 19
 - Intended use 9
 - Interfaces 11
 - Interior lighting 28
 - IP address 45
- L**
- Language selection 44
 - Lichtkassette 60
 - Light 28
 - Light display 28
 - Lighting 28
 - Loading the appliance 25
 - Log memory 42, 56
- M**
- Maintenance 58
 - Malfunctions 9, 39, 41
- Manufacturer 2
- Material 11
 - Mechanical temperature monitoring 34
 - Menu 48
 - Minimum clearances 19
 - Monitoring function 32
 - Monitoring temperature 32
- N**
- Nameplate 13
 - Network 12, 45
- O**
- Operating 24
 - Operating modes 27
 - Operating personnel 8, 24
 - Operating problems 41
 - Operation 24
- P**
- Packaging material 18
 - Parameter adjustment 26
 - Power failure 42
 - Power supply 56
 - Press of a key 55
 - Product safety 7
 - Programme 54
 - Programme mode 27, 30, 32
 - Protocol 56
 - Pt100 temperature sensor 32
 - Putting into operation 22
- R**
- Rectifying errors 41
 - Replacing fluorescent tubes 60
- S**
- Safety goggles 7, 8, 24, 60, 62
 - Safety labels 8
 - Safety regulations 6, 10
 - Service 60
 - Servicing 60
 - Setting parameters 44
 - Setting up 17, 19
 - Setup 45

- Shelf 47
- Slide-in unit 47
- Speaker symbol 33, 36, 39
- Standards 15
- Storage after delivery 18
- Switching off 38
- Switching on 23
- T**
- Tank holder 23
- TB 34
- Technical data 14
- Temperature 28
- Temperature adjustment 50
- Temperature comparison 50
- Temperature deviation 50
- Temperature limiter 34
- Temperature monitor 32, 34
- Temperature monitoring 32
- Temperature profile 37
- Temperature sensor 32
- Tilt protection 20
- Time 47
- Timer 29
- Timer mode 47
- Transport 17, 18
- Transport damage 18
- Türen einstellen 21
- Turn control 26, 29
- TWW 33
- TWW temperature monitoring 33
- U**
- Unit 46
- Unpacking 18
- USB interface 12, 56
- User ID 57
- UV light 7, 24, 29, 60, 62
- UV safety goggles 7, 8, 24, 60, 62
- W**
- Warning messages 12, 39
- Water specifications 22
- Water tank 22
- Weight 14
- What to do in case of accidents 9

memmert

Climate chamber

ICH / ICH eco

ICH-L / ICH-L eco

D33142 | Date 12/2019

englisch

Memmert GmbH + Co. KG
Postfach 1720 | D-91107 Schwabach
Tel. +49 9122 925-0 | Fax +49 9122 14585
E-Mail: sales@memmert.com
[facebook.com/memmert.family](https://www.facebook.com/memmert.family)