

# Instruction Manual

## Cond 6+ Conductivity/Temp

## TDS 6+ TDS/Temp

## Salt 6+ Salinity/Temp



**OAKTON**<sup>®</sup>

**EUTECH**  
**INSTRUMENTS**

*Technology Made Easy...*

CE

**ISO 9001**  
CERTIFIED

68X243635

Rev 1 Jun 2014

Part of Thermo Fisher Scientific



## **Preface**

This manual serves to explain the use of the Conductivity, TDS, and Salinity handheld meters. The models covered are the CON 6+, TDS 6+, and Salt 6+.

This manual functions in two ways: first as a step by step guide to help you operate the meter; second, it serves as a handy reference guide.

This manual is written to cover as many anticipated applications of the Conductivity, TDS, and Salinity handheld meters as possible. If there are doubts in the use of these meters, please do not hesitate to contact the nearest Eutech Instruments / Oakton Instruments Authorized Distributor.

Eutech Instruments / Oakton Instruments will not accept any responsibility for damage or malfunction to the meter caused by improper use of the instrument.

The information presented in this manual is subjected to change without notice as improvements are made, and does not represent a commitment on the part of Eutech Instruments Pte Ltd / Oakton Instruments.

Copyright © 2014

Eutech Instruments Pte Ltd

Oakton Instruments

Rev 1 Jun 2014

# Table of Contents

<b>1. INTRODUCTION</b>	<b>1</b>
<b>2. GETTING STARTED</b>	<b>2</b>
2.1 Description of Keypad Functions	2
2.2 Description of LCD Annunciators	3
2.3 Inserting & Removing the Rubber Armour / Stand	4
2.4 Inserting New Batteries	4
2.5 Battery Replacement	5
2.6 Electrode Information	5
2.7 Connecting the Electrode	6
2.8 Switching the Meter On	7
2.9 Changing Mode	8
<b>3. CALIBRATION</b>	<b>9</b>
3.1 Important Information on Meter Calibration	9
3.2 Preparing the Meter for Calibration	10
3.3 Selection of Auto or Manual Calibration (COND 6+)	10
3.4 Using Automatic Calibration (COND 6+)	11
3.5 Manual Calibration	13
3.6 Temperature Calibration	14
<b>4. MEASUREMENT</b>	<b>15</b>
4.1 With Automatic Temperature Compensation (ATC)	15
4.2 Without ATC (Manual Temperature Compensation)	15
4.3 Taking Measurements	16
4.4 Using Manual Ranging Function (COND 6+, TDS 6+)	16
4.5 HOLD Function	18
<b>5. ADVANCED SETUP FUNCTIONS</b>	<b>18</b>
5.1 Advanced Setup Overview	18
5.2 Select Cell Constant (COND 6+, TDS 6+ only)	20
5.3 Automatic Calibration (COND 6+ only)	20
5.4 Setting the TDS Factor (TDS 6+ only)	21
5.5 Temperature Coefficient	21
5.6 Normalization Temperature	22
5.7 Single-Point Calibration (COND 6+, TDS 6+ only)	22
5.8 Restore Factory Default Values	23
<b>6. PROBE CARE AND MAINTENANCE</b>	<b>23</b>
<b>7. TROUBLESHOOTING</b>	<b>24</b>
<b>8. SPECIFICATIONS / FEATURES</b>	<b>25</b>
<b>9. CONDUCTIVITY THEORY</b>	<b>27</b>

<b>10. CALIBRATION TIPS.....</b>	<b>29</b>
<b>11. CALCULATING TDS CONVERSION FACTOR .....</b>	<b>30</b>
<b>12. CALCULATING TEMPERATURE COEFFICIENTS .....</b>	<b>31</b>
<b>13. REPLACEMENTS AND ACCESSORIES .....</b>	<b>32</b>
<b>14. WARRANTY .....</b>	<b>33</b>
<b>15. RETURN OF ITEMS .....</b>	<b>33</b>

## 1. INTRODUCTION

Thank you for purchasing the COND 6+, TDS 6+, or SALT 6+ meter. These microprocessor-based handheld meters are economical and easy to use. It has a large custom LCD (Liquid Crystal Display) for clear and easy reading.

The Cond 6+ measures conductivity ( $\mu\text{S}/\text{cm}$  or  $\text{mS}/\text{cm}$ ) and temperature ( $^{\circ}\text{C}$ ) while the TDS 6+ measures total dissolved solids (TDS) in parts per million (ppm) or parts per thousand (ppt) and temperature ( $^{\circ}\text{C}$ ). Each measures up to 5 different ranges and can automatically switch to appropriate measuring range.

The Salt 6+ measures salinity (as NaCl) in % salt or ppt and temperature ( $^{\circ}\text{C}$ ).

Your meter includes an electrode (cell constant  $K = 1.0$ ) with built-in temperature sensor (ECCONSEN91B), rubber armour, 4 alkaline "AAA" batteries, instruction manual and warranty card.

Please read this manual thoroughly before operating your meter.

To order other accessories and buffer standard solutions, please refer to the accessories section for more information.

## 2. GETTING STARTED

### 2.1 Description of Keypad Functions

Your meter has 6 keys on its splash-proof keypad. Some buttons have multiple functions depending on the mode of operation.

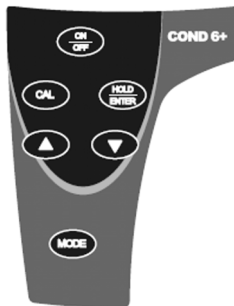

**ON/OFF** Powers meter on and off. Meter starts up in the measurement mode that you last switched off from.

**CAL** Enters into calibration mode. Pressing while in calibration mode will abort calibration without confirming value.

**MODE** Selects desired measurement mode. When pressed simultaneously with ON/OFF, it will take you into the SETUP mode. See ADVANCED SETUP section for more information.

**HOLD** Freezes measured reading. Press again to resume live reading.

**ENTER** Confirms calibration value in calibration mode and confirm selections in SETUP mode.

▲ Increment values during calibration mode or scroll through SETUP. Activates manual ranging function during conductivity / TDS measurement.

▼ Decrement values during calibration mode.

## 2.2 Description of LCD Annunciators

Your meter has a large custom LCD that consists of 4-digit segments plus annunciators for  $\mu\text{S}/\text{mS}$  (Cond 6+),  $\text{ppm}/\text{ppt}$  (TDS 6+), or  $\text{ppt}/\%$  (Salt 6+) and  $^{\circ}\text{C}$  (temperature).

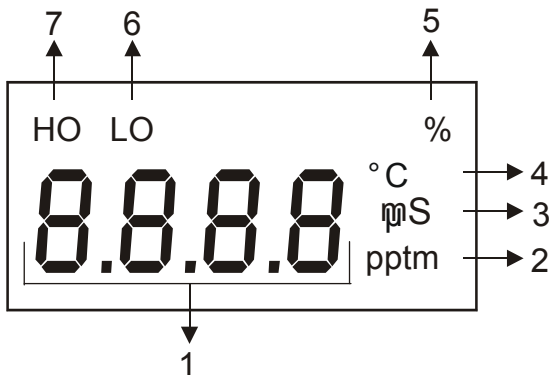

1. Primary display
2. Parts per million (ppm) (TDS 6+ only).  
Parts per thousand (ppt) (TDS 6+ & Salt 6+ only).
3. Milli-Siemens/cm (mS) or micro-Siemens/cm ( $\mu\text{S}$ ) indicator (Cond 6+ only).
4. Temperature indicator.
5. Percentage indicator for temperature coefficient or % Salinity (Salt 6+ only).
6. "LO" = low battery condition.
7. "HO" = HOLD function is activated and reading is frozen.



## 2.3 Inserting & Removing the Rubber Armour / Stand

1. To remove meter from rubber armour, push out from the bottom edges of meter until it is completely out of boot. Ensure that your electrode cables are not connected. **Figure A.**
2. To insert meter into armour, slide in from the top of meter before pushing the bottom edges of meter down to set it into position. Lift up the stand at the back of meter for bench top applications if necessary. **Figure B.**

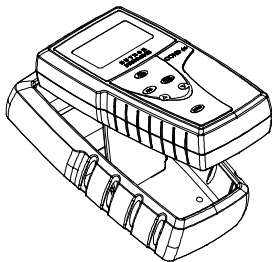

Figure A

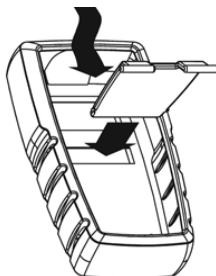
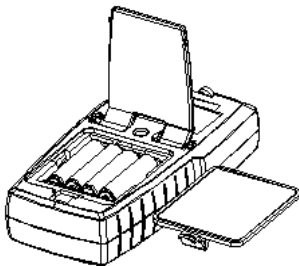
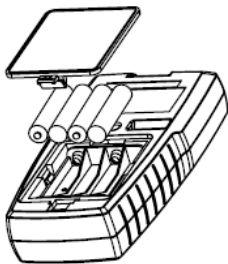

Figure B

## 2.4 Inserting New Batteries

The battery compartment is found at the back of instrument. To open the battery compartment, push in the direction of arrow and lift up the cover. Note the polarity of battery before inserting into position. After replacement, place cover back and press down until it locks.



## 2.5 Battery Replacement

A "LO" annunciator in the LCD alerts you when battery power is running low. See below.

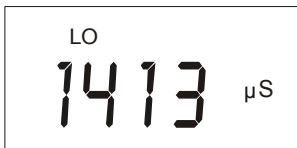

"LO" Battery Condition

*Caution: Power off the meter when changing battery.*

## 2.6 Electrode Information

Your meter includes an electrode with a BNC connector (EC-CONSEN91B) having a nominal cell constant of  $k = 1.0$ , and a built-in temperature sensor. The Ultem-body housing has good chemical resistant properties. The electrode design offers fast temperature response and reduces air entrapment, ensuring accurate, repeatable, and stable readings.

The wettable materials of the probe include:

1. Polyetherimide (Ultem) – protective probe guard
2. Polybutylterphalate (Valox) – sensor housing
3. Stainless Steel (SS 304) – 2 steel bands

The protective probe guard can be removed temporarily for maintenance but must be re-attached during measurement and calibration. *Erroneous results will occur while the probe guard is removed.*

Always immerse the probe beyond upper steel band for best results. Use the fill line on the outside of the probe guard for reference.

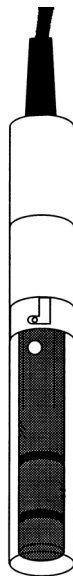

1. DO NOT measure or calibrate without the protective probe guard in place.
2. Immersion above the protective guard is not recommended. The cable can be submerged briefly but is not designed for continuous immersion.

See *"Probe Care and Maintenance"* for more information.

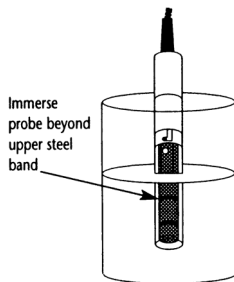

## 2.7 Connecting the Electrode

1. To connect electrode, align the connector slots with the posts of meter's socket and rotate connector clockwise until it locks.
2. To remove, rotate the connector in anti-clockwise direction until it unlocks, and slide the connector off the socket.
3. Insert the mini phono jack of temperature sensor into the socket on the meter as shown below.

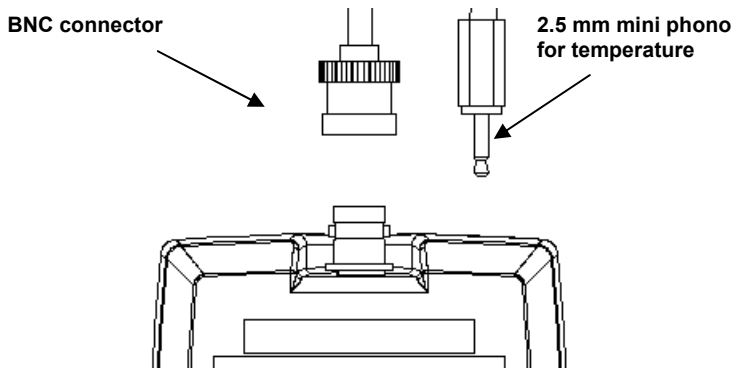

## 2.8 Switching the Meter On

Press **ON/OFF** to power up your meter. Your meter will cycle through various setup parameters when switched on.

1. The first screen shows the model [**Con6**] [**tdS6**] [**SAL6**].
2. The second screen shows the nominal cell constant value. The Cond 6+ and TDS 6+ meters can accept electrodes with  $k = 0.1$ , 1.0 or 10.0 nominal cell constants. The Salt 6+ can be used with 1.0 only. Default value is  $k = 1.0$  [**C 1.0**].

See Section 5.2 *Advanced Setup* to modify.

3. The third screen shows the Normalization Temperature which can be set to 25 °C or 20 °C. Default value is 25 °C [**t 25.0 °C**].

See Section 5.6 *Advanced Setup* to modify.

4. The fourth screen shows the Temperature Coefficient which can be set from 0.0 to 3.0 % per °C. Default value is 2.1 %/°C [**t 2.1%**].

See Section 5.5 *Advanced Setup* to modify.

5. All LCD segments light for 2 seconds before entering measurement mode. Note: the meter will use the measurement mode that was in use when it was previously powered off.

### Cond 6+

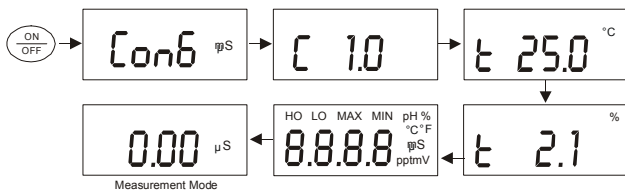

### TDS 6+

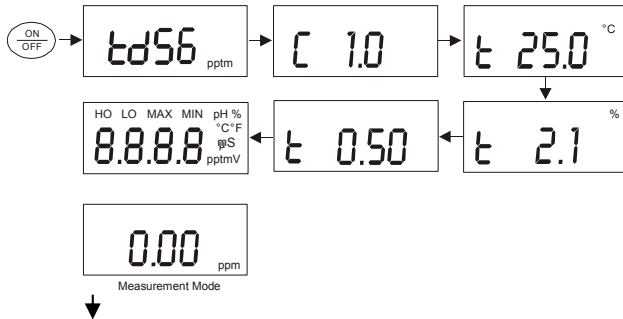

### Salt 6+

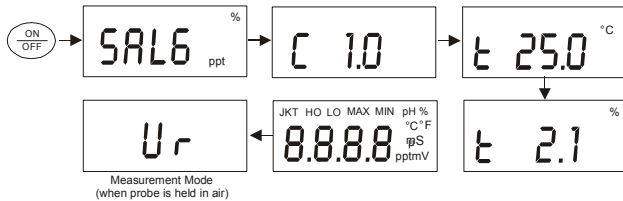

## 2.9 Changing Mode

To switch between conductivity/TDS/salinity measurement mode and temperature measurement mode, simply press the **MODE** key.

The annunciator will indicate the measurement mode you are in.

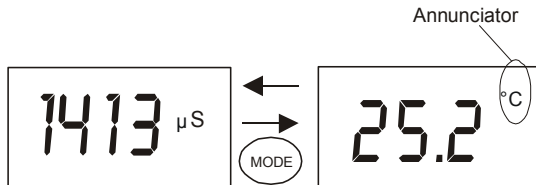

## 3. CALIBRATION

### 3.1 Important Information on Meter Calibration

The COND 6+ and TDS 6+ have five measuring ranges listed below. Each range can be calibrated to one point per range (five total points if each range is calibrated). Calibration is recommended for each range that will be utilized.

The Salt 6+ meter uses a special algorithm for the measurement of sodium chloride concentration. A one-point calibration anywhere in the measurement range is all that is needed to achieve specified accuracies for the entire measurement range.

<b>COND 6+</b>	<b>Conductivity Range</b>	<b>Recommended Calibration Solution Range</b>
	0.00 → 20.00 $\mu\text{S/cm}$	6.00 to 17.00 $\mu\text{S/cm}$
	0.0 → 200.0 $\mu\text{S/cm}$	60.0 to 170.0 $\mu\text{S/cm}$
	0 → 2000 $\mu\text{S/cm}$	600 to 1700 $\mu\text{S/cm}$
	0.00 → 20.00 $\text{mS/cm}$	6.00 to 17.00 $\text{mS/cm}$
	0.0 → 200.0 $\text{mS/cm}$	60.0 to 170.0 $\text{mS/cm}$
<b>TDS 6+</b>	<b>TDS Range</b>	<b>Recommended Calibration Solution Range</b>
	0.00 → 10.00 ppm	3.00 to 8.50 ppm
	10.0 → 100.0 ppm	30.0 to 85.0 ppm
	100 → 1000 ppm	300 to 850 ppm
	1.00 → 10.00 ppt	3.00 to 8.50 ppt
	10.0 → 200 ppt	30.0 to 170 ppt
<b>SALT 6+</b>	<b>Salinity Range</b>	<b>Recommended Calibration Solution Range</b>
	0.10 → 5.00 %	0.15 → 4.25 %
	1.0 → 50.0 ppt	1.5 → 42.5 ppt

New calibrations replace old calibrations on a per range basis. For example, if the meter has been calibrated with 1413  $\mu\text{S/cm}$  (0 to 2000  $\mu\text{S/cm}$  range) and a calibration is performed with 1500  $\mu\text{S/cm}$  (also 0 to 2000  $\mu\text{S/cm}$  range), the meter will replace the 1413  $\mu\text{S/cm}$  calibration in that range. The meter will retain all calibration data in other ranges.

When the electrode is replaced, it is best to clear all calibration data. To erase all calibration data completely, see *Section 5.8 Restore Factory Default Values*.

### 3.2 Preparing the Meter for Calibration

For best results, select a standard value close to the sample value you are measuring. Alternatively, use a calibration solution value that is approximately 2/3 the full-scale value of the measurement range you plan to use. For example, in the 0 to 2000  $\mu\text{S}/\text{cm}$  conductivity range, use a 1413  $\mu\text{S}/\text{cm}$  solution for calibration.

Use fresh calibration standard solutions. Reuse of standard solutions may impair calibration and accuracy of measurements. Store solutions in a dry, dark, and cool environment when possible while limiting exposure to air.

Rinse or immerse the probe before calibration and between samples with clean water (deionized water is ideal).

### 3.3 Selection of Auto or Manual Calibration (COND 6+)

The COND 6+ is capable of automatic or manual calibration. The factory default setting is automatic.

In the automatic calibration mode, the COND 6+ will automatically select one of (4) calibration standard values (see below) depending on the range and normalization temperature being used.

Automatic calibration is useful when all your calibration standards fall into one of the groups listed below. For example, if your 1413  $\mu\text{S}/\text{cm}$  standard reads as 1400  $\mu\text{S}/\text{cm}$  during calibration, you would simply press "ENTER" to accept this value using automatic mode. In manual mode, you would have needed to press the increment button 13 times before pressing "ENTER". If you will use a calibration standard that is not listed below, select manual calibration instead.

Normalization Temperature	Calibration Standards (Range)
25 °C	1. <b>84 <math>\mu\text{S}/\text{cm}</math></b> (for 0 – 200 $\mu\text{S}/\text{cm}$ ) 2. <b>1413 <math>\mu\text{S}/\text{cm}</math></b> (for 0 – 2000 $\mu\text{S}/\text{cm}$ ) 3. <b>12.88 mS/cm</b> (for 0.00 – 20.00 mS/cm) 4. <b>111.8 mS/cm</b> (for 0.0 – 200.0 mS/cm)
20 °C	1. <b>76 <math>\mu\text{S}/\text{cm}</math></b> (for 0 – 200 $\mu\text{S}/\text{cm}$ ) 2. <b>1278 <math>\mu\text{S}/\text{cm}</math></b> (for 0 – 2000 $\mu\text{S}/\text{cm}$ ) 3. <b>11.67 mS/cm</b> (for 0.00 – 20.00 mS/cm) 4. <b>102.1 mS/cm</b> (for 0.0 – 200.0 mS/cm)

**Table 1: Conductivity Calibration Standards for Auto Calibrations**

With manual calibration, you are not limited to the calibration standard values listed previously. Manual calibration is useful when you wish to use one or more standard values that are not listed above.

See Section 5.3 *Advanced Setup* to modify automatic or manual calibration.

### 3.4 Using Automatic Calibration (COND 6+)

In Automatic Calibration mode, the COND 6+ can accept up to 4 calibration points with maximum of 1 point per measurement range. Note: values in the 0.00 to 20.00  $\mu\text{S}/\text{cm}$  range cannot be calibrated in Auto Calibration mode.

1. If necessary, press **MODE** key to select conductivity mode.
2. Rinse the probe with deionized water or a rinse solution, then rinse with a small amount of calibration standard.

**NOTE: For Automatic Calibration you must use one of the calibration standards listed in Table 1.**

3. Dip the probe into the calibration standard. Stir the probe gently to create a homogeneous sample. Allow time for the reading to stabilize.
4. Press **CAL** key to enter conductivity calibration mode. The [CA] indicator will appear briefly, then a value will appear flashing.

**NOTE: To exit calibration without confirmation, press CAL to return to measurement mode.**

5. When the value is stable, press **ENTER**. The calibration standard value will appear for 3 seconds. If the calibration is successfully performed, [done] will be displayed briefly before meter returns to measurement mode.
6. Repeat steps 1-5 as needed with additional calibration standards.

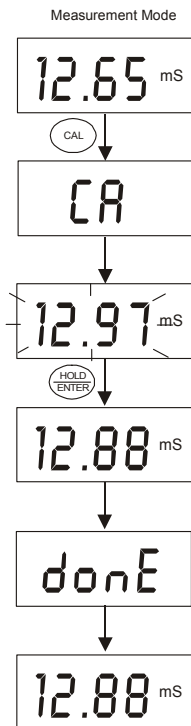



**NOTES:**

1. *To protect from erroneous calibrations, the allowable tolerance is  $\pm 40\%$  of the factory default value. If calibration is attempted with standards that fall outside this tolerance range, the error message **"Err 1"** is indicated and meter will return to measurement mode. For example, a 40% tolerance of a 1413  $\mu\text{S}/\text{cm}$  standard, is 848  $\mu\text{S}/\text{cm}$  to 1978  $\mu\text{S}/\text{cm}$ .*
2. *If the measured temperature ( $^{\circ}\text{C}$ ) of the calibration solution is below 0  $^{\circ}\text{C}$  or above 50  $^{\circ}\text{C}$ , the error message **"Err 2"** is indicated and meter will return to measurement mode.*
3. *Low conductivity standard solutions (less than 20  $\mu\text{S}/\text{cm}$ ) are unstable and are very temperature dependent. As a result, reproducible calibration results are challenging in lowest measurement range (0.00 to 20.0  $\mu\text{S}/\text{cm}$ ).*

### 3.5 Manual Calibration

In Manual Calibration mode you are not limited to the conductivity calibration standards listed previously in Table 1. This example shows a manual calibration sequence using a 12.00 mS/cm conductivity calibration standard.

1. If necessary, press **MODE** key to select conductivity mode.
2. Rinse the probe thoroughly with de-ionized water or a rinse solution, then rinse with a small amount of calibration standard.
3. Dip the probe into the calibration standard. Stir the probe gently to create a homogeneous sample. Allow time for the reading to stabilize.
4. Press **CAL** to enter conductivity calibration mode. The [CA] indicator will appear briefly, then a value will appear flashing.

**NOTE: To exit calibration without confirmation, press CAL to return to measurement mode.**

5. When the value is stable, press **▲** or **▼** as needed to adjust the value to match your calibration standard.
6. Press **ENTER** to confirm the adjusted value. [CO] will appear briefly indicating that the calibration was successful. The meter returns to measurement mode.
7. Repeat steps 1-6 as needed with additional calibration standards.

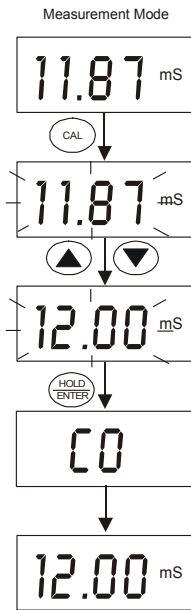

### 3.6 Temperature Calibration

The electrode includes a built-in temperature sensor that is factory calibrated with the meter. Perform temperature calibration only if you suspect temperature errors may have occurred over time or when the probe is replaced.

You can offset the temperature reading up to  $\pm 5$  °C from the original (default) reading.

1. Connect the mini phono plug of the electrode to the meter. See Section 3.7.
2. If necessary, press **MODE** to select temperature measurement mode.
3. Press **CAL** to initiate temperature calibration. "CA" will appear briefly then a temperature value will start flashing.
4. Dip the probe into a solution with known temperature (for example, a temperature bath). Allow time for the temperature to stabilize.
5. When the value is stable, press **▲** or **▼** as needed to adjust the value to the solution temperature.
6. Press **ENTER** to confirm the adjusted value. [CO] will appear briefly indicating that the calibration was successful. The meter returns to measurement mode.

**NOTE:** To exit calibration without confirmation, press **CAL** to return to measurement mode.

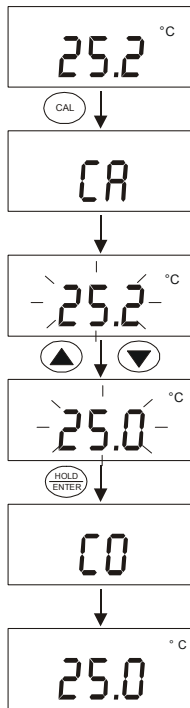

## 4. MEASUREMENT

Your meter is capable of taking measurements that incorporate temperature measurements automatically (most common) or using a temperature which you input manually (rare).

### 4.1 ***With Automatic Temperature Compensation (ATC)***

To compensate your reading using temperature values as measured by your electrode, simply attach the phono plug of the electrode to the meter. The measured reading is automatically compensated to the specified normalization temperature (either 20 °C or 25 °C). The rate of compensation which is applied is the Temperature Coefficient.

*See Section 5.5 – Temperature Coefficient.*

*See Section 5.6 – Normalization Temperature.*

### 4.2 ***Without ATC (Manual Temperature Compensation)***

You can use manual temperature compensation after manually entering the temperature value of your process into the meter. The meter will then compensate from this fixed value to the normalization temperature. Any temperature can be used between 0 and 50 °C. The default value is 25 °C.

To activate manual temperature compensation, simply unplug the temperature sensor from the meter (mini phono plug) and follow the steps 2 thru 6 of Temperature Calibration.

*See Section 3.6 – Temperature Calibration.*

### 4.3 Taking Measurements

1. Rinse the electrode with de-ionized or distilled water before use to remove any impurities. Shake or air dry. To avoid contamination or sample dilution, rinse probe with a small volume of your sample.
2. Dip the probe into the sample.
3. Allow time for the reading to stabilize. Note the reading on the display.

**NOTE:**

*The protective probe guard must be attached during measurement. Erroneous results will occur while the probe guard is removed.*

*Always immerse the probe beyond upper steel band for best results. Use the fill line on the outside of the probe guard for reference.*

### 4.4 Using Manual Ranging Function (COND 6+, TDS 6+)

By default your meter has auto-ranging ability and automatically selects the range in which your readings appear.

Alternatively, to override auto-ranging you can manually select a specific range by pressing ▲ successively for each measurement range. The five ranges are:

<b>Conductivity Range (CON 6+)</b>	<b>TDS Range (TDS 6+) (using 0.5 TDS factor)</b>
0 – 20.00 $\mu$ S/cm	0 – 10.00 ppm
0 – 200.0 $\mu$ S/cm	0 – 100.0 ppm
0 – 2000 $\mu$ S/cm	0 – 1000 ppm
0 – 20.00 mS/cm	0 – 10.00 ppt
0 – 200.0 mS/cm	0 – 100 ppt

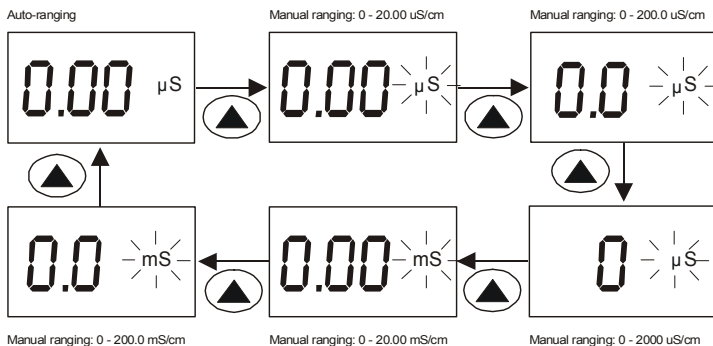
**NOTE:**

*If the value of the solution you are measuring is higher than the range selected [Or] (over range) will appear. Press ▲ to select a measurable range.*

*The meter resets to Auto-ranging function once it is turned off. You will have to reset the manual ranging function each time you turn the meter off.*

## 4.5 HOLD Function

For prolonged observation of a reading, press **HOLD** while in measurement mode to freeze the display.

- To hold a measurement, press **HOLD** while in measurement mode. **[HO]** will appear on the display.
- To release the held value, press the **HOLD** again. **[HO]** will disappear and measure is resumed.

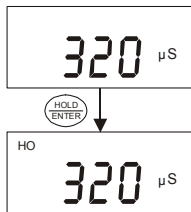

### **NOTE:**

*This meter shuts off automatically after 20 minutes of the last key press.*

*If the meter is shut off either automatically or manually, the HOLD value will be lost.*

## 5. ADVANCED SETUP FUNCTIONS

### 5.1 Advanced Setup Overview

Advanced setup allows customization settings such as; selecting electrode's cell constant, normalization temperature, temperature coefficient, TDS factor (TDS 6+), automatic or manual calibration (COND 6+), single-point or multi-point calibrations (COND 6+ and TDS 6+), and to reset meter to factory default.

To enter advanced setup mode:

- Switch off the meter.
- Press **MODE** and then **ON**, holding both keys for 2 seconds. Release the **ON** key before releasing the **MODE** key.
- If successful, **[StUP]** will appear briefly followed by **[CELC]** (for COND 6+ and TDS 6+) or **[tCo%]** (for SALT 6+).
- Press **▲** or **▼** to select the desired advanced setup function.

---

STUPEntering Advanced Setup Mode

---

CELC

Cell Constant. Select k = 0.1, 1.0, or 10.0.

Default value is 1.0. (**COND 6+, TDS 6+ only**)

---

ACAL

Select Automatic Calibration. "Yes" for auto calibration and "No" for manual calibration.

Default value is "Yes". (**COND 6+ only**)

---

t.Co<sup>°</sup>

Adjust Temperature Coefficient from 0.0 to 3.0 % per °C.

Default value is 2.1 % per °C.

---

t.nr<sup>°</sup>C

Normalization Temperature. Select "20 °C" or "25 °C".

Default value is 25 °C.

---

tdS

Adjust TDS factor from 0.4 to 1.0.

Default value is 0.5. (**TDS 6+ only**)

---

S.P.CA

Select Single Point Calibration. Select "Yes" or "No".

Default value is "Yes".

---

SALTSelect Measurement Unit, TDS (ppt) or percentage (%). (**SALT 6+ only**)

---

UrSt

User reset to factory defaults. Select "Yes" or "No".

Default value is "no".

---

**Overview of Advanced Setup**



## 5.2 Select Cell Constant (COND 6+, TDS 6+ only)

Your meter includes a probe with a nominal cell constant (k) of 1.0. Use probes with k = 0.1 and 10 (sold separately) for improved performance in extreme samples. Use this setup function to change the cell constant if necessary. Meter default is 1.0 to match the included probe.

k = 0.1 ideal for low measurements <20  $\mu\text{S}/\text{cm}$  (<10 ppm).

k = 1.0 ideal for mid-range measurements

k = 10 ideal for high measurements >20 mS/cm (>10 ppt).

1. Enter advanced setup as described in Section 5.1.
2. Press **▲** or **▼** until [CELC] appears. Press **ENTER**.
3. Press **▲** or **▼** to select “1.0”, “0.1” or “10.0”. Ensure that the cell constant corresponds with the electrode you are using.
4. Press **ENTER** to select and return to [CELC] setup function.
5. Press **▲** or **▼** to move to the next setup function or press **CAL** to exit to measurement mode.

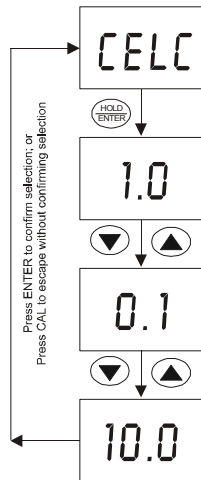

## 5.3 Automatic Calibration (COND 6+ only)

Select automatic calibration “YES” for easy calibration of (4) factory pre-set conductivity calibration standards (see Section 3.3 Table 1). To use other standards or to calibrate any standard manually select “no”. Default value is “YES”.

1. Enter advanced setup as described in Section 5.1.
2. Press **▲** or **▼** until [ACAL] appears. Press **ENTER**.
3. Press **▲** or **▼** to select [YES] or [no].
4. Press **ENTER** to select and return to [ACAL] setup function.
5. Press **▲** or **▼** to move to the next setup function or press **CAL** to exit to measurement mode.

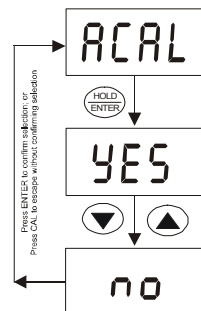

## 5.4 Setting the TDS Factor (TDS 6+ only)

The concentration of salts dissolved in solution increases the conductivity. This relationship varies from salt to salt and is roughly linear over a given range for a given salt. The TDS conversion factor is the number used by the meter to convert from conductivity to TDS.

The TDS conversion factor can be set from 0.4 to 1.0. Default value is 0.5.

See Section 13 – Calculating TDS Conversion Factor .

1. Enter advanced setup as described in Section 5.1.
2. Press ▲ or ▼ until [tdS] appears. Press **ENTER**.
3. Press ▲ or ▼ to select the desired TDS factor.
4. Press **ENTER** to select and return to the [tdS] setup function.
5. Press ▲ or ▼ to move to the next setup function or press **CAL** to exit to measurement mode.

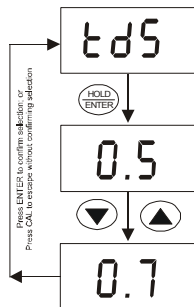

## 5.5 Temperature Coefficient

The temperature coefficient is the amount of change in conductivity per degree temperature (% per °C). For best results, determine and enter the exact temperature coefficient of your solution. The meter allows adjustment from 0.0 to 3.0 % per °C. Default value is 2.1 % per °C.

**Note:** Select 0.0 % for uncompensated measurements. Temperature can be measured by probe and displayed.

See Section 14 – Calculating Temperature Coefficients.

1. Enter advanced setup as described in Section 5.1.
2. Press ▲ or ▼ until [t.Co %] appears. Press **ENTER**.
3. Press ▲ or ▼ to select a value between 0.0 to 3.0%.
4. Press **ENTER** key to select and return to the [t.Co %] setup function.
5. Press ▲ or ▼ to move to the next setup function or press **CAL** to exit to measurement mode.

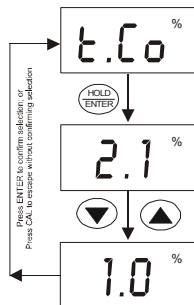

## 5.6 Normalization Temperature

You can set the meter to normalize its measurements to a temperature of either 25 °C or 20 °C. Default value is 25 °C.

1. Enter advanced setup as described in Section 5.1.
2. Press ▲ or ▼ until [t.nr °C] appears. Press **ENTER**.
3. Press ▲ or ▼ to select [25.0 °C] or [20.0 °C].
4. Press **ENTER** to select and return to the [t.nr °C] setup function.
5. Press ▲ or ▼ to move to the next setup function or press **CAL** to exit to measurement mode.

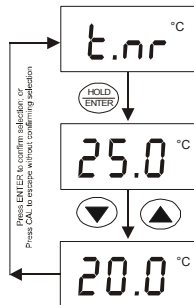

## 5.7 Single-Point Calibration (COND 6+, TDS 6+ only)

Select “YES” to apply a single calibration value across all ranges.

Select “no” to allow separate calibrations for each range, or to restrict an individual calibration so that it is applied to one range only. Default value is “Yes”.

1. Enter advanced setup as described in Section 5.1.
2. Press ▲ or ▼ until [S.P.CA] appears. Press **ENTER**.
3. Press ▲ or ▼ to select [Yes] or [no].
4. Press **ENTER** to select and return to the [S.P.CA] setup function.
5. Press ▲ or ▼ to move to the next setup function menu or press **CAL** to exit to measurement mode.

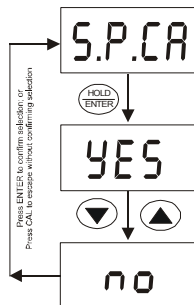

## 5.8 Restore Factory Default Values

Use this function to reset all parameters to factory default settings. This clears all calibration data and any other setup functions you might have changed.

**IMPORTANT:** Once activated the settings and calibration data will be erased and can not be undone.

1. Enter advanced setup as described in Section 5.1.
2. Press ▲ or ▼ key until [UrSt] appears. Press **ENTER**.
3. Press ▲ or ▼ to select [Yes] or [no].
4. Press **ENTER** to confirm.
5. If reset [Yes] confirmed, the meter will return to measurement mode after initialization.

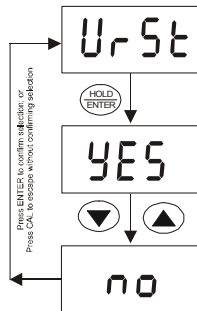

## 6. PROBE CARE AND MAINTENANCE

Keep the probe clean. Rinse the probe twice, and gently swirl it while you take readings. For best results, soak a dry probe for at least 5-10 minutes before calibration. Rinse the probe with clean water before storing. Never scratch the bands with an abrasive or hard substance. Do not strike against hard surfaces or submerge the cable for extended periods.

Do not immerse the probe in oily solutions, aggressive solvents, or strong acids. Clean with a mild detergent or isopropyl alcohol then rinse thoroughly. Dry storage is acceptable. Recalibrate after cleaning.

The included conductivity probe (EC-CONSEN91B) features a removable probe guard for easy cleaning. To remove — grip yellow probe guard and twist clockwise to release locking notch, then slide off.

**NOTE:** Remember to re-attach the probe guard — failure to do so will result in erroneous readings!

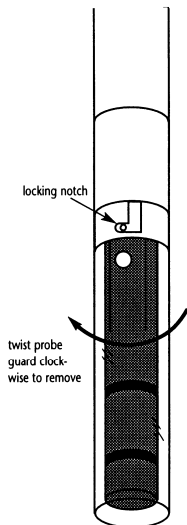

## 7. TROUBLESHOOTING

Problem	Cause	Solution
No display	Batteries are not installed, were improperly installed, or are too weak	Install batteries with correct + / - polarity. Replace with new batteries
"LO" displays in the LCD	Low battery	Replace batteries
Unstable readings	<ul style="list-style-type: none"> <li>a) Air bubbles in probe</li> <li>b) Dirty probe</li> <li>c) Probe not immersed enough</li> <li>d) External noise pickup or induction caused by nearby electric motor</li> <li>e) Broken probe</li> </ul>	<ul style="list-style-type: none"> <li>a) Tap probe to remove bubbles</li> <li>b) Clean probe &amp; recalibrate</li> <li>c) Make sure sample entirely covers the probe sensors</li> <li>d) Move or switch off interfering motor</li> <li>e) Replace probe</li> </ul>
Slow response	Dirty / Oily probe	Clean & recondition probe
Inaccurate readings / can't calibrate	Probe guard not installed or calibration solution incorrect	Install probe guard & replace calibration solutions
"Er1" COND 6+ TDS 6+	Attempted calibration value was not within the $\pm 40\%$ auto calibration window	<p>Check the value of the conductivity calibration solution.</p> <p>Switch to manual calibration mode and re-calibrate</p>
"Er1" SALT 6+	Salinity calibration error—CAL key was pressed in Under range "Ur" or Over range "Or" condition	Immerse the probe in a calibration solution between 1.0 - 50 ppt
"Er2" Temperature calibration error	Auto calibration was not within (0 – 50 °C) temperature range	Ensure that the temperature is within the acceptable range

## 8. SPECIFICATIONS / FEATURES

		COND 6+	TDS 6+	SALT 6+
Conductivity Ranges (Resolution)	0 to 20.00 (0.01) $\mu\text{S/cm}$ 20.0 to 200.0 (0.1) $\mu\text{S/cm}$ 200 to 2000 (1) $\mu\text{S/cm}$ 2.01 to 20.00 (0.01) $\text{mS/cm}$ 20.1 to 200.0 (0.1) $\text{mS/cm}$	✓		
TDS Ranges (Resolution)	0 to 10.00 (0.01) ppm 10.0 to 100.0 (0.1) ppm 100 to 1000 (1) ppm 1.01 to 20.00 (0.01) ppt 20.1 up to 200.0* (0.1) ppt *depending on TDS factor used		✓	
Salinity % Resolution	0.10 to 5.00 % 0.01%			✓
Salinity ppt Resolution	1.0 to 50.0 ppt 0.1 ppt			✓
Accuracy	$\pm 1\%$ full scale	✓	✓	✓
Temperature Resolution Accuracy	-10.0 to 110.0 °C 0.1 °C $\pm 0.5$ °C	✓	✓	✓
Cell Constant	Selectable	0.1, 1, 10	0.1, 1, 10	0.1, 1, 10
Temperature Compensation	Automatic / Manual (from 0 to 50 °C)	✓	✓	✓
Temperature Coefficient	0.0 to 3.0% per °C	✓	✓	✓
Normalization Temperature	25.0, 20.0 °C (selectable)	✓	✓	✓
TDS factor	0.4 to 1.0	✓	✓	
Calibration points	Maximum 1 per range	5	5	1
Auto- or Manual-ranging	Selectable (except Salt 6+)	✓	✓	
Auto standard recognition	Selectable (except Salt 6+)	✓		

<b>FEATURES</b>	
Auto-Buffer Recognition	Yes (COND 6+)
Hold Function	Yes "HO"
Low Battery Indicator	Yes "LO"
Salinity Conversion Factor	Non-linear Compensation (SALT 6+)
Auto Shut Off	20 minutes after last key operation
Display	Custom LCD
Operating Temperature	0 to 50 °C
Power Requirements	(4) AAA alkaline batteries (included)
Battery Life	>100 hours
Meter Dimensions / Weight	15.7 x 8.5 x 4.2 cm / 255 g

## 9. CONDUCTIVITY THEORY

Conductance is a quantity associated with the ability of primarily aqueous solutions to carry an electrical current,  $I$ , between two metallic electrodes when a voltage  $E$  is connected to them. Though water itself is a rather poor conductor of electricity, the presence of ions in the water increases its conductance considerably, the current being carried by the migration of the dissolved ions. This is a clear distinction from the conduction of current through metal, which results from electron transport.

The conductance of a solution is proportional to and a good, though non-specific indicator of the concentration of ionic species present, as well as their charge and mobility. It is intuitive that higher concentrations of ions in a liquid will conduct more current. Conductance derives from Ohms law,  $E = IR$ , and is defined as the reciprocal of the electrical resistance of a solution.

$$C = 1 / R$$

where  $C$  is conductance (siemens)  
 $R$  is resistance (ohms)

One can combine Ohms law with the definition of conductance, and the resulting relationship is:

$$C = I / E$$

where  $I$  is current (amps)  
 $E$  is potential (volts)

In practice, conductivity measurements involve determining the current through a small portion of solution between two parallel electrode plates when an AC voltage is applied. Conductivity values are related to the conductance (and thus the resistance) of a solution by the physical dimensions --- area and length --- or the cell constant of the measuring electrode. If the dimensions of the electrodes are such that the area of the parallel plates is very large, it is reasonable that more ions can reside between the plates, and more current can be measured. The physical distance between the plates is also critical, as it effects the strength of the electric field between the plates. If the plates are close and the electric field is strong, ions will reach the plates more quickly than if the plates are far apart and the electric field is weak. By using cells with defined plate areas and separation distances, it is possible to standardize or specify conductance measurements.



Thus derives the term specific conductance or conductivity.

The relationship between conductance and specific conductivity is:

$$\begin{aligned}\text{Specific Conductivity, S.C.} &= (\text{Conductance}) (\text{cell constant, } k) \\ &= \text{siemens} \cdot \text{cm/cm}^2 \\ &= \text{siemens/cm}\end{aligned}$$

where C is the conductance (siemens)  
k is the cell constant, length/area or cm/cm<sup>2</sup>

Since the basic unit of electrical resistance is the ohm, and conductance is the reciprocal of resistance, the basic unit of conductance was originally designated a “mho” – ohm spelled backwards – however, this term has been replaced by the term “Siemens”. Conductivity measurements are reported as Siemens/cm, since the value is measured between opposite faces of a cell of a known cubic configuration. With most aqueous solutions, conductivity quantities are most frequently measured in microSiemens per cm (µS/cm) or milliSiemens per cm (mS/cm).

The salinity value which ranges from 2 to 42 is a measure of all salts, not just sodium chloride. This scale was originally devised for seawater, and is based on seawater at 15 °C having a conductivity equivalent to that of a potassium chloride solution of a known concentration. This solution (0.44 molal) is defined as having a salinity of 35 ppt.

The total dissolved solids scale approximates the ppm TDS in surface waters by multiplying the conductivity of a sample by a factor, 0.66.

Some users prefer the use of resistivity units to describe their water, particularly where high purity water is involved. The unit most often used to describe resistivity is megohm-cm, which are simply the reciprocal of conductivity (µS/cm). The chart below shows the relationship between these units.

<b>Conductivity (µS/cm)</b>	<b>Resistivity (megOhm-cm)</b>
0.056	18
0.1	10
1.0	1.0
2.5	0.4
10.0	0.1

## Conductivity and Temperature

Conductivity in aqueous solutions reflects the concentration, mobility, and charge of the ions in solution. The conductivity of a solution will increase with increasing temperature, as many phenomena influencing conductivity such as solution viscosity are affected by temperature.

The relationship between conductivity and temperature is predictable and usually expressed as relative % change per degree centigrade. This temperature coefficient (% change per degree) depends on the composition of the solution being measured. However, for most medium range salt concentration in water, 2% per degree works well. Extremely pure water exhibits a temperature coefficient of 5.2%, and concentrated salt solutions about 1.5%.

Since temperature affects the conductivity measurement so profoundly, usual practice is to reference the conductivity to a standard temperature — typically 25 °C. Select 20 °C or 25 °C as the normalization temperature in advanced setup.

Enter the temperature coefficient which best suits your sample and use an ATC probe to automatically temperature compensate back to the chosen reference temperature.

## 10. CALIBRATION TIPS

You only need one calibration for measurement throughout the entire range of the meter. If a range was not calibrated, the meter automatically detects the closest range calibrated and uses that calibration information. However, only the ranges that were calibrated have maximum accuracy.

If you are measuring in ranges near to or greater than 20 mS/cm (10 ppt), or near to or lower than 100  $\mu$ S/cm (50 ppm), suggested calibration frequency is at least weekly.

If you are measuring in the mid-ranges and you wash the probe in deionized water and store it dry, suggested calibration frequency is at least monthly.

Wet the probe for 10 minutes before calibrating or taking readings to saturate the probe surface and minimize drift. If you take measurements at extreme temperatures, calibrate the meter at least once a week.

You should only use the probe specified for these meters. These probes have a built-in temperature sensor. If you use a different probe without a temperature sensor, you must measure the solution temperature separately and manually enter the solution temperature.

## 11. CALCULATING TDS CONVERSION FACTOR

You can calibrate your meter using TDS calibration standard solutions. The calibration standard only needs to give the TDS value at a standard temperature such as 25 °C. To determine the conductivity-to-TDS conversion factor use the following formula:

$$\text{Factor} = \text{Actual TDS} \div \text{Actual Conductivity @ 25 }^{\circ}\text{C}$$

**Actual TDS:** Value from the solution bottle label or as a standard you make using high purity water and precisely weighed salts.

**Tip:** ppm = milligram of salt(s) per liter of water

**Actual Conductivity:** Value measured using a properly calibrated Conductivity/Temperature meter.

Both the Actual TDS and the Actual Conductivity values must be in the same magnitude of units. For example, if the TDS value is in ppm the conductivity value must be in  $\mu\text{S}/\text{cm}$ ; if the TDS value is in ppt the conductivity value must be in  $\text{mS}/\text{cm}$ .

Check your factor by multiplying the conductivity reading by the factor in the above formula. The result should be in TDS value.

**Tip:** When the TDS factor is set to 1.0, Conductivity = TDS.

## 12. CALCULATING TEMPERATURE COEFFICIENTS

To determine the temperature coefficient of your sample solution use this formula:

$$t_c = 100 \times \frac{C_{T_2} - C_{T_1}}{C_{T_1}(T_2 - 25) - C_{T_2}(T_1 - 25)}$$

Where:

$t_c$  = Temperature coefficient

25 = 25 °C

$C_{T_1}$  = Conductivity at Temp 1

$C_{T_2}$  = Conductivity at Temp 2

$T_1$  = Temp 1

$T_2$  = Temp 2

**NOTE:** A controlled temperature water bath is ideal for this procedure.

1. Immerse the probe into a sample of your solution and adjust the temperature coefficient to 0% (that is, no compensation) by following instructions as described in *Section 6.5 – Temperature Coefficient*.
2. Wait for 5 minutes. Note  $T_1$  and  $C_{T_1}$  (conductivity at  $T_1$ ).
3. Condition the sample solution and probe to a temperature ( $T_2$ ) that is about 5 °C to 10 °C different from  $T_1$ , and note the conductivity reading  $C_{T_2}$ .

**NOTE:** Record your results for future reference. Ideally  $T_1$  and  $T_2$  should bracket your measurement temperature, and should not differ by more than 5 °C.

4. Calculate the temperature coefficient of your solution according to the formula shown above.
5. Enter the calculated temperature coefficient into the meter.

See *Section 5.5 – Temperature Coefficient*.

The calculated temperature coefficient will now be applied to all the meter readings.

## 13. REPLACEMENTS AND ACCESSORIES

Item Description	Part Number Ordering Code	
	Eutech	Oakton
COND 6+ meter with probe	ECCON603PLUS	35604-00
COND 6+ kit. Meter and probe in hard carry case with bottles of	ECCON603PLUSK	35604-04
TDS 6+ meter only and probe	ECTDS603PLUS	35604-20
TDS 6+ kit. Meter and probe in hard carry case with bottles of	ECTDS603PLUSK	35604-24
SALT 6+ meter only and probe	ECSALT603PLUS	35604-40
SALT 6+ kit. Meter and probe in hard carry case with bottles of	ECTDS603PLUSK	35604-44
Replacement electrode with BNC & ATC plug, k = 1.0, 1 m cable	ECCONSEN91B	35606-55
Hard carry case with empty bottles	ECECODRY-KIT	35632-97
Conductivity probe, K = 0.1	ECCONSEN72B	35606-53
Conductivity probe, K = 10	-	35606-57
Deionized rinse water, (20) x 20 mL sachets	-	35653-00
10 µS/cm conductivity standard solution, (20) x 20 mL sachets	ECCON10BS	35653-09
23 µS/cm conductivity standard solution, 480 mL bottle	-	00653-23
84 µS/cm conductivity standard solution, 480 mL bottle	ECCON84BT	00653-16
100 µS/cm conductivity standard solution, 480 mL bottle	ECCON100BT	-
447 µS/cm conductivity standard solution, (20) x 20 mL sachets	ECCON447BS	35653-10
447 µS/cm conductivity standard solution, 480 mL bottle	-	00653-47
500 µS/cm conductivity standard solution, 480 mL bottle	ECCON500BT	-
1413 µS/cm conductivity standard solution, (20) x 20 mL sachets	ECCON1413BS	35653-11
1413 µS/cm conductivity standard solution, 480 mL bottle	ECCON1413BT	00653-18
1500 µS/cm conductivity standard solution, 480 mL bottle	-	00653-15
2070 µS/cm conductivity standard solution, 480 mL bottle	-	00653-27
2764 µS/cm conductivity standard solution, (20) x 20 mL sachets	ECCON2764BS	35653-12
2764 µS/cm conductivity standard solution, 480 mL bottle	ECCON2764BT	00653-20
5.0 mS/cm conductivity standard solution, 480 mL bottle	ECCON5000BT	-
5650 µS/cm conductivity standard solution, 480 mL bottle	-	35653-15
8974 µS/cm conductivity standard solution, 480 mL bottle	-	00653-89
12880 µS/cm conductivity standard solution, 480 mL bottle	ECCON1288BT	00606-10
15000 µS/cm conductivity standard solution, (20) x 20 mL sachets	ECCON15000BS	35653-13
15000 µS/cm conductivity standard solution, 480 mL bottle	-	00653-50
111.8 mS/cm conductivity standard solution, 480 mL bottle	ECCON1118BT	-
80 mS/cm conductivity standard solution, 480 mL bottle	-	00653-32
50 ppm TDS 442 standard solution, 480 mL bottle	EC44250BT	-
300 ppm TDS 442 standard solution, 480 mL bottle	EC442300BT	-
1000 ppm TDS 442 standard solution, (20) x 20 mL sachets	-	35653-11
1000 ppm TDS 442 standard solution, 480 mL bottle	EC4421000BT	00653-18
3000 ppm TDS 442 standard solution, 480 mL bottle	EC4423000BT	-
3 ppt salinity (NaCl) standard solution, (20) x 20 mL sachets	-	35653-15
5 ppt salinity (NaCl) standard solution, 480 mL bottle	ECNACL5PPT	-
25 ppt salinity (NaCl) standard solution, 480 mL bottle	ECNACL25PPT	-
45 ppt salinity (NaCl) standard solution, 480 mL bottle	ECNACL45PPT	-

## 14. WARRANTY

This meter is supplied with a warranty against significant deviations in material and workmanship for a period of **THREE** years from date of purchase whereas probe with a **SIX**-month warranty.

If repair or adjustment is necessary and has not been the result of abuse or misuse within the designated period, please return – freight pre-paid – and correction will be made without charge. Eutech Instruments will determine if the product problem is due to deviations or customer misuse.

Out of warranty products will be repaired on a charged basis.

### Exclusions

The warranty on your instrument shall not apply to defects resulting from:

- Improper or inadequate maintenance by customer
- Unauthorized modification or misuse
- Operation outside of the environment specifications of the products

## 15. RETURN OF ITEMS

Authorization must be obtained from our Customer Service Department or authorized distributor before returning items for any reason. A "Return Goods Authorization" (RGA) form is available through our authorized distributor. Please include data regarding the reason the items are to be returned. For your protection, items must be carefully packed to prevent damage in shipment and insured against possible damage or loss. Eutech Instruments will not be responsible for damage resulting from careless or insufficient packing. A restocking charge will be made on all unauthorized returns.

NOTE: Eutech Instruments Pte Ltd /Oakton Instruments reserve the right to make improvements in design, construction, and appearance of products without notice.



**For more information on our products, please contact our channel partner or visit our websites listed below:**

**Oakton Instruments**

625 E Bunker Court  
Vernon Hills, IL 60061  
USA

Tel: (1) 888-462-5866

Fax: (1) 847-247-2984

[info@4oakton.com](mailto:info@4oakton.com)

[www.4oakton.com](http://www.4oakton.com)

**Eutech Instruments Pte Ltd**

Blk 55, Ayer Rajah Crescent,  
#04-16/24

Singapore 139949

Tel: (65) 6778 6876

Fax: (65) 6773 0836

[eutech@thermofisher.com](mailto:eutech@thermofisher.com)

[www.eutechinst.com](http://www.eutechinst.com)

**Distributed by:**