

## Maintenance, Recalibration, and Repair

### Cleaning and storage

The instrument should be cleaned with a damp cloth and mild detergent when necessary. Do not use solvents or abrasives.

Store the instrument in an area with moderate temperature and humidity.

It is recommended that Traceable products are calibrated annually to ensure proper function and accurate measurements; however, your quality system or regulatory body may require more frequent calibrations.

## User Manual

# Traceable®

## Temperature/RH Touch-Screen Monitor

with NIST-Traceable Calibration

### Model 20250-40

### WARRANTY, SERVICE, OR RECALIBRATION

For warranty, service, or recalibration, contact:

**TRACEABLE® PRODUCTS**  
12554 Old Galveston Rd. Suite B230  
Webster, Texas 77598 USA  
Ph. 281 482-1714 • Fax 281 482-9448  
E-mail [support@traceable.com](mailto:support@traceable.com)  
[www.traceable.com](http://www.traceable.com)

Traceable® Products are ISO 9001:2015 Quality-Certified by DNV and ISO/IEC 17025:2017 accredited as a Calibration Laboratory by A2LA.



## Unpacking

Check individual parts against the list of items below. If anything is missing or damaged, please contact your instrument supplier immediately.

1. Touch-screen monitor tablet
2. Temperature/RH sensor
3. Sensor extension cable, 6-ft (1.8m) long
4. Wall-mounting bracket
5. USB cable
6. Power supply
7. NIST-traceable calibration report with data

## Specifications

Humidity range and accuracy	20 to 80%rh, $\pm 2\%$ rh at 25°C
	10%rh to 20%rh & 80%rh to 95%rh, $\pm 2.5\%$ rh
Temperature range	14 to 176°F (-10 to 80°C) for sensor probe
Temperature accuracy	$\pm 0.9^\circ\text{F}$ ( $\pm 0.5^\circ\text{C}$ )
Dew point temperature range	-4 to 176°F (-20 to 80°C)
Internal storage	16GB
Dimension (W X H X D)	75/8" X 41/4" X 5/8" (19.4 X 10.8 X 1.6cm)
Adapter	5V 2A AC adapter with universal heads
Battery	3000mAh lithium battery
Operation temperature	-4 to 176°F (-10 to 80°C) for sensor probe
	14 to 104°F (-10 to 40°C) for Tablet
Storage temperature	14 to 104°F (-10 to 40°C)

**Info:** Show version information and upgrade software.

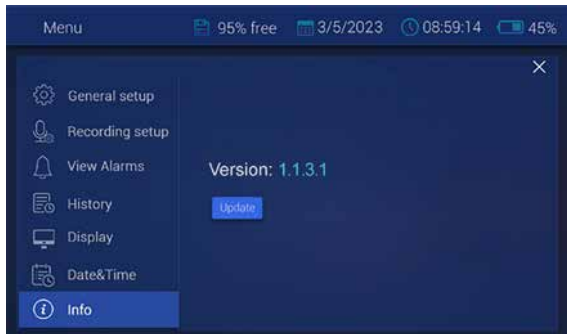

1. Version: indicates the current software version.
2. Click on Update to upload free future software updates over the life of the product.
3. Click "X" to return to main interface.

**Note:** Future software updates can be easily installed from your computer as follows:

1. Connect the instrument to your computer via the USB cable provided.
2. Copy the latest downloaded software file from your computer to the root directory of the instrument.
3. Click "Update" to realize upgrade

## Description

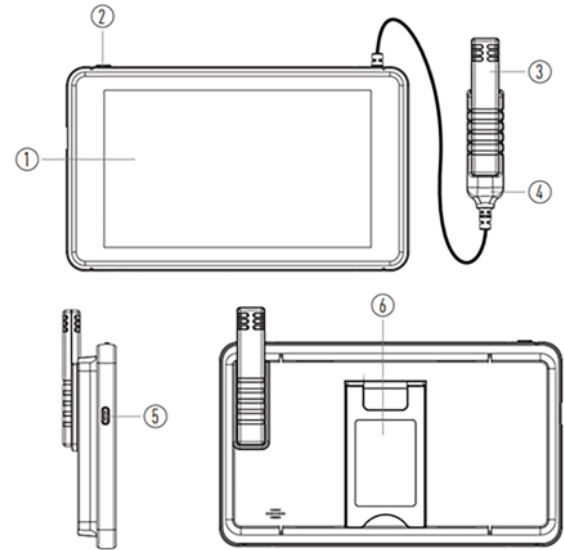

1. Touch-screen monitor tablet
2. On/Off button
3. Temperature/RH sensor
4. Slot for short probe
5. USB interface for charging power and reviewing data via PC
6. Built-in desk stand and wall-mounting bracket

**NOTE:** Before turning on the datalogger, please insert the probe (shown as above **3**) into the probe socket (shown as above **4**) of the extension cable or the socket at the back of the datalogger first, and then press the On/Off button **2** to turn it on.

## Key Features

- High accuracy measurement
- Graphical and digital touch screen display interface
- Multifunction content-rich interactive menu
- Large high-resolution color LCD, resolution 1024 x 600
- Touch-screen operation
- Live and future recording options
- User-adjustable high and low alarms, sampling rates, and data points
- Live and future recording options
- Selectable temperature units (°F/°C)
- Max/Min readings
- Date and time setting
- Adjustable brightness and screen saver timing
- Export the recording data to computer
- Built-in desktop stand and wall-mounting bracket options

## Applications

- Food processing
- Environmental monitoring
- Health care
- Storage and warehouse monitoring
- Office and workspace monitoring

## Date & Time

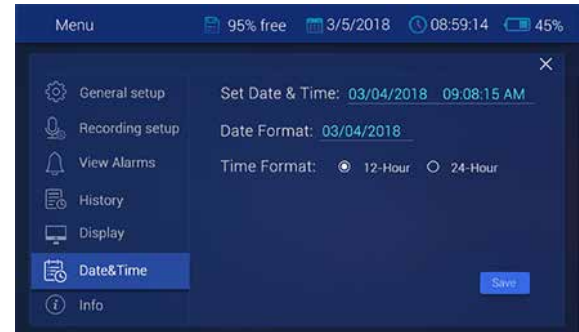

1. Click on the current date and time to open the dialogue, then scroll the numbers up and down to set the correct date and time.
2. Click on the current date format to select the one needed.
3. Time format: select 12 hour or 24 hours format.

## Saved Excel Files

An Excel file is generated automatically when placed in Recording Mode. It can be reviewed when connected to the computer.

Connect the instrument to the computer via USB cable, the path for the saved data is This PC\91-9012-00\Internal shared storage\RH-T data.

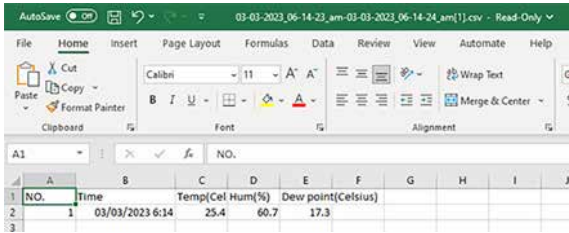

**Display:** allows you to adjust the brightness, screen saver mode, turn on screen saver timing, sleep mode and turn off display timing.

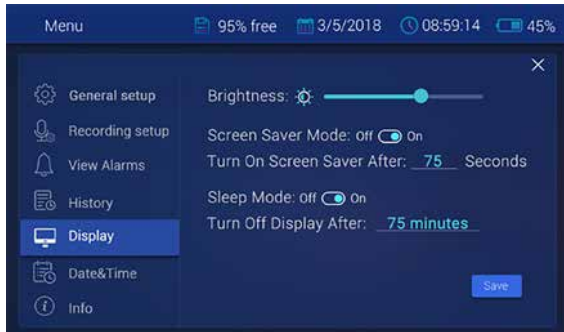

1. Brightness: drag the dot to adjust the screen brightness level.
2. Screen saver mode: use to set the screen save mode On or off. Turn on screen saver after: use to set the automatic screen saver time, active only after turn on the screen saver mode.
3. Sleep Mode: use to set the sleep mode On or off. Turn off display after: use to set the automatic sleep mode time, active only after turn on the sleep mode.
4. Click "Save" to save setting parameter.

## Setup and Operation

**Caution:** The sensor or sensor extension cable should be connected to the instrument before turning it on to prevent data corruption.

## Main Interface

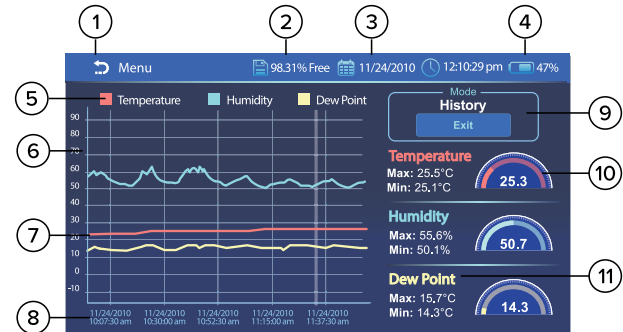

1. Menu function
2. Memory display icon, "Free" indicating the remaining memory
3. System real time
4. Battery capacity
5. Boxes toggle Temperature, Humidity and Dew Point readings in curve chart.
6. Numerical scale of the temperature, humidity, and dew point
7. Three curves represent trend of temperature, humidity, and dew point.
8. Numerical scale of date and time
9. Mode, start/stop recording.
10. Value of real-time temperature, humidity, and dew point
11. Max/Min

## Screen Display Switch Function

Screen will switch from main screen to a better HD view automatically as shown below after 1 minute of not using.



Screen will switch back to the main display by responding to the touch.

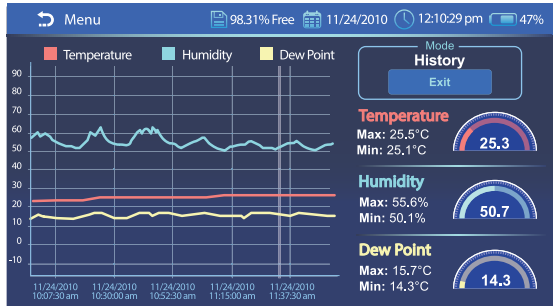

## History

Click **History** button on Menu screen to pull up a menu of recorded files as shown below.

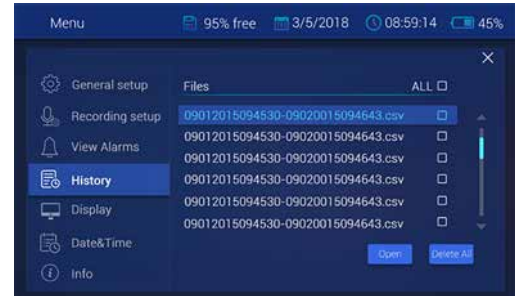

1. Click All check to select/deselect all files to delete.
2. Click the check/checks to select a file, several, or all files to delete.
3. Click the check of file that you want to open, click on this file, a dialogue will pop out for open or cancel open. If open is selected, the screen will switch to the main screen to show the graph and data as below.
4. Click any point on the curve to see the data at that point.
5. Click "Exit" to exit History mode and return to main interface.

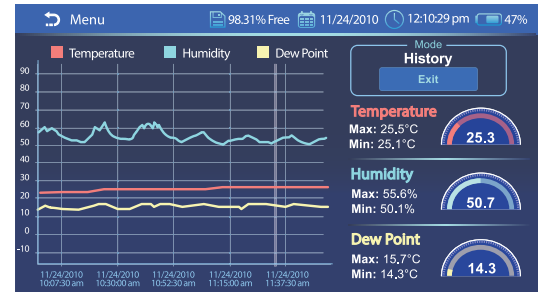

**Recording setup:** Allows you to set sampling rate, schedule recording, start time and data points.



1. Sample rate: set samples rate.
2. Schedule Recording: off/on
3. Start Time: Set recording starting time (Note: The default time is the current date and time in the system; a start time can be set into the future and the instrument will be automatically start recording at the future date and time.)
4. Max Data Points: set the number of sample points from 500, 1000, 5000, 10000, 20000 and MAX.
5. Click "Save" to save setting parameter.
6. Click X to cancel the change and back to the main screen.

**View Alarms:** Lets you view recorded alarm values.



1. Sort by date: view recorded alarms sorted by date.
2. Sort by value: view recorded sorted by temperature and humidity alarm value.

**Chart Area**

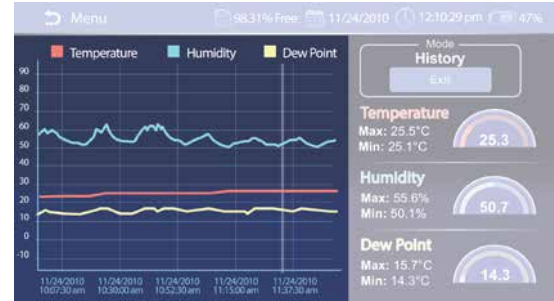

1. Red curve shows trend of temperature.
2. Green curve shows trend of humidity.
3. Yellow curve shows trend of dew point.
4. Vertical y-axis represents the value of temperature, humidity and dew point.
5. Horizontal x-axis represents the date and time.
6. When the curve area is touched, there will be line there and the number values of temperature, humidity and dew point values at that line will be shown on the right curve areas.

## Digital area

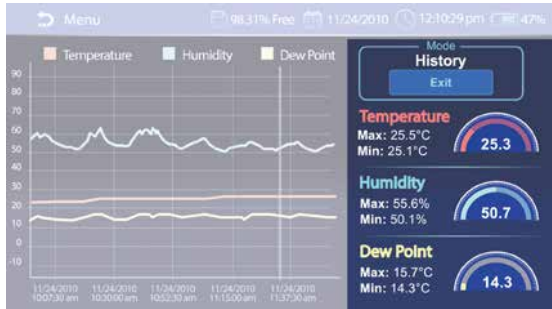

1. "Temperature" circle and value
2. "Humidity" circle and value
3. "Dew Point" circle and value
4. The alarm icon will flash with sound when the temperature and humidity alarm is triggered
5. Click on the circle of Temp/RH/Dew, the display will switch to the HD view as shown below:



## Menu

Click the Menu button on main screen brings up the menu below which allows you to set various parameters.



**General setup:** Allows you to set temperature units and temperature / humidity alarm levels.



1. Temperature Unit: switch between units (°F/°C)
2. Alarm: check the box to set alarm values of the temperature and humidity.
3. Click "Save" to save the settings.
4. Click X to exit.