

■ SINGLE-PHASE
POWER QUALITY ANALYZER

8220



Statement of Compliance

Chauvin Arnoux®, Inc. d.b.a. AEMC® Instruments certifies that this instrument has been calibrated using standards and instruments traceable to international standards.

We guarantee that at the time of shipping your instrument has met its published specifications.

An NIST traceable certificate may be requested at the time of purchase, or obtained by returning the instrument to our repair and calibration facility, for a nominal charge.

The recommended calibration interval for this instrument is 12 months and begins on the date of receipt by the customer. For recalibration, please use our calibration services. Refer to our repair and calibration section at www.aemc.com.

Serial #: _____

Catalog #: _____

Model #: 8220 & 8220 Kits

Please fill in the appropriate date as indicated:







Date Received: _____

Date Calibration Due: _____



Chauvin Arnoux®, Inc.
d.b.a AEMC® Instruments
www.aemc.com

Table of Contents

1. INTRODUCTION.....	4
1.1 International Electrical Symbols.....	4
1.2 Definition of Measurement Categories.....	5
1.3 Receiving Your Shipment.....	5
1.4 Ordering Information.....	5
1.4.1 Accessories and Replacement Parts.....	6
1.4.2 Third Party Accessories.....	6
2. PRODUCT FEATURES	7
2.1 Description.....	7
2.2 Control Features.....	8
2.3 Display.....	11
2.4 Power Supply.....	13
2.5 Optically Coupled USB Interface.....	13
2.6 Button Functions.....	13
2.6.1 Photograph Button 	13
2.6.2 View Button 	14
2.6.3 Delete Button 	15
2.6.4 Print Button 	16
2.6.5 ◀▶ Buttons.....	16
2.6.6 White Button 	17
2.6.7 Yellow Button 	17
3. SPECIFICATIONS.....	18
3.1 Reference Conditions.....	18
3.2 Electrical Specifications.....	18
3.2.1 Voltage Inputs.....	18
3.2.2 Current Inputs.....	19
3.2.3 Bandwidth.....	19

3.2.4	Power Supply.....	20
3.2.5	Accuracy Specifications (excluding current probes)	21
3.2.6	Accuracy Specifications of the Current Probes	23
3.2.7	Current Probes and Sensors	24
3.3	Mechanical Specifications.....	25
3.4	Environmental Specifications.....	26
3.5	Safety Specifications.....	26
4.	OPERATION	27
4.1	General Operating Instructions.....	27
4.2	Connecting the Cables.....	28
4.2.1	Single-phase Network.....	28
4.2.2	Balanced Three-phase Network	28
4.3	Using the 5A Adapter / MN193 5A Current Probe	29
4.4	Automatic Shut-off.....	29
4.5	Instrument Configuration	30
4.6	Rotary Switch Modes	35
4.6.1	Voltage and Current	35
4.6.2	Power and Three-Phase Calculations	37
4.6.3	Voltage and Current Harmonics	41
4.6.4	Inrush and Phase Rotation	43
4.6.5	Rotation Speed (RPM)	46
4.6.6	Temperature and Resistance	46
5.	DATAVIEW® SOFTWARE	47
5.1	Installing DataView®.....	47
5.2	Connecting the Model 8220 to your Computer	50
5.3	Opening the Control Panel.....	51
5.4.1	Common Functions.....	52
5.4.2	Instrument Configuration.....	52
5.4.3	Inrush and RPM Configuration.....	54
5.5	Real-time Windows	55
5.5.1	Waveform, Harmonic Bar and Harmonic Text.....	55
5.5.2	Power/Energy	56
5.5.3	Trend.....	57

5.6	Downloading Data to Database	57
5.7	Saving Real-time Measurements	58
6.	MAINTENANCE	60
6.1	Changing the Batteries.....	60
6.2	Recharging the Rechargeable Batteries	61
6.3	Cleaning.....	61
APPENDIX A:	Mathematical Formulas	62
	Half-period Voltage and Current RMS Values.....	62
	MIN / MAX Values for Voltage and Current.....	62
	Peak Voltage and Current.....	62
	Peak Factors for Current and Voltage.....	63
	1 sec RMS Values for Voltage and Current.....	63
	Harmonic Calculations	63
	Different Power Levels in Single-Phase Connection.....	64
	Different Power Levels in Balanced Three-Phase Connection	64
	Ratios	64
	K Factor.....	65
	Various Types of Energy	65
	Hysteresis	66
	Diagram of 4 Quadrants.....	67
	Saturation of Input Channels.....	67
	Repair and Calibration.....	68
	Technical and Sales Assistance	68
	Limited Warranty	69
	Warranty Repairs.....	69

INTRODUCTION



Warning



- Never use on circuits with a voltage higher than 600V and an overvoltage category higher than CAT III.
- Use in indoor environments only.
- Only use accessories that are compliant with the safety standards (IEC 664-1 Ed. 92) 600V CAT III or 300V CAT IV.
- Only use factory specified replacement parts.
- Always disconnect the power cord, measurement leads and sensors before replacing the battery.

1.1 International Electrical Symbols

	Signifies that the instrument is protected by double or reinforced insulation.
	CAUTION - DANGER! Read the User Manual.
	Risk of electric shock. The voltage at the parts marked with this symbol may be dangerous.
	Refers to a type A current sensor. This symbol signifies that application around and removal from HAZARDOUS LIVE conductors is permitted.
	Refers to a type B current sensor. Do not apply around or remove from HAZARDOUS LIVE conductors without additional protective means (de-energizing the circuit or wearing protective clothing suitable for high voltage work).
	Important instructions to read and understand completely.
	Important information to acknowledge.
	USB socket
	The CE marking guarantees conformity with European directives and with regulations covering EMC.
	The trash can with a line through it means that in the European Union, the product must undergo selective disposal for the recycling of electric and electronic material, in compliance with Directive WEEE 2002/96/EC.

1.2 Definition of Measurement Categories

- CAT I:** For measurements on circuits not directly connected to the AC supply wall outlet such as protected secondaries, signal level, and limited energy circuits.
- CAT II:** For measurements performed on circuits directly connected to the electrical distribution system. Examples are measurements on household appliances or portable tools.
- CAT III:** For measurements performed in the building installation at the distribution level such as on hardwired equipment in fixed installation and circuit breakers.
- CAT IV:** For measurements performed at the primary electrical supply (<1000V) such as on primary overcurrent protection devices, ripple control units, or meters.

1.3 Receiving Your Shipment

Make sure that the contents shipped are consistent with the packing list. Notify your distributor of any missing items. If the equipment appears to be damaged, file a claim immediately with the carrier and notify your distributor at once, giving a detailed description of any damage. Save the damaged packing container to substantiate your claim. Do not use equipment which is damaged or appears to be damaged.

1.4 Ordering Information

Model 8220 Cat. #2130.90

Includes set of two 10 ft (3m) color-coded leads (red/black) with alligator clips, set of safety test probes (red/black), optically isolated USB cable, set of six 1.5V AA batteries, DataView® software, carrying bag, product warranty card and user manual.

Model 8220 w/MN93-BK Cat. #2130.91

Includes the Model 8220, one MN93 (240A) current probe (black connector), set of two 10 ft (3m) color-coded leads (red/black) with alligator clips, set of safety test probes (red/black), optically isolated USB cable, set of six 1.5V AA batteries, DataView® software, carrying bag, product warranty card and user manual.

Model 8220 w/SR193-BK Cat. #2130.92

Includes the Model 8220, one SR193 (1200A) current probe (black connector), set of two 10 ft (3m) color-coded leads (red/black) with alligator clips, set of safety test probes (red/black), optically isolated USB cable, set of six 1.5V AA batteries, DataView® software, carrying bag, product warranty card and user manual.

Model 8220 w/24" AmpFlex® 193-24-BK Cat. #2130.93

Includes the Model 8220, one 24" AmpFlex® 193-24 (6500A) sensor (black connector), set of two 10 ft (3m) color-coded leads (red/black) with alligator clips, set of safety test probes (red/black), optically isolated USB cable, set of six 1.5V AA batteries, DataView® software, carrying bag, product warranty card and user manual.

Model 8220 w/MN193-BK Cat. #2130.96

Includes the Model 8220, one MN193 (6A/120A) current probe (black connector), set of two 10 ft (3m) color-coded leads (red/black) with alligator clips, set of safety test probes (red/black), optically isolated USB cable, set of six 1.5V AA batteries, DataView® software, carrying bag, product warranty card and user manual.

1.4.1 Accessories and Replacement Parts

AC/DC Current Probe Model SL261.....	Cat. #1201.51
Soft Carrying Pouch	Cat. #2119.48
Small Classic Carrying Bag.....	Cat. #2133.72
Optically Isolated USB Cable (RS-232 Connector).....	Cat. #2135.41
5A Adapter Box (for 1 or 5A probes).....	Cat. #2140.17
AC Current Probe Model MR193-BK (1000Aac/1400Adc)	Cat. #2140.28
Set of Two 10 ft Color-coded Leads with Alligator Clips.....	Cat. #2140.31
AC Current Probe Model MN93-BK (240A).....	Cat. #2140.32
AC Current Probe Model SR193-BK (1200A)	Cat. #2140.33
AmpFlex® Sensor 24" 193-24-BK (6500A)	Cat. #2140.34
AmpFlex® Sensor 36" 193-36-BK (6500A).....	Cat. #2140.35
AC Current Probe Model MN193-BK (6A/120A)	Cat. #2140.36
US 110V Power Adapter.....	Cat. #2140.37
220V Power Adapter.....	Cat. #2140.38
BNC Adaptor for use with SL261.....	Cat. #2140.40
MiniFlex® Sensor 10" Model MA193-10-BK.....	Cat. #2140.48

1.4.2 Third Party Accessories

Converter - Ethernet to RS-232, Model ESP901
Available Online..... www.bb-elec.com

Order Accessories and Replacement Parts Directly Online
Check our Storefront at www.aemc.com/store for availability

PRODUCT FEATURES

2.1 Description

The Model 8220 is a single-phase AC+DC power meter with an electroluminescent backlit digital display and is rated to 600V CAT III.

It is a measurement tool for electrical parameters and distribution network disturbances, enabling the user to obtain instant measurements of the main characteristics of a single-phase network (voltage, current, power, voltage and current harmonics, etc) and to monitor machinery in operation (temperature, inrush current and duration of operation, resistance of windings and rotational speed).

Compact and shock resistant, its ergonomic design and straightforward interface make it user-friendly and intuitive. Within seconds you will be gathering the measurements you want.

The Model 8220's accuracy is better than 1% (excluding current sensors). It has a great flexibility due to AEMC's range of current sensors, measuring from a few hundred milliamps to several thousand amps.

The Model 8220 is designed for technicians, control and maintenance engineers, as well as electrical contractors, inspectors and educators.



NOTE: The Model 8220 can be powered by 6 x AA batteries or a 110V/220V AC power adaptor (with batteries removed).

Features:

- Measures up to 660Vrms or VDC
- Measures up to 6500AAC or 1400ADC (probe dependent)
- Displays Min, Max and Average Volts and Amps, Crest Factor, Peak value and K-Factor
- Calculates and displays Watts, VARs and VA, Power Factor and Displacement Power Factor for single-phase and balanced three-phase
- Displays total harmonic distortion (THD-F and THD-R) for voltage and current
- Displays individual harmonic values and % for Volts and Amps through the 50th harmonic
- Captures and displays inrush current
- Calculates and displays phase rotation and RPM

- Displays resistance up to 200Ω
- Conducts continuity and diode tests
- Stores up to nine complete sets of readings for all volt, amp, power and harmonic measurements (photograph mode)
- Configurable from DataView® software or front panel
- Download stored data to DataView® software via optical USB port
- Includes DataView® software FREE for data storage, real-time waveform display, analysis and report generation

2.2 Control Features

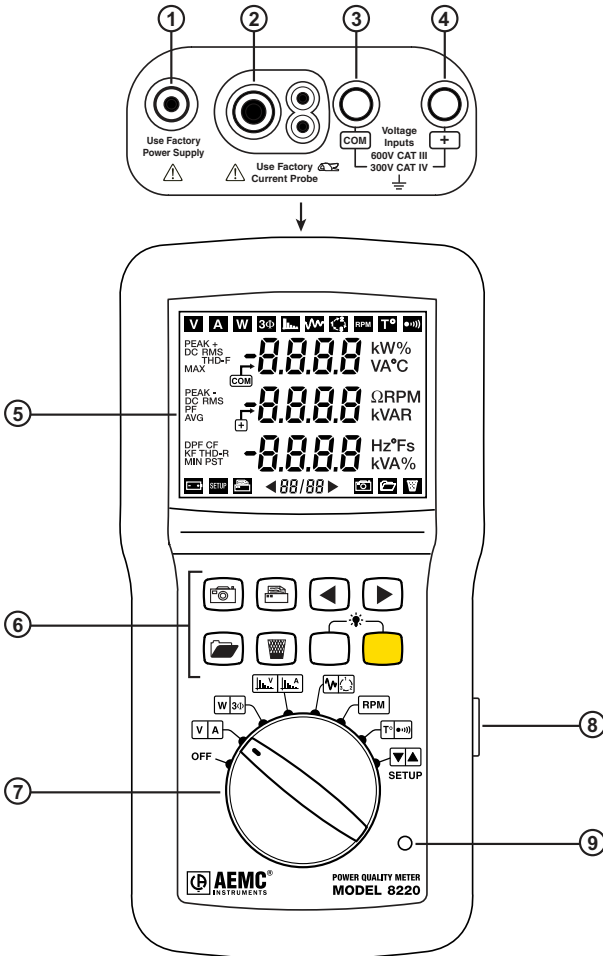



















Figure 2-1

ITEM	FUNCTION
1.	External power supply jack
2.	Four-pin input for current sensor (MN, SR, AmpFlex, etc.)
3.	Negative terminal
4.	Positive terminal
5.	Electroluminescent backlit digital display
6.	Function Buttons:
	 Photograph Button Photographs measurements, viewable by pressing the View or Print buttons.
	 Print Button Prints all measurements currently displayed on an external printer.
	 Left Arrow Button Selects the previous page, returns to previous step or (if only one page) selects the value.
	 Right Arrow Button Selects the following page, advances to the next step or (if only one page) selects the value.
	 View Button Views saved screen photographs.
	 Delete Button Deletes one or all of the saved photographs or re-initializes the effective maximum and minimum half-cycle values in Inrush mode.
	 White Button Accesses voltage, power, voltage harmonic, motor start current, rotation speed, temperature and information modes and reduces the value in the configuration mode.
	 Yellow Button Accesses the current, balanced three-phase, current harmonic, phase rotation and resistance modes, reduces the value in the configuration mode. Also inhibits automatic extinction.
	 NOTE: For detailed information on these buttons, see § 2.6

7.	<p>Rotary Functions:</p> <hr/> <p> NOTE: To access the second function of a rotary position, turn the switch to the desired position then press the Yellow button.</p> <hr/> <p>OFF Turns the Instrument OFF</p> <hr/> <p> Voltage and Current modes</p> <hr/> <p> Power and Balanced Three-phase modes</p> <hr/> <p> Voltage and Current Harmonics modes</p> <hr/> <p> Inrush (motor start) and Phase Rotation modes</p> <hr/> <p> Rotation speed mode</p> <hr/> <p> Temperature and Resistance modes</p> <hr/> <p> Configuration mode</p> <hr/> <p> NOTE: For detailed information on these modes, see § 4.6.</p> <hr/>
8.	Infrared optically coupled interface for USB cable.
9.	<p>Light indicator:</p> <p>ON - indicates the 8220 is running on the optional external power supply.</p> <p>OFF - indicates the 8220 is running on the internal batteries.</p> <hr/>

2.3 Display

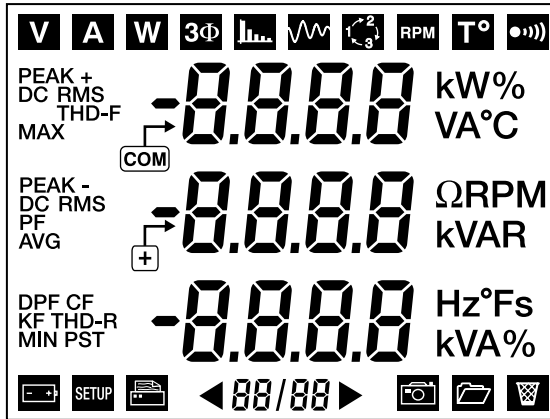

Figure 2-2

Pressing the White and Yellow buttons simultaneously toggles the backlight ON and OFF.

The display uses the following icons and abbreviations:

ICON	DESCRIPTION
	Voltage measurement
	Current measurement
	Power measurement (active, reactive, apparent)
	Calculation associated with connection to a balanced activated three phase network
	Voltage or current harmonics measurement
	Motor starting (<i>inrush</i>) measurement
	Phase rotation
	Rotation speed measurement
	Temperature measurement
	Resistance measurement (up to 2000Ω)
	When displayed, indicates the battery is low
	Flashes during data transfer of information to the external printer

	Number of active pages compared with total number of pages in the multiple pages modes
	Flashes while measurements are being captured
	Recalls a list of saved photographs; views a photograph
	Deletion of one or all of the photographs. Re-initialization of effective values during half-period of voltage or current.
%	Percentage
Ω	Resistance in ohms
$^{\circ}\text{C}$	Temperature in degrees Celsius
$^{\circ}\text{F}$	Temperature in degrees Fahrenheit
A	Current in amperes
AVG	Real RMS value of the signal calculated over one second
CF	Crest Factor (current or voltage)
DC	Continuous current and voltage component
DPF	Displacement Factor (cosine of Φ)
Hz	Network frequency in hertz
k	Kilo (10^3)
KF	K Factor (for transformers)
MAX	Maximum RMS half-cycle voltage or current value
MIN	Minimum RMS half-cycle voltage or current value
PEAK	Instantaneous maximum (+) or minimum (-) crest value of signal measured
PF	Power Factor (ratio of active power on the apparent power)
RMS	Real effective value (voltage or current)
RPM	Rotation speed in revolutions per minute (rotation per minute)
s	Duration in seconds
THD-F	Total Harmonic Distortion (or THD)
THD-R	Distortion Factor (or DF)
V	Voltage in volts
VA	Apparent Power (total if 3Φ)
VAR	Reactive Power (total if 3Φ)
W	Active Power (total if 3Φ)

2.4 Power Supply

The Model 8220 is powered by six 1.5V AA (LR6) alkaline batteries (standard or rechargeable). See § 6 for information on changing and recharging the batteries.

Battery life is dependent on type of battery:

Type of power supply	Back-lighting	
	Without	With
AA batteries	> 40 hours	> 20 hours
NiMH 1800mAh accumulators	> 30 hours	> 16 hours
NiCd 900mAh accumulators	> 15 hours	> 8 hours

Low Battery Indication Level:

Level 1 - The  symbol will flash once per second when the battery voltage is weak, but the instrument can still be used.

Level 2 - The  symbol flashes once per second. In addition, every 10 seconds (and repeated 7 times for a whole minute) a beeping sound is emitted together with the message “batt” displayed on the screen. After one minute, the instrument turns itself off.



2.5 Optically Coupled USB Interface

The optically coupled interface (Figure 2-1, item 8) provides an isolated, two-way connection between the Model 8220 and a PC for transmission of the information in memory (photographs, motor starts, records) and all instantaneous measurements and photographs displayed on the screen of the Model 8220.

The transfer rate is determined automatically by the Model 8220 according to the software used; the maximum rate is 115.2 kbps.

2.6 Button Functions

2.6.1 Photograph Button

This button photographs all the measurement pages displayed in the following rotary switch positions: , , .

When the  button is pressed, all the pages in the voltage, current, power, voltage harmonics and current harmonics modes are photographed and the next screen is displayed.

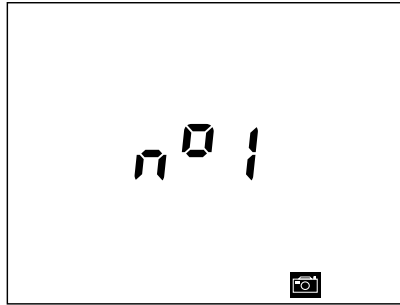



Figure 2-3
Example of a photograph number.

This screen displays the number of the photograph in which the pages have been stored. The photograph number flashes during the storage process and the  icon is displayed.





NOTE: If the memory used for storing the photographs is full, the message *MEM FULL* (Memory full) message is displayed.





2.6.2 View Button

This button first gives access to the list of photographs, then enables the user to select a photograph to be viewed.

To Display a List of Photographs:

Press the  button. A number of a photograph in the list will be displayed. Use the   buttons to:

- Display the number of a specific photograph to be viewed (see illustration above).
- Select *ALL* to select all photographs.

This list can be exited by pressing either the White or Yellow button ( ) or the  or  button, or by changing the position of the switch.







If the Model 8220 memory does not contain any photographs, *no REC* is displayed on the screen. The instrument then automatically returns to the preview mode.

To Display Pages of a Photograph:

After selecting the pages of a photograph as previously described, press the  button.

During the time that the photograph is being viewed, the  icon flashes in the bottom right-hand corner of the display.

To view the different pages:

- Select a function - ,  or  on the rotary switch.
- Use the white and yellow buttons ( ) to select a mode.
- Use the   buttons to navigate around the different pages of the selected mode.

To return to the list of photographs, press the  button again.

2.6.3 Delete Button

This button is used to delete one or all of the previously saved photographs.

To Delete a Photograph:

Press the  button to view the list of photographs.

Use the   buttons to:

- Display the number of a specific photograph to be deleted (see illustration on previous page).
- Select **ALL** to select all photographs.





Press the  button to delete the selected photograph.



WARNING: Selecting **ALL** will delete all saved photographs.

After deleting a specific photograph, one of the numbers of the remaining photographs is displayed.

If the list does not contain any further photos, the display indicates **no REC** (no recording). The display then switches automatically to a measurement mode.

This list can be exited by pressing either the White or Yellow button ( ) or the  or  button, or by changing the position of the switch.

If **ALL** was selected, **no REC** is displayed on the screen. The display then automatically switches to a measurement mode.

2.6.4 Print Button

Before using this button, an external serial printer must be connected to the Model 8220 using the specific serial cable provided with the printer.



NOTE: Do not use the optical USB cable provided with the instrument, to connect to the printer. Use the serial cable provided with the printer.

Pressing this button prints out all the information and measurements relating to the currently selected mode.



NOTE: It is not possible to print while viewing a photograph.

When data is transmitting, the  icon flashes.







Example of a print out when the rotary switch is turned to the  voltage mode:

```
*****  
Mode:voltage  
Vrms(V) = 225.7  
Arms(A) = 112.8  
Freq(Hz) = 50.00  
Vdc(V) = 3.2  
CF= 1.41  
Vmax(V) = 229.4  
Vmin(V) = 222.6  
Vpeak+(V) = 319.6  
Vpeak-(V) = -313.3
```

Figure 2-4







2.6.5 ◀▶ Buttons

These buttons enable the user to:

- Navigate between pages for the , ,  and  modes.
- Activate or de-activate the balanced three-phase mode for the  mode.
- Select the step in the  modes.







2.6.6 White Button

This button enables:

- Selection of the first function of each mode, indicated by the white markings around the rotary switch (, , , , ).
- Decreasing the values in the  SETUP mode.
- Exiting the list of photographs.
- Display of the information relating to the 8220 (serial, software and hardware numbers). This information is accessed by pressing and holding down the white button when turning the rotary switch from OFF to any other position.

2.6.7 Yellow Button

This button enables:

- Selection of the second function of each mode, indicated by the yellow markings around the rotary switch (, , , , ).
- Increasing the values in the  SETUP mode.
- Exiting the list of photographs.
- De-activation of the automatic shut-off (see § 4.4).

SPECIFICATIONS





3.1 Reference Conditions

Parameter	Reference Conditions
Ambient temperature	73° ± 5°F (23° ± 3°C)
Humidity	45 to 75%
Atmospheric pressure	25.4" Hg to 31.3" Hg (860 to 1060 hPa)
Phase-to-earth voltage	50 to 600Vrms without DC (< 0.5%)
Clamp current circuit input voltage	30mVrms to 1Vrms without DC (<0.5%)
AmpFlex® current circuit input voltage	11.8 to 118mVrms without DC (<0.5%)
Network frequency	50 and 60Hz ± 0.1Hz
Phase shift	0° active power / 90° reactive power
Harmonics	<0.1%
Balanced three-phase connection	Deactivated (OFF)

**All specifications are subject to change without notice.*

3.2 Electrical Specifications

3.2.1 Voltage Inputs

Switch Positions:     

Operating Range:

Phase-Phase - 0 to 660Vrms AC/DC*

Phase-Neutral - 0 to 600Vrms AC/DC

**Provided that the max with 600Vrms in regards to earth is not exceeded.*

Input Impedance: 451kΩ

Overload:

1.2Vn permanently; 2Vn for 1 sec (Vn = nominal voltage)

Switch Position: 

Input Impedance: 450k Ω

Overload: 600Vrms continuous

Switch Position: 

Voltage in Open Circuit: $\leq 4.6V$

Measurement Current: 500 μA

Overload: 600Vrms continuous

Threshold for Buzzer: 20 Ω (by default)

3.2.2 Current Inputs

Operating Range: 0 to 1V

Input Impedance:

1M Ω for current probe circuit and 12.4k Ω for AmpFlex[®] circuit

Overload: 1.7V

3.2.3 Bandwidth

Measurement Channels:

256 points per period, or:

- For 50Hz: 6.4kHz (256 \times 50 \div 2)
- For 60Hz: 7.68kHz (256 \times 60 \div 2)

Analog to -3dB: > to 10kHz

3.2.4 Power Supply

Power Source

Battery:	<ul style="list-style-type: none"> 6 standard batteries provided (non-rechargeable) in AA format (IEC LR6 – NEDA 15A) 6 optional rechargeable batteries (rechargeable elements) NiMH or NiCd in AA format (IEC LR6 – NEDA 15A). 	
Rechargeable batteries:		
Capacity:	NiMh: 1800mAh	
(minimum)	NiCd: 900mAh	
Nominal voltage:	1.2V per battery or 7.2V in total.	
Battery life	Without backlighting	With backlighting
AA standard batteries	> 40 hours	> 20 hours
NiMH 1800mAh rechargeable batteries	> 30 hours	> 16 hours
NiCd 900mAh rechargeable batteries	> 15 hours	> 8 hours
Temperature:		
Operating	32° to 122°F (0°C to 50°C)	
Storage	Standard batteries: -4° to 158°F (-20°C to 70°C) Rechargeable batteries: -4° to 122°F (-20°C to 50°C)	



NOTE: Rechargeable batteries must be recharged on an external charger.

AC Power (external power supply)

Operating Range:

120V ± 10% @ 60Hz ; 230V ± 10% @ 50Hz (model dependent)

Max Power: 23.7VA

The instrument may be powered by an optional AC Power Adapter (Cat. #2140.37)

3.2.5 Accuracy Specifications (excluding current probes)

Function		Measurement range		Display Resolution	Accuracy (% of Reading \pm ct)
		Minimum	Maximum		
Frequency		40Hz	69Hz	0.01Hz	$\pm(1\text{ct})$
TRMS voltage		6V	600V ⁽⁶⁾	0.1V	$\pm(0.5\%+2\text{cts})$
DC voltage		6V	600V	0.1V	$\pm(1\%+5\text{cts})$
TRMS current	Excluding AmpFlex [®] & MiniFlex ^{®*}	$I_{\text{nom}} \div 1000$ [A]	$1.2 \times I_{\text{nom}}$ [A]	0.1A $I < 1000A$	$\pm(0.5\%+2\text{cts})$
	AmpFlex [®] & MiniFlex ^{®*}	10A	6500A	1A $I \geq 1000A$	$\pm(0.5\%+1\text{ct})$
DC current		1A	1700A ⁽¹⁾	0.1A $I < 1000A$	$\pm(1\%+1A)$
				1A $I \geq 1000A$	
Current Peak	Excluding AmpFlex [®] & MiniFlex ^{®*}	0A	$1.7 \times I_{\text{nom}}$ [A] ⁽²⁾	0.1A $I < 1000A$	$\pm(1\%+1A)$
	AmpFlex [®] & MiniFlex ^{®*}		9190A ⁽³⁾	1A $I \geq 1000A$	
Half-period TRMS current ⁽⁴⁾	Excluding AmpFlex [®] & MiniFlex ^{®*}	$I_{\text{nom}} \div 100$ [A]	$1.2 \times I_{\text{nom}}$ [A]	0.1A $I < 1000A$	$\pm(1\%+5\text{cts})$
				1A $I \geq 1000A$	$\pm(1\%+1\text{ct})$
	AmpFlex [®] & MiniFlex ^{®*}	100A	6500A	0.1A $I < 1000A$	$\pm(1.5\%+4A)$
Peak voltage		6V	850V ⁽⁴⁾	0.1 V	$\pm(1\%+5\text{cts})$
Half-period TRMS Voltage ⁽⁵⁾		6V	600V	0.1V	$\pm(0.8\%+5\text{cts})$
Peak Factor		1	4	0.01	$\pm(1\%+2\text{cts})$
		4	9.99	0.01	$\pm(5\%+2\text{cts})$
Active Power	Excluding AmpFlex [®] & MiniFlex ^{®*}	0W	9999kW	4 digits	$\pm(1\%)$ $\text{Cos } \phi \geq 0.8$ $\pm(1.5\%+10\text{cts})$ $0.2 \leq \text{Cos } \phi < 0.8$
	AmpFlex [®] & MiniFlex ^{®*}	0W	9999kW	4 digits	$\pm(1\%)$ $\text{Cos } \phi \geq 0.8$ $\pm(1.5\%+10\text{cts})$ $0.2 \leq \text{Cos } \phi < 0.8$
Reactive Powers	Excluding AmpFlex [®] & MiniFlex ^{®*}	0VAR	9999kVAR	4 digits	$\pm(1\%)$ $\text{Sin } \phi \geq 0.5$ $\pm(1.5\%+10\text{cts})$ $0.2 \leq \text{Sin } \phi < 0.5$
	AmpFlex [®] & MiniFlex ^{®*}	0VAR	9999kVAR	4 digits	$\pm(1.5\%)$ $\text{Sin } \phi \geq 0.5$ $\pm(2.5\%+20\text{cts})$ $0.2 \leq \text{Sin } \phi < 0.5$
Apparent power		0	9999kVA	4 digits	$\pm(1\%)$
Power factor		-1	1	0.001	$\pm(1.5\%)$ $\text{Cos } \phi \geq 0.5$
					$\pm(1.5\%+10\text{cts})$ $0.2 \leq \text{Cos } \phi < 0.5$

*NOTE: MiniFlex[®] specified up to 1000A only

Function	Measurement range		Display resolution	Accuracy
	Minimum	Maximum		
Displacement factor (DPF)	-1	1	0.001	$\pm(1^\circ)$ on ϕ $\pm(5\text{cts})$ on DPF
Level of harmonics order $\in [1; 50]$ ($V_{RMS} > 50V$)	0%	999.9%	0.1%	$\pm(1\%+5\text{cts})$
Without AmpFlex® or MiniFlex®* ($I_{RMS} > 3 \times I_{nom} \div 100$)				
AmpFlex® or MiniFlex®* ($I_{RMS} > I_{nom} \div 10$)				
Global level of harmonics (THD-F) order ≤ 50	0%	999.9%	0.1%	$\pm(1\%+5\text{cts})$
Distortion factor (THD-R) order ≤ 50	0%	999.9%	0.1%	$\pm(1\%+10\text{cts})$
K factor	1	99.99	0.01	$\pm(5\%)$
Rotation Speed	6 RPM	120 kRPM	0.1 RPM $V < 1$ kRPM	$\pm (0.5 \%)$
			1 RPM	
			$1 \text{ kRPM} \leq V < 10 \text{ kRPM}$	
			10 RPM $10 \text{ kRPM} \leq V < 100 \text{ kRPM}$	
			100 RPM $V \geq 100 \text{ kRPM}$	
Temperature	-200.0 °C	850.0 °C	0.1 °C	$\pm (1 \% + 1 \text{ }^\circ\text{C})$ ⁽⁶⁾
	-328.0 °F	1562 °F	0.1 °F $T < 1000^\circ\text{F}$ 1 °F $T \geq 1000^\circ\text{F}$	$\pm (1.8 \% + 2 \text{ }^\circ\text{F})$ ⁽⁶⁾
Resistance	0.0 Ω	2000 Ω	1 Ω $R < 1000\Omega$	$\pm (1.5 \% + 2 \text{ cts})$

(1) $1.2 \times 1000 \times \sqrt{2} = 1700A$

(2) $1.2 \times I_{nom} \times \sqrt{2} = 1.7 \times I_{nom}$

(3) $6500 \times \sqrt{2} = 9190A$

(4) $600 \times \sqrt{2} = 850V$

(5) For the phase-to-earth voltage measurement (phase-neutral). For the phase-to-phase voltage measurement (phase-phase), in balanced three-phase mode, it is possible to reach 660V_{RMS} (balanced three-phase network having a phase-neutral voltage of 380V_{RMS}).

(6) An additional influence of 3.5°C must be added in an environment disturbed by radiation fields. In other words, the error in the field of reference in an environment disturbed by radiation fields is $\pm (1 \% + 4.5^\circ\text{C})$.

An additional influence of 6.2°F must be added in an environment disturbed by radiation fields. In other words, the error in the field of reference in an environment disturbed by radiation fields is $\pm (1 \% + 8^\circ\text{F})$.

NOTE: The uncertainties given for power and energy measurements are maximum for $\text{Cos } \phi = 1$ or $\text{Sin } \phi = 1$ and are typical for the other phase shifts.

3.2.6 Accuracy Specifications of the Current Probes

These characteristics are stated after linearization. The errors of the sensors are compensated by a typical correction inside the instrument. This typical correction is in phase and in amplitude according to the type of sensor connected (detected automatically) and the gain of the current acquisition chain used.

The measurement error in RMS current and the phase error are additional errors (they must therefore be added to those of the instrument alone) stated as influences on the calculations performed by the analyzer (powers, power factors, displacement factors, etc.).

Type of sensor	TRMS current	Maximum error on IRMS (% of Reading \pm ct)	Maximum error on ϕ
MR193 1000A	[1A; 10A]	$\pm(1.5\% + 1A)$	Not Specified
	[10A; 100A]		$\pm(2^\circ)$
	[100A; 800A]	$\pm(3\%)$	$\pm(1.5^\circ)$
	[800A; 1200A]	$\pm(5\%)$	
	[1200A; 1400A] DC only		
SR193 1000A	[1A; 3A]	$\pm(0.8\%)$	Not Specified
	[3A; 10A]		$\pm(1^\circ)$
	[10A; 100A]	$\pm(0.3\%)$	$\pm(0.5^\circ)$
	[100A; 1200A]	$\pm(0.2\%)$	$\pm(0.3^\circ)$
AmpFlex® 3000A	[10A; 100A]	$\pm(3\%)$	$\pm(1^\circ)$
	[100A; 6500A]	$\pm(2\%)$	$\pm(0.5^\circ)$
MiniFlex® 1000A	[10A; 100A]	$\pm(3\%)$	$\pm(1^\circ)$
	[100A; 1000A]	$\pm(2\%)$	$\pm(0.5^\circ)$
MN93 200A	[0,5A; 2A]	$\pm(3\% + 1A)$	Not Specified
	[2A; 10A]		$\pm(6^\circ)$
	[10A; 100A]	$\pm(2.5\% + 1A)$	$\pm(3^\circ)$
	[100A; 240A]	$\pm(1\% + 1A)$	$\pm(2^\circ)$
MN193 100A	[100mA; 300mA]	$\pm(0.7\% + 2mA)$	Not Specified
	[300mA; 1A]		$\pm(1.5^\circ)$
	[1A; 120A]	$\pm(0.7\%)$	$\pm(0.7^\circ)$
MN193 5A	[5mA; 50mA]	$\pm(1\% + 0.1mA)$	$\pm(1.7^\circ)$
	[50mA; 500mA]	$\pm(1\%)$	$\pm(1^\circ)$
	[500mA; 6A]	$\pm(0.7\%)$	
5A Adapter	[5mA; 50mA]	$\pm(1\%)$	$\pm(1^\circ)$
	[50mA; 6A]	$\pm(0.5\%)$	$\pm(0^\circ)$
SL261 10mV/A	[0 A ; 40 A]	$\pm(2\% + 50mA)$	$\pm(0.5^\circ)$
	[40 A; 100 A]	$\pm(5\%)$	$\pm(0.5^\circ)$
SL261 100mV/A	[0 A ; 10 A]	$\pm(1.5\% + 50mA)$	$\pm(1^\circ)$

3.2.7 Current Probes and Sensors

When installing probes, face the arrow on the probe in the direction of the load.

Model SR193	
Nominal Range	1000AAC for $f \leq 1\text{kHz}$
Measurement Range	1 to 1200AAC max ($I > 1000\text{A}$ not continuously)
Probe Output Signal	1mVAC/AAC
Maximum Clamping Diameter	2" (52mm)
Safety	EN 61010-2-032, Pollution Degree 2, 600V CAT IV, 1000V CAT III

NOTE: Currents $< 0.5\text{A}$ will be displayed as zero. Neutral current measures down to 0A.

Model MN93	
Nominal Range	200AAC for $f \leq 1\text{kHz}$
Measurement Range	2 to 240AAC max ($I > 200\text{A}$ not permanent)
Probe Output Signal	5mVAC/AAC
Maximum Clamping Diameter	0.8" (20mm)
Safety	EN 61010-2-032, Pollution Degree 2, 300V CAT IV, 600V CAT III

NOTE: Currents $< 0.5\text{A}$ will be displayed as zero. Neutral current measures down to 0A.

Model MR193	
Nominal Range	1000AAC, 1400ADC max
Measurement Range	10 to 1000AAC, 10 to 1300APEAK AC+DC
Probe Output Signal	1 mV/A
Maximum Clamping Diameter	One 1.6" (42mm) or two 0.98" (25.4mm) or two bus bars 1.96 x 0.19" (50 x 5mm)
Safety	EN 61010-2-032, Pollution Degree 2, 300V CAT IV, 600V CAT III

NOTE: Currents $< 1\text{AAC/DC}$ will be displayed as zero. Neutral current measures down to 0A.

Model MN193	
Nominal Range	5A and 100AAC
Measurement Range	5A: 0.005 to 6AAC max (1 to 1200A with ratio 1000/5 selected) 100A: 0.1 to 120AAC max
Probe Output Signal	5A: 200mV/AAC; 100A: 10mV/AAC
Maximum Clamping Diameter	0.8" (20mm)
Safety	EN 61010-2-032, Pollution Degree 2, 300V CAT IV, 600V CAT III

The 5A range of the MN193 is designed to work with secondary current transformers.

Best accuracy is available when entering the transformer ratio (e.g. 1000/5A). When used to measure 5A direct, the resolution will be limited to 0.1A max.

NOTE: Currents $< (\text{Primary} \times 5) \div (\text{Secondary} \times 1000)$ or $< 250\text{mA}$ on the 5A range and $< 0.2\text{A}$ on the 100A range will be displayed as zero with this probe. Power calculations will also be zeroed when the current is zeroed when the current is zeroed.

AmpFlex® Sensors	
Nominal Range	3000AAC
Measurement Range	10 to 6500AAC
Probe Output Signal*	140mVAC/3000AAC at 60Hz
Sensor	Length = 24" (610mm); Ø = 7.64" (190mm) Length = 36" (910mm); Ø = 11.46" (290mm)
Safety	EN 61010-2-032, Pollution Degree 2, 600V CAT IV, 1000V CAT III

*Output is proportional to the amplitude and frequency of the measured current.

NOTE: Currents <10A will be displayed as zero. Neutral current measures down to 0A.

MiniFlex® Sensors	
Nominal Range	1000AAC
Measurement Range	10 to 1000AAC
Probe Output Signal*	47µVAC/1000AAC at 60Hz
Sensor	Length = 10" (250mm); Ø = 2.75" (70mm)
Safety	EN 61010-2-032, Pollution Degree 2, 600V CAT IV, 1000V CAT III

*Output is proportional to the amplitude and frequency of the measured current.

NOTE: Currents <10A will be displayed as zero. Neutral current measures down to 0A.

Model SL 261	
Nominal Range	50mA AC/DC- 100A Peak+DCAC
Measurement Range	50mA to 10A, 1A to 100A
Probe Output Signal*	1A: 100mV/A; 100A-10mV/A
Maximum Clamping Diameter	0.46" (11.8mm)
Safety	EN 61010-2-032, Pollution Degree 2, 600V CAT III 300V CAT IV

3.3 Mechanical Specifications

Dimensions: 8.3 x 4.3 x 2.4" (211 x 108 x 60mm)

Weight: 1.94 lbs (880g)

Shock and Vibration: per EN 61010-1

Tightness: IP 54 per EN 60529 (*electrical IP2X for the terminals*)

3.4 Environmental Specifications

Operating Temperature: 32° to 122°F (0° to 50°C)

Storage Temperature (<30 days):

-4° to +122°F (-20 to +50°C) with standard batteries

50° to 104°F (10° to 40°C) with rechargeable batteries

Altitude: Operating: 0 to 2000 meters (6560 ft)

Non-Operating: 0 to 10,000 meters (32800 ft)

Operating Relative Humidity: 10 to 85%

3.5 Safety Specifications

Electrical Safety



600V CAT III, Pollution Degree 2

EN 61010-31: 2002

EN 61010-1: 2001

EN 61010-2: 1995

Electromagnetic Compatibility

Immunity: EN 61236-1 A2

Emission: EN 61236-1 A2

Electrostatic discharges: IEC 1000-4-2

Radiation field resistance: IEC 1000-4-3

Fast transients resistance: IEC 1000-4-4

Electric shock resistance: IEC 1000-4-5

Conducted RF interference: IEC 1000-4-6

Interruption of Voltage: IEC 1000-4-11

OPERATION

4.1 General Operating Instructions



WARNING: Never connect voltages exceeding 600Vrms

Turn the rotary switch to any position other than OFF. For detailed information on button functions and rotary switch modes, refer to § 2.6 and § 4.6.

The Model 8220 displays three screens as follows:

- **First Screen:** Display of all symbols that are used, depending on mode.
- **Second Screen:** Display of the model number of the instrument.
- **Third Screen:** Display of the measurement page corresponding to the position of the switch.



NOTE: If a current sensor is connected, the bottom of the second screen indicates the type of current sensor connected, with the following code:

<i>PA C</i>	MR193 1000A Current Probe
<i>Pa</i>	MN93 200A Current Probe
<i>PaA</i>	MN193 100A or 5A Current Probe
<i>C</i>	SR193 1000A Current Probe
<i>AMPF</i>	AmpFlex® 3000A or MiniFlex® 1000A Current Sensor
<i>E3a</i>	SL261 10A or 100A Current Probe
<i>AdAP</i>	Three-phase 5A Adapter

The Model 8220 works from a battery only if the battery is sufficiently charged. The instrument can be used with the optional AC power unit connected to the power jack (see Figure 2-1, item 1).

4.2 Connecting the Cables

Connect the measurement cables to the Model 8220.

- **Voltage measurement:** COM and (+) terminals.
- **Current measurement:** 4-pin connector. On the current sensor, do not forget to position the switch (if available) to a sensitivity suited to the current to be measured.

The measurement cables are connected to the circuit to be monitored as per the following diagrams.

4.2.1 Single-phase Network

All voltages measured will be line-to-neutral.

The $\boxed{3\Phi}$ mode (balanced three-phase) will be de-activated (\boxed{OFF}). See § 4.6.2.

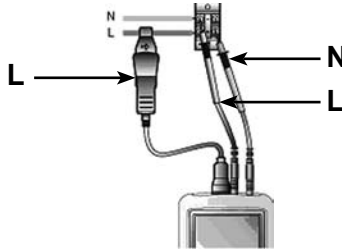

Figure 4-1
Single-phase connection

4.2.2 Balanced Three-phase Network

All voltages measured will be phase-to-phase.

The $\boxed{3\Phi}$ mode (balanced three-phase) will be activated (\boxed{ON}). See § 4.6.2.

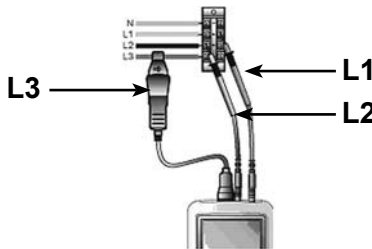



Figure 4-2
Balanced three-phase connection

4.3 Using the 5A Adapter / MN193 5A Current Probe

If the 5A adapter or the MN193 5A clamp is used, an adjustment to the transformation ratio (primary current (1A to 2999A) / secondary current (1A or 5A) is required.

Proceed as follows:

1. Connect the current sensor.
2. Select the Configuration mode by positioning the rotary switch to  SETUP.
3. Adjust the sensor's primary current.
 - Select the *PFI* parameter (primary adjustment page) with the ◀▶ buttons.
 - With the white and yellow buttons, adjust the primary current (*PFI*) of the transformation ratio. See § 4.5 for details.
4. Adjust the secondary sensor current.
 - Select the *SEI* parameter (secondary adjustment page) with the ◀▶ buttons.
 - With the white and yellow buttons, adjust the secondary current (*SEI*) of the transformation ratio to 1 or 5 A. See § 4.5 for details.

4.4 Automatic Shut-off



By default, the automatic shut-off feature is activated each time the Model 8220 is turned on.

To de-activate:

1. Turn the unit OFF by turning the rotary switch to the OFF position.
2. Turn the unit back ON by turning the rotary switch to any other position.
3. When the first screen is displayed (display of all symbols), press and hold the yellow button until a beep is heard.
4. The screen indicates *no AUTO OFF* (No automatic shut-off).

4.5 Instrument Configuration

This rotary switch position is designed for configuring the parameters used by the Model 8220. Once the configuration has been saved in the non-volatile memory it can be accessed even after the instrument is shut off, including during a battery change.

Turn the rotary switch to the  position. There are 6 pages in this mode. Use the   buttons to move through them.

Page 1: **St r t** Parameter

The **St r t** symbol means *start*.

This parameter is used to configure the Inrush  mode.

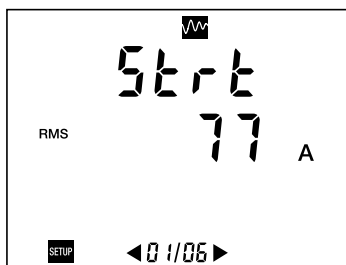



Figure 4-3
Display of start threshold current.

The **St r t** parameter sets the effective half-cycle current value, serving as the motor start threshold.

When the motor starting current reaches or exceeds this threshold, the Model 8220 will count the time during which the effective half-cycle current value is strictly in excess of the effective half-cycle end value (see Figure 4-14).

The value is set using the White and Yellow ( ) buttons. The minimum and maximum values are 0 and 5999A.

Page 2: **H y S t** Parameter

The **H y S t** symbol means *hysteresis*.

This parameter is used to configure the Inrush  mode.

The **H y S t** parameter sets the effective half-cycle current value serving as the end of motor start threshold. As soon as the motor starting current is over or equal to the effective half-cycle current end (stop) value, the Model 8220 will stop counting the starting time (see Figure 4-13).

The value is set using the White and Yellow () buttons. The preset values are 0, 1, 2, 5 and 10%.



NOTE: The effective half-cycle stopping value is calculated using the following formula: [effective half-cycle stopping value] = [effective half-cycle starting value] × (100 – [hysteresis]) ÷ 100.

Page 3: *PFI* Parameter

The *PFI* symbol means *primary*.

This parameter configures the primary current of the transformation ratio (**A**).



NOTE: This screen is only displayed if the Model 8220 is connected to a 5A adapter or to the MN193 5A clamp. For all of the other sensors, which do not require any adjustment, this screen is not displayed:

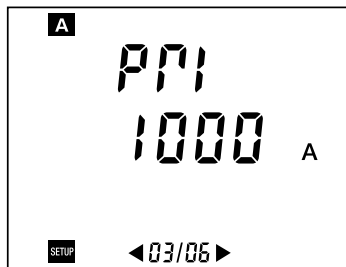

Figure 4-4
Display of the effective primary current.

The *PFI* parameter defines the value of the primary effective current for the MN193 clamp (5A) or the 5A adapter.

The value is set using the White and Yellow () buttons. The minimum and maximum terminals are 0 and 2999A.

Page 4: SEC Parameter

The SEC symbol means *secondary*.

This parameter configures the primary current of the transformation ratio (A).



NOTE: This screen is only displayed if the Model 8220 is connected to a 5A adapter or to the MN193 5A clamp. For all of the other sensors, which do not require any adjustment, this screen is not displayed:

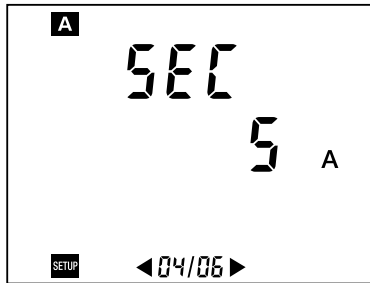

Figure 4-5
Display of the effective secondary current.

The parameter defines the value of the secondary effective current for the MN193 clamp (5A) or the 5A adapter.

The value is set using the White and Yellow () buttons. The preset values are 1 and 5A.

This parameter configures the range of the Model 8220.



This SL261 screen is displayed only if the Model 8220 is connected to an SL261 probe (AC/DC)

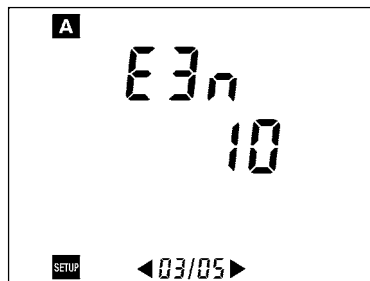

Figure 4-6
Display of the parameter concerning the sensitivity used by the probe

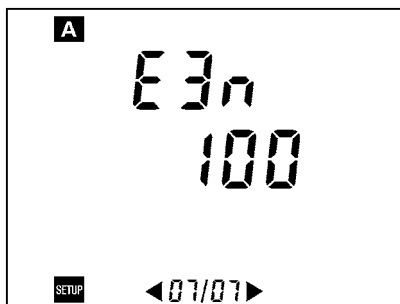

Figure 4-7
Display of the parameter concerning the sensitivity used on the clamp

The range displayed on the screen of the Model 8220 must be consistent with the sensitivity used on the SL261 probe 10A for the 10mV/A sensitivity (Figure 4-6) and 100A for the 100mV/A sensitivity (Figure 4-7).

The value is selected using the White and Yellow () buttons. The preset values are 10 and 100 (10mV/A and 100mV/A).

Page 5: $\mathcal{E}Pr$ Parameter

The $\mathcal{E}Pr$ symbol means *event per rotation*.

This parameter is designed to configure the rotation speed mode (RPM).

The $\mathcal{E}Pr$ parameter defines the number of events per rotation for the measurement of rotation speed for a machine in operation.

Example: If a tachometer signal provides two pulses per revolutions, this parameter would be set to 2.

The value is set using the White and Yellow () buttons. The minimum and maximum values are 1 and 99.

Page 6: $\mathcal{E}hr$ Parameter

The $\mathcal{E}hr$ symbol means *threshold*.

This parameter is designed to configure the rotation speed mode (RPM).



Figure 4-8
Display of the threshold voltage of the tachometer sensor.

The *thr* parameter defines the threshold voltage value used to detect an event (pulse on the tachometer signal). Since the signal received by the Model 8220 can be unipolar or bipolar, two types of threshold (0.3 and 1.1V) can be selected. The recommended selection is as follows:

- bipolar signals: 0.3V threshold
- unipolar signals: 1.1V threshold

In both cases, the hysteresis is 0.2 V.

The value is set using the White and Yellow () buttons. See below for the graphs for this hysteresis.

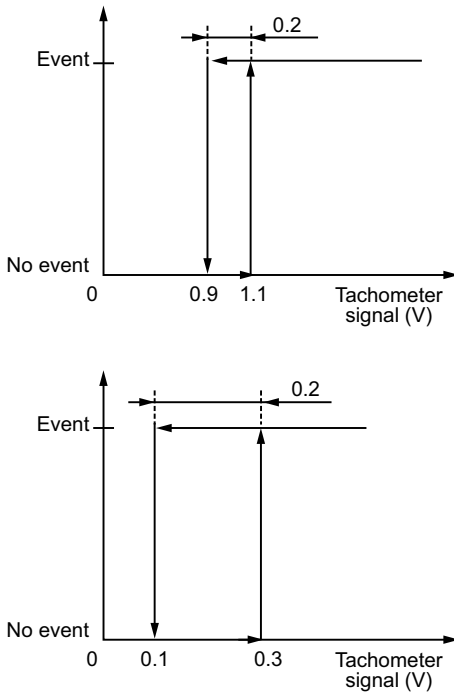



Figure 4-9

4.6 Rotary Switch Modes

For all rotary positions that have two functions, the following applies:

-  To access the second function of a rotary position, turn the switch to the desired position then press the **Yellow** button.
-  To return to the first function in that rotary position, press the **White** button.

4.6.1 Voltage and Current



NOTE: The following illustrations are generic examples. Screen values and appearances will vary.

First Function: **VOLTAGE MODE**

There are 4 pages (screen displays) in this mode. Use the ◀▶ buttons to move through them.

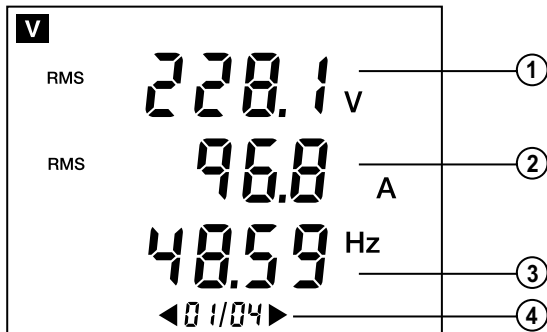

Figure 4-10

ITEM	1st Page	2nd Page	3rd Page	4th Page
1.	Root mean square value (Vrms)	Root mean square value (Vrms)	Effective maximum voltage half-cycle value (Vrms 1/2 max)*	Maximum voltage crest value (VPEAK+)
2.	Root mean square value (Arms)	Continuous voltage value (VDC)	Root mean square value (Vrms)	Minimum voltage crest value (VPEAK-)
3.	Network frequency (Hz)	Voltage crest factor (VCF)	Effective minimum voltage half-cycle value (Vrms 1/2 max)*	—
4.	# of page displayed / total # of pages			

* The effective maximum and minimum half-cycle values may be reinitialized by pressing the Delete button.

Second Function: CURRENT MODE

There are 4 pages (screen displays) in this mode. Use the ◀▶ buttons to move through them.

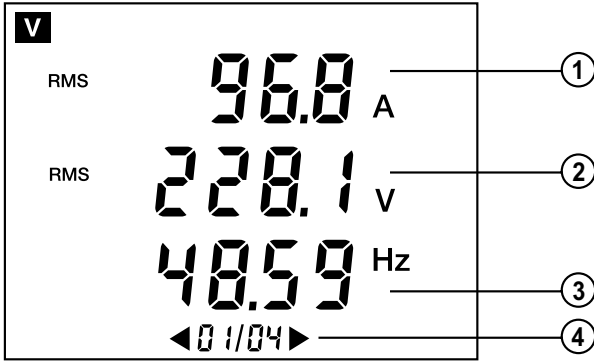

Figure 4-11

ITEM	1st Page	2nd Page	3rd Page	4th Page
1.	Root mean square value (Arms)	Root mean square value (Arms)	Effective maximum current half-cycle value (Vrms 1/2max)*	Maximum current crest value (VPEAK+)
2.	Root mean square value (Vrms)	Continuous current value (ADC) for the MR clamps only.	Root mean square value (Arms)	Minimum current crest value (VPEAK-)
3.	Network frequency (Hz)	Current crest factor (ACF)	Effective minimum minimum half-cycle value (Vrms 1/2max)*	Current K factor (AKF)
4.	# of page displayed / total # of pages			

* The effective maximum and minimum half-cycle values may be reinitialized by pressing the Delete button.

4.6.2 Power and Three-Phase Calculations



First Function: POWER MODE **W**

There are 12 pages in this mode. Use the ◀▶ buttons to move through them.

1st and 2nd Pages:

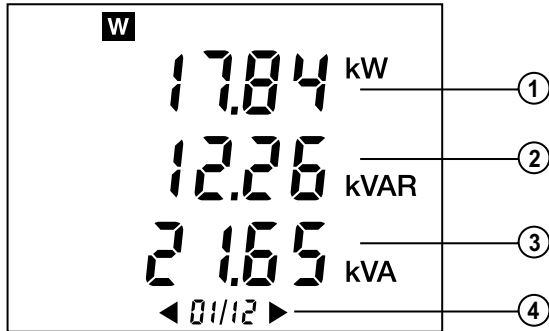

Figure 4-12

ITEM	1st Page*	2nd Page**
1.	Active power (W)	Continuous power (WDC)
2.	Reactive power (VAR)	Power factor (PF)
3.	Apparent power (VA)	Displacement factor (DPF, also noted as Φ)
4.	# of page displayed / total # of pages	

*The powers displayed are the total powers (sum of 3 phases) if the **3Φ** symbol is displayed.

The total continuous power (WDC) is not shown if the **3Φ symbol is displayed.

4.6.2.1 Energy Measurement Functions (counting)

The energy counters start and count the totals for the various types of energy (the eight energy counters – 4 consumed energy counters and 4 generated energy counters - are started)

Energy counting is not affected by:

- Taking photos
- Retrieval of photos by the PC for viewing with “Power Analyzer Transfer”
- Modbus real-time serial link with “Power Analyzer Transfer”

3rd Page:

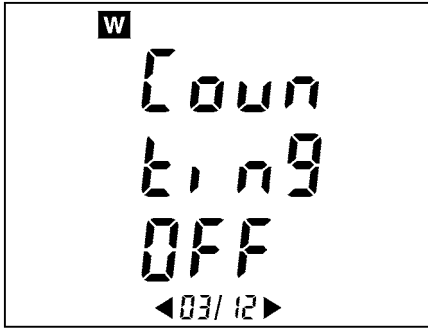

Figure 4-13

Counter statuses are:

- On <=> counter operative
- Stop <=> counting stopped (counter values)
- Off <=> counter not operative (counter values reading 0)

If the instrument is not in “view a photo” mode when page 3/12 is in Power Mode, **W 3Φ** is displayed.

- The button generates a switch from OFF to ON
- The button either generates a switch from ON to Stop or from Stop to OFF.

The causes for an automatic switch from ON to Stop:

- Current sensor removed
- Rotary switch on a position other than **V A**, **W 3Φ** or 
- Viewing of a photo

4th Page:

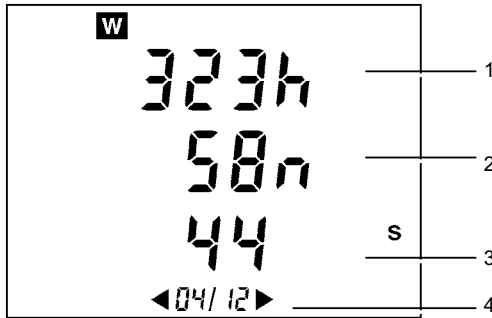

Figure 4-14

ITEM	4th Page
1.	Number of hours (h)
2.	Number of minutes (n)
3.	Number of seconds (s)
4.	# of page displayed / total # of pages

NOTE: Beyond 999h, 59m, 59s, “---h --m --s” is displayed, but the internal counting time continues to function correctly.

Pages 5/12 to 12/12:

Pages 5, 6, 7 and 8 concern power received by the “Load” side.

Pages 9, 10, 11 and 12 concern power generated by the load side and therefore received by the “Supply” side.

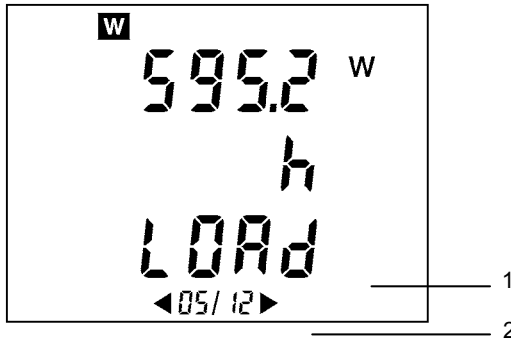

Figure 4-15

ITEM	5th Page
1.	Load or supply (SuPP)
2.	# of page displayed / total # of pages

Power is displayed in the following formats:

- [000.1 ; 999.9]
- [1.000 k ; 9999 k]
- [10.0 M ; 999 M]
- [1.00 G ; 999 G]

Beyond 999 999 999 999 xh (999 Gxh) “----” is displayed but the internal counters continue to function correctly. The precision of the internal counters is greater than that of the power displayed on the instrument (this is due to display limitations – number of digits available).

Pages 6 and 10 out of 12 concern inductive reactive energy “L”.

Pages 7 and 11 out of 12 concern capacitive reactive energy “C”.

Second Function: THREE-PHASE CALCULATIONS 3Φ

When in view mode, the display indicates *OFF* or *On*.

OFF: The calculations associated with the connection of the Model 8220 to a three-phase balanced network are deactivated. This choice is selected when measuring single-phase networks.

On: The calculations associated with the connection of the Model 8220 to a three-phase balanced network are activated. This choice is selected when measuring three-phase balanced networks.

The choice is made using the ◀ and ▶ buttons.

4.6.3 Voltage and Current Harmonics



This measures the total harmonic distortion rate on voltage and current, as well as the effective value, the harmonic distortion factor, any continuous harmonic component and harmonics up to the 50th.

First Function: VOLTAGE HARMONIC MODE

There are 52 measurement pages in this mode. Use the ◀▶ buttons to move through them.

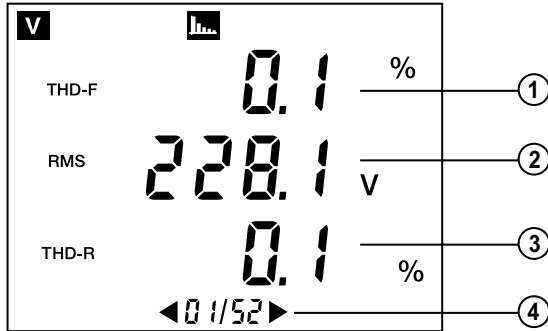

Figure 4-16

ITEM	1st Page	2nd Page	3rd Page
1.	Rate of total voltage harmonic distortion (VTHD-F, also noted as VTHD)	Number of voltage harmonic considered	Number of voltage harmonic considered
2.	Root mean square value (Vrms)	The continuous harmonic component value	Effective value of the harmonic component considered
3.	Voltage distortion factor (VTHD-R, also noted as VDF)	Percentage of the continuous value compared with the effective fundamental value	Percentage of this effective value compared with the effective fundamental value
4.	# of page displayed / total # of pages		

Second Function: CURRENT HARMONIC MODE

There are 52 measurement pages in this mode when an MR probe is connected and 51 measurement pages for all the other current probes.

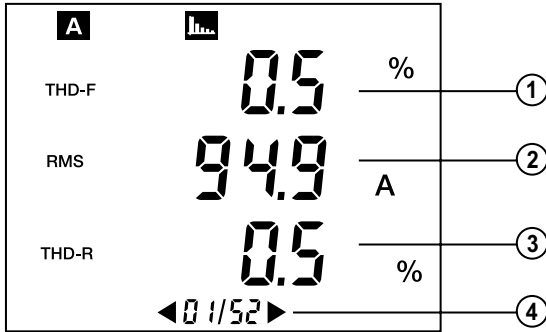

Figure 4-17

ITEM	1st Page	2nd Page	3rd Page
1.	Rate of total current harmonic distortion (ATHD-F, also noted as ATHD)	Number of current harmonic considered	Number of current harmonic considered
2.	Root mean square value (Arms)	The continuous harmonic component value	Effective value of the harmonic component considered
3.	Current distortion factor (ATHD-R, also noted as ADF)	*Percentage of the continuous value compared with the effective fundamental value	**Percentage of this effective value compared with the effective fundamental value. In this example, the fundamental is 100% of itself
4.	# of page displayed / total # of pages		

*With an MR current probe connected

**Without an MR current probe connected

4.6.4 Inrush and Phase Rotation



First Function: INRUSH MODE

This mode requires the Model 8220 to be pre-configured (refer to § 4.5). The leads (voltage and current) can be connected either in single-phase or balanced three-phase mode. During steps 2, 3 and 4, it is possible to go back to the first step (step 1/4) by pressing the ◀ button.

Step 1:

- Turn the rotary switch to the  position. The display will indicate *rdy* (ready).
- Press the ▶ button to move to Step 2.

Step 2:

- The motor to be monitored should now be switched on. The Model 8220 waits until the effective half-cycle current exceeds the current threshold for the configured motor start.
- The effective current calculated over one second is continuously displayed. The Model 8220 automatically moves on to Step 3.

Step 3:

- As soon as the motor starting threshold is reached, the timer is started (Fig. 4-18, No. 2).
- Once the motor to be monitored is running, the Model 8220 waits until the effective half-cycle current goes below the current set threshold (end of start threshold). The effective current calculated over one second is continuously displayed (Fig. 4-18, No. 1). The unit automatically moves on to Step 4.

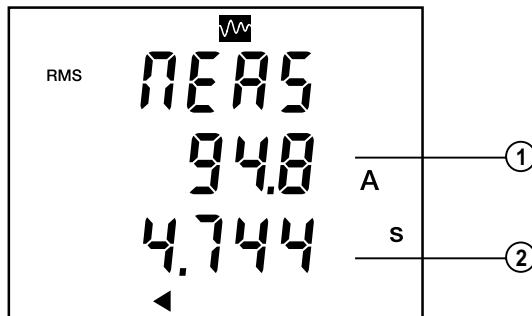

Figure 4-18

The timer (bottom value) is active until the low current threshold has been reached.

Step 4:

- As soon as the end of motor starting threshold has been reached, the results are displayed.

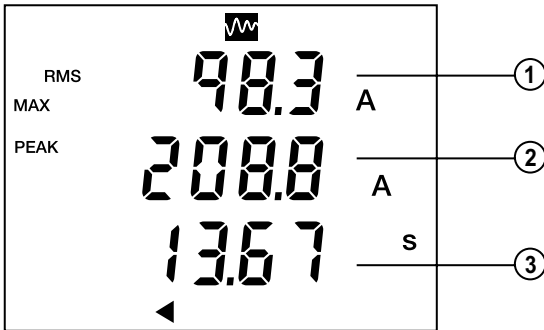

Figure 4-19

ITEM	MEASUREMENT
1.	Effective maximum half-cycle value of starting current.
2.	Absolute instantaneous value of starting current.
3.	Duration of motor starting (in seconds).

Second Function: PHASE ROTATION MODE

This mode enables the user to determine the order of the phases of a three-phase network using the method known as “2 wire”.



NOTE: The activation of the balanced three-phase mode has no effect on determining the order of the phases (3Φ can be 0_n or 0FF). The most important point is to respect the voltage connections as directed in 1 and 3.

Step 1:

- Turn the rotary switch to the  position then press the Yellow button. The display will indicate that the Model 8220 is ready.
- Once the test leads are connected to the suspected L1 and L2 phases, press the ► button.
- The *NEAS* message is displayed briefly.

Step 2:

- The display will show the following screen.

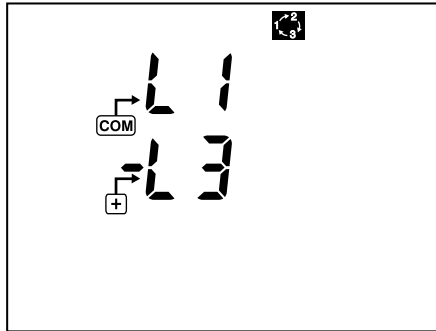

Figure 4-18

- The user should then connect the L3 phase to the input (+) of the 8220, within 10 seconds, after which time the following error message t i n e o u t (time limit exceeded) is displayed. The user must start the sequence again from the beginning (Step 1).
- As soon as the test leads are connected to the circuit, the 8220 automatically moves to Step 3.



NOTE: If the display indicates E r r (Error) an error has been detected during the determination of the order of the phases.

This error may be due to one of the following causes:

- The three-phase network frequency is unstable.
- The three-phase network frequency is outside the 40 to 70Hz range.
- The voltage signal is too weak (below 10VRMS).
- Operations were incorrectly carried out.

To return to the first Step, press the ◀ button.

Step 3:

- The display will then show either:
 - Correct order of phases: L1-L2-L3
 - Incorrect order of phases: L3-L2-L1

4.6.5 Rotation Speed (RPM)

This mode requires the Model 8220 to be pre-configured (refer to § 4.5).

In this position, the Model 8220 measures the rotation speed of a turning element.



NOTE: The tachometer signal should be applied into the voltage (+) and (COM) terminals of the Model 8220. The unit then measures the interval of time between each signal pulse (event) and subtracts the rotation speed in revolutions per minute.

4.6.6 Temperature and Resistance

In this position, the Model 8220 measures the temperature (using an external probe not provided) or the resistance of an electrical circuit.

First Function: TEMPERATURE MODE

The Model 8220 displays the temperature measured using a 100 platinum probe (not provided), connected to the (+) and (COM) terminals. The measurement is displayed simultaneously in degrees Celsius (°C) and degrees Fahrenheit (°F).

Second Function: RESISTANCE MODE

Two automatic ranges are available:

- 0 to 400Ω: under 20Ω (by default) a beeping sound is emitted
- 400 to 2000Ω

DATAVIEW® SOFTWARE

5.1 Installing DataView®



DO NOT CONNECT THE INSTRUMENT TO THE PC BEFORE INSTALLING THE SOFTWARE AND DRIVERS.

Minimum Computer Requirements:

- Windows XP / Windows Vista & Windows 7 (32/64 bit)
- 256MB of RAM for Windows XP
1GB of RAM for Windows Vista & Windows 7 (32 bit)
2GB or RAM for Windows Vista & Windows 7 (64 bit)
- 80MB of hard disk space (200MB recommended)

Windows is a registered trademark of Microsoft Corporation in the United States and other countries.

NOTE: When installing, the user must have Administrative access rights during the installation. The users access rights can be changed after the installation is complete.

DataView® must be reinstalled for each user in a multi-user system.

1. Insert the DataView® CD into your CD-ROM drive.
If auto-run is enabled, the Setup program will start automatically. If auto-run is not enabled, select Run from the Start menu and type in **D:\SETUP** (if your CD-ROM drive is drive D. If this is not the case, substitute the appropriate drive letter).



If installing onto a Vista based computer the **User Account Control** dialog box will be displayed. Select the **Allow** option to proceed.

2. A **Set-up** window, similar to the one below, will appear.

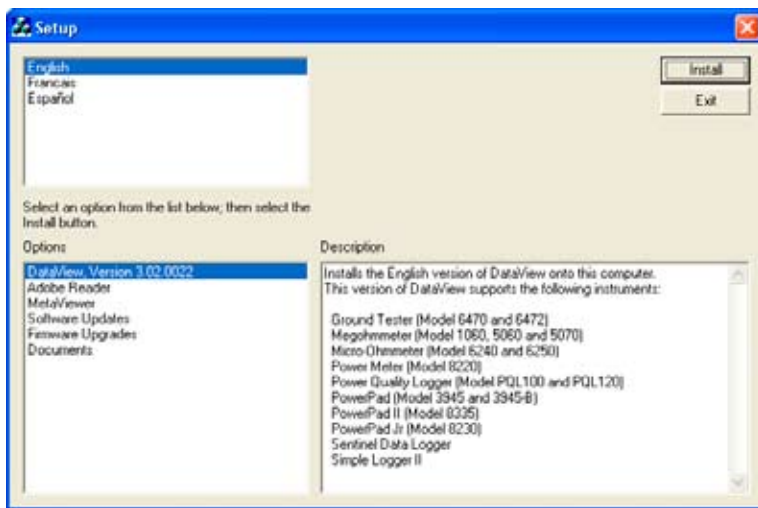

Figure 5-1

There are several different options to choose from. Some options^(*) require an internet connection.

- **DataView, Version x.xx.xxxx** - Installs DataView® onto the PC.
- ***Adobe Reader** - Links to the Adobe® website to download the most recent version of Adobe® Reader to the computer. *Adobe® Reader is required for viewing PDF documents supplied with DataView® that are accessible from the Help menu.*
- **MetaViewer** - The MetaViewer utility program allows a user to view and print .dmf or .emf files generated by DataView® without having DataView® software installed.
- ***Software Updates** - Links to the AEMC® Software Update website to check for new software version releases.
- ***Firmware Upgrades** - Links to the AEMC® Firmware Upgrade website to check for new firmware version releases.
- **Documents** - Shows a list of instrument related documents that you can view. Adobe® Reader is required for viewing PDF documents supplied with DataView®.

3. **DataView, Version x.xx.xxxx** option should be selected by default. Select the desired language and then click on **Install**.
4. The **Installation Wizard** window will appear. Click **Next**.
5. To proceed, accept the terms of the license agreement and click **Next**.
6. In the **Customer Information** window, enter a Name and Company, then click **Next**.
7. In the **Setup Type** window that appears, select the “**Complete**” radio button option, then click **Next**.
8. In the **Select Features** window that appears, select the instrument’s control panel that you want to install, then click **Next**.



The **PDF-XChange** option must be selected to be able to generate PDF reports from within DataView®.

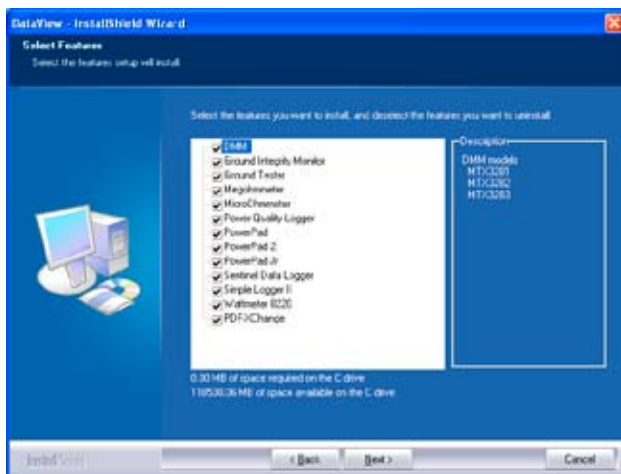

Figure 5-2

9. In the **Ready to Install the Program** window, click on **Install**.
10. If the feature selected for installation requires the use of a USB port, a warning box will appear, similar to Figure 5-3. Click **OK**.

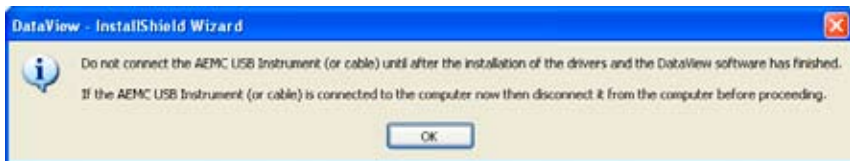

Figure 5-3



The installation of the drivers may take a few moments. Windows may even indicate that it is not responding, however it is running. Please wait for it to finish.

11. When the drivers are finished installing, the **Installation Successful** dialog box will appear. Click **OK**.
12. Next, the **Installation Wizard Complete** window will appear. Click **Finish**.
13. A **Question** dialog box appears next. Click **Yes** to read the procedure for connecting the instrument to the USB port on the computer.



The Set-up window remains open. You may now select another option to download (e.g. Adobe® Reader), or close the window.

14. **Restart** your computer, then connect the instrument to the USB port on the computer.
15. Once connected, the **Found New Hardware** dialog box will appear. Windows will complete the driver installation process automatically.

Shortcuts for DataView® and each instrument control panel selected during the installation process have been added to your desktop.



If you connected your instrument to the computer before installing the software and drivers, you may need to use the **Add/Remove Hardware** utility to remove the instrument driver before repeating the process.

5.2 Connecting the Model 8220 to your Computer

The Model 8220 is supplied with an optically isolated USB interface cable required for connecting the instrument to the computer. This cable (Cat. #2135.41) is equipped with a USB type A on one end, and an optical connector on the other end.

To connect the Model 8220 to your computer:

1. Connect the optical connector end of the cable to the serial port on the side panel of the Model 8220 (see Figure 2-1, item 8)
2. Connect the USB type A end of the cable, to an available USB port on your computer.

You are now ready to use the DataView® software with the instrument.

5.3 Opening the Control Panel

To open the Power Analyzer Control Panel:

- Double-click the **PowerPad** Icon that was created during installation, located on the desktop.
- The **Connection** window will appear (see Figure 5-4).

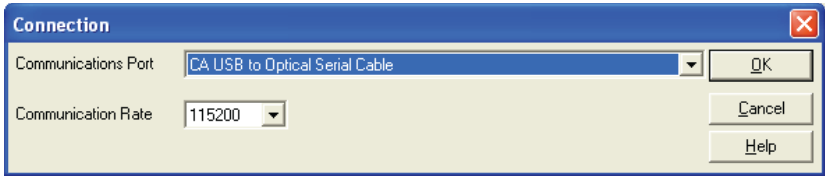

Figure 5-4

Make sure that the communication port displayed in the dialog box matches the port that the serial cable is plugged into. Once the proper communication parameters have been specified, click on OK.



NOTE: The communication rate is determined automatically by DataView® and the Model 8220 (maximum rate is 115.2 kbps).

When a communication link is established, DataView® will automatically identify the instrument that it is connected to and the Control Panel will open (Fig. 5-5).

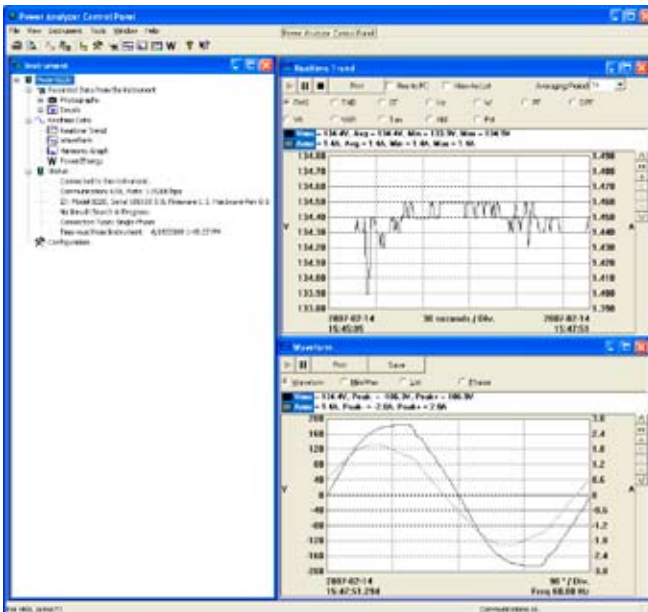

Figure 5-5

A status screen will then appear showing:

- The status of the instrument (on the left side of the screen)
- If DataView® is connected to the Model 8220
- The communications port and speed of the connection
- The model number, serial number, and firmware version
- If a recording is in progress and when it is scheduled to end
- If a delayed recording is scheduled and when it is scheduled to begin
- Real-time waveforms and trend information

If the indicated items are not shown on the screen, select **Restore Default Layout** from the Window menu.

5.4.1 Common Functions

The buttons described here appear on several DataView® Configuration Screens.

- **Re-Read from Instrument:** Reads the current configuration of the attached via the serial cable.
- **Save to File:** Saves the current configuration. This file will reside on the computer's disk drive. Saving different configuration setups can be useful for future functions and tests.
- **Load from File:** Retrieves a saved file from the computer's disk drive to be used in programming the Model 8220.
- **OK:** Closes the dialog box and brings up the Control Panel.
- **Cancel:** Exits without saving configuration.
- **Apply:** Programs the Model 8220 using the current settings without closing the window.
- **Help:** Opens the online Help.

5.4.2 Instrument Configuration

To configure the instrument, go to **Instrument > Configure** or select **Configuration** from the Instrument Tree.

The Configure dialog box lets you configure every aspect of the Model 8220. Each field is identical to the programmable features available from the instrument's front panel itself.

Several of the functions are configured by typing the appropriate value in the field provided. Others are configured by clicking on the appropriate radio button or Icon, such as, selecting the current probe.

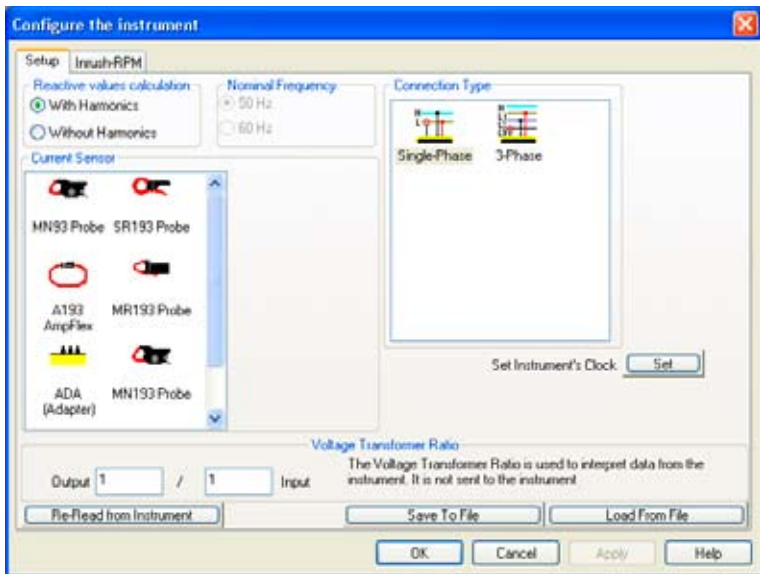

Figure 5-6

The Configure dialog box consists of the following features:

- **Reactive Values Calculation:** With or without harmonics. Applies to VAR calculation.
- **Nominal Frequency:** 50 or 60Hz (displays last detected frequency).
- **Current Sensors:** MN93, MN193, SR193, MR193, AmpFlex®, MiniFlex®, 5A Adapter or SL261. Probes displayed are automatically detected by the instrument. (See § 4.3 for configuration of the MN193 and Adapter box).
- **Connection Type:** Single-Phase or 3-Phase balanced.
- **Voltage Transformer Ratio:** Sets the scale for voltage measurement in cases where measurements are on the secondary side of a transformer and the primary value needs to be displayed. Data is saved on the PC, but not written to the instrument. Corrected values will only be visible in DataView®.
- **Instrument Clock:** Programs the computer's time and date into the configuration of the Model 8220.



NOTE: For detailed instructions and descriptions for any feature in a dialog box, **right-click on the feature** you want information about.

5.4.3 Inrush and RPM Configuration

The Inrush window allows you to set up the criteria for capturing a motor inrush.

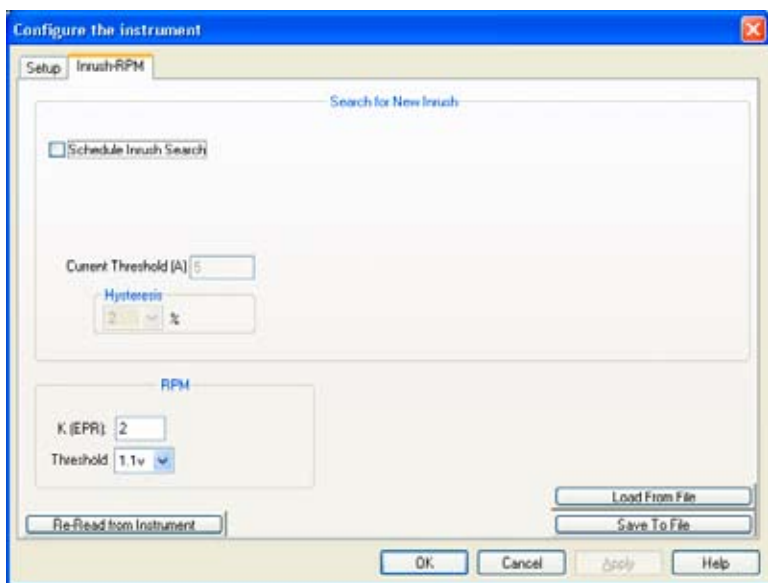

Figure 5-7

Inrush Current:

1. Select the start threshold for current RMS. The inrush recording begins when the ARMS threshold is reached.
2. Select the hysteresis percentage for ending the inrush capture. The inrush recording ends when the current is below the threshold minus the hysteresis percentage, or when the maximum number of datapoints have been captured.

RPM:

The t_{hr} parameter defines the threshold voltage value used to detect an event (pulse on the tachometer signal). Since the signal received by the Model 8220 can be unipolar or bipolar, two types of threshold (0.3 and 1.1V) can be selected. The recommended selection is as follows:

- bipolar signals: 0.3V threshold
- unipolar signals: 1.1V threshold

In both cases, the hysteresis is 0.2 V.

The value is set using the White and Yellow () buttons.

5.5 Real-time Windows

Once setup is complete, different views of real time data and waveforms can be viewed on-screen.

5.5.1 Waveform, Harmonic Bar and Harmonic Text

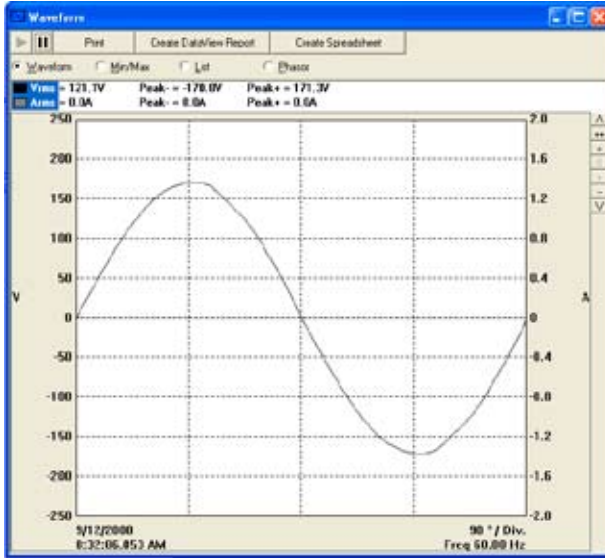

Figure 5-8a

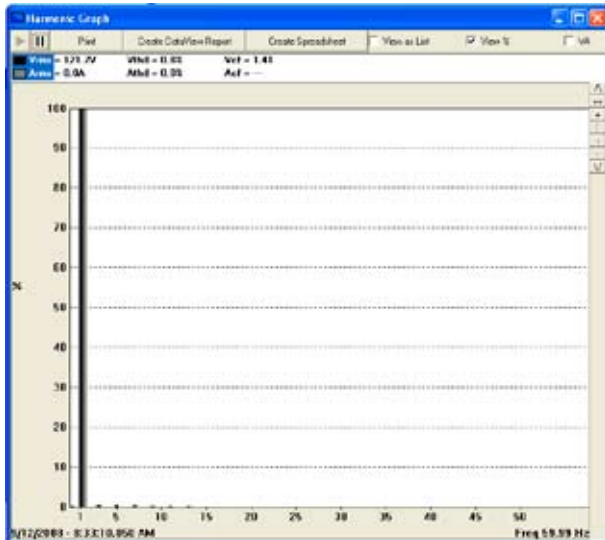

Figure 5-8b

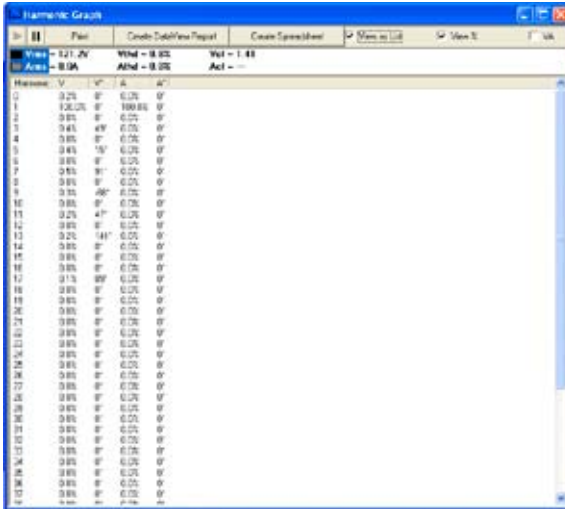

Figure 5-8c

In each Real-time window, you can:

- Select the type of data to review.
- Stop the update with the Hold function.
- Print the selected real-time window.
- Save it to disk. There is a choice of either .dwb (database to be viewed in DataView) or .csv (file to view in a spreadsheet program).

5.5.2 Power/Energy

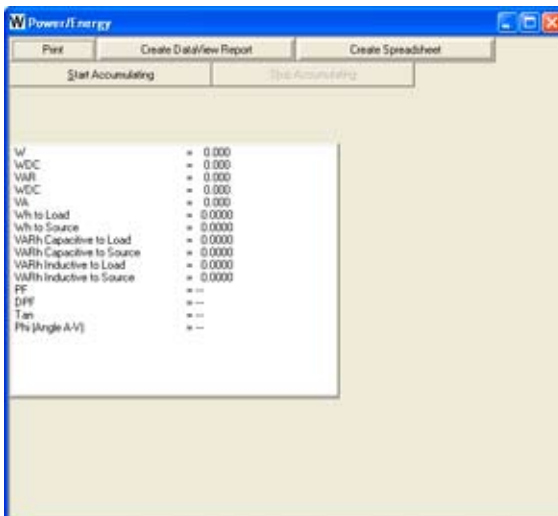

Figure 5-9

The Power/Energy window displays accumulated power and energy data. Accumulated energy data can be started or stopped and the results can be downloaded to a database and viewed on the screen, selected by phase.

5.5.3 Trend

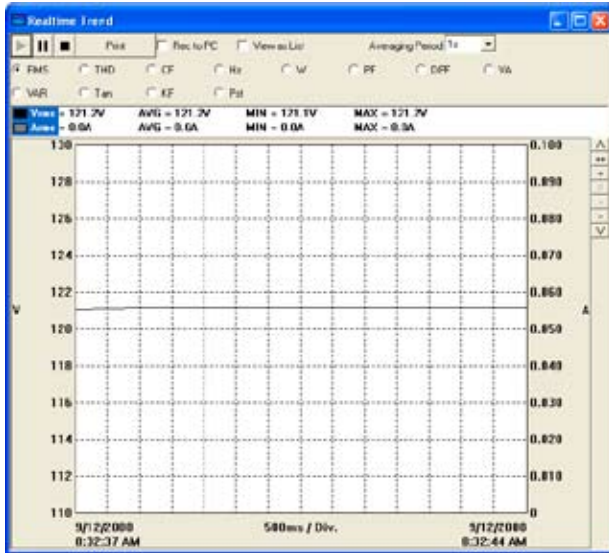

Figure 5-10

Figure 5-10 shows a real-time trend of data from the Model 8220. The data is an average of waveforms downloaded to the PC. There might be 1 waveform per 2.6 seconds. The data is summarized to 1 datapoint every 10 seconds.



NOTE: More data types are downloaded to a database or spreadsheet than what is shown on the screen.

5.6 Downloading Data to Database

- From the **Instrument** menu, select “**Recorded Data**” to download the data recorded in the Model 8220.
 - Select the data you want to Download by clicking on the desired tab (All, Photographs or Inrush), then clicking on the file name.
 - You can then choose to View the data or create a DataView® Report or Spreadsheet by clicking on the appropriate button at the bottom of the dialog box.

5.7 Saving Real-time Measurements

Real-time data received from an instrument can be saved directly into a recording session database. This differs from the process of downloading and saving recorded data in that the measurements are stored on the computer as the instrument measures them. These measurements are not necessarily being stored within the instrument. However, the instrument may be configured to record at the same time real-time measurements are being received from the instrument. In which case, two copies of the measurements will be stored. One copy is stored on the local computer and the other in memory within the instrument.

To Save a Real-time Measurement:

1. From the Realtime Trend window, check the “Rec to PC” checkbox.
2. In the Save As dialog box that appears, specify the type of file to save in the “Save as Type” field. The choices are .dwb (DataView database), .xls (Excel spreadsheet), or .csv (Comma Separated File). Specify the name of the file by typing it into the File name field, select the desired location to save the file, then click Save to save the file.
3. When the “Rec to PC” option is unchecked the file can be opened by selecting **Yes** from the View Saved File dialog box.

To edit the Session Properties, return to the Power Analyzer Control Panel and select **File > Edit Session Properties**.

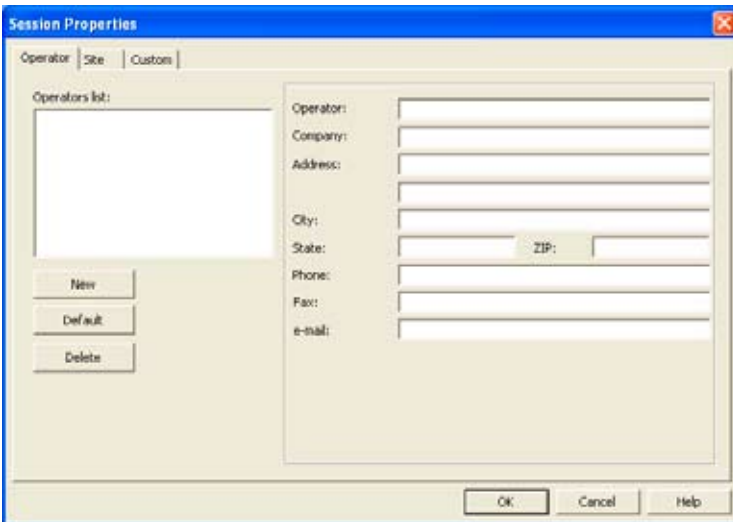

Figure 5-11

The Session Properties dialog box allows you to specify the Operator, Site and Custom parameters that are to be saved with recorded data. These parameters are used when generating reports.

The Operator and Site tabs allow you to maintain lists of operators and sites, saving you time when specifying parameters for reports.

On the left of the Operator and Site tabs is the list of previously defined Operators and Sites. On the right of the Operator and Site tabs are the individual parameters that will be saved in an associated database. Only a single set of operator and site fields are saved in the recording database.

The Custom tab contains a list of user defined parameters. Along side each user defined parameter is a check box. Items that are checked will be added to an associated database. Only a single set of Custom parameters can be maintained (unlike the Operator and Site lists). The Custom tab allows you to specify any user defined parameters (in addition to the comments field of the Site tab) that are to be used in displaying a report.



In addition to the pre-designed report templates, DataView® allows you to totally configure reports to your needs. **Refer to the DataView® HELP file on “Templates” to learn more about templates.**

MAINTENANCE

Use only factory specified replacement parts. AEMC® will not be held responsible for any accident, incident, or malfunction following a repair done other than by its service center or by an approved repair center.

6.1 Changing the Batteries



WARNING:

- When changing the battery, disconnect the instrument from the AC power and any other inputs and turn the equipment off. There must be a delay of at least one minute without the battery being connected.
 - Do not expose the battery to heat exceeding 212°F (100°C).
 - Do not short-circuit the battery terminals.
-

The Model 8220 is powered by six AA (LR6 - NEDA 15A) batteries (standard or rechargeable).

To access the batteries, turn the instrument over and turn the lock one-quarter turn (Figure 6-1, item 2) counter-clockwise using a coin (Figure 6-1, item 3).

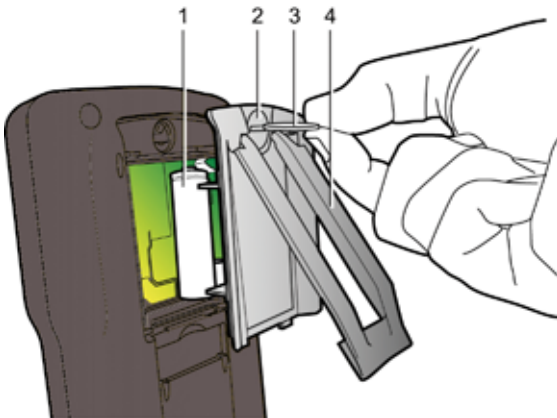

Figure 6-1

6.2 Recharging the Rechargeable Batteries

The Model 8220 may be powered by six rechargeable NiMH batteries (available as an option) having a capacity of at least 1800 mAh.

The instrument does not recharge its own rechargeable batteries. These must be charged on an external charger after removing the batteries from the unit.

6.3 Cleaning



Disconnect the instrument from any source of electricity.

- Use a soft cloth, lightly dampened with soapy water
- Wipe with a damp cloth and then dry with a dry cloth
- Do not splash water directly on the clamp
- Do not use alcohol, solvents or hydrocarbons

APPENDIX A

Mathematical Formulas for Various Parameters

Network Frequency

The sampling is locked to the network frequency so as to provide 256 samples per period (NECHPER) from 40 Hz to 70Hz. This locking is essential for the calculations of the reactive powers, the calculations of levels and angles, and the calculations giving the harmonic magnitudes.

Half-period Voltage and Current RMS Values

$$V_{dem} = \sqrt{\frac{1}{NSHC} \cdot \sum_{n:Zero}^{Next Zero} V[n]^2} \quad \text{Rms voltage}$$

$$A_{dem} = \sqrt{\frac{1}{NSHC} \cdot \sum_{n:Zero}^{Next Zero} A[n]^2} \quad \text{Rms current}$$

NSHC: number of samples per half cycle (between two consecutive zeros)

n: sample (0; 255)

MIN / MAX Values for Voltage and Current

$$V_{max} = \max(V_{dem}), V_{min} = \min(V_{dem})$$

$$A_{max} = \max(A_{dem}), A_{min} = \min(A_{dem})$$

Peak Voltage and Current (Updated on each waveform refresh)

$$V_{pp} = \max(V[n]), V_{pm} = \min(V[n]), n \in [0..NSC-1]$$

$$A_{pp} = \max(A[n]), A_{pm} = \min(A[n]), n \in [0..NSC-1]$$

NSC: number of samples per cycle

Peak Factors for Current and Voltage

$$V_{cf} = \frac{\max(V_{pp}, V_{pm})}{2 \sqrt{\frac{1}{NSC} \cdot \sum_{n=0}^{NSC-1} V[n]^2}} \quad \text{Peak factor voltage}$$

$$A_{cf} = \frac{\max(A_{pp}, A_{pm})}{2 \sqrt{\frac{1}{NSC} \cdot \sum_{n=0}^{NSC-1} A[n]^2}} \quad \text{Peak factor current}$$

1 sec RMS Values for Voltage and Current

$$V_{rms} = \sqrt{\frac{1}{NSS} \cdot \sum_{n=0}^{NSS-1} V[n]^2} \quad \text{Rms voltage}$$

$$A_{rms} = \sqrt{\frac{1}{NSS} \cdot \sum_{n=0}^{NSS-1} A[n]^2} \quad \text{Rms current}$$

NSS: number of samples in a second (multiple of NSC)

Harmonic Calculations

These are done by 1024-point FFT (4 periods) without windowing (cf. IEC 1000-4-7). From the real and imaginary parts, the levels V_{harm} and A_{harm} are calculated (with respect to the RMS value of the fundamental) and the angles V_{ph} and A_{ph} are calculated (phase shift with respect to the fundamental).

$$V_{thd} = \frac{\sqrt{\sum_{n=2}^{50} V_{harm}[n]^2}}{V_{harm}[1]}, \quad A_{thd} = \frac{\sqrt{\sum_{n=2}^{50} A_{harm}[n]^2}}{A_{harm}[1]}$$

The voltage harmonic level (V_{harm}) is multiplied by the current harmonic level (A_{harm}) to calculate the apparent power harmonic level (VA_{harm}). The power harmonic angles are calculated from the difference between voltage harmonic angles and the current harmonic angles.

Different Power Levels 1 Sec in Single-Phase Connection

Active power $W = \frac{1}{NSS} \sum_{n=0}^{NSS-1} V[n] \cdot A[n]$

Apparent power $VA = V_{rms} \cdot A_{rms}$

Reactive power $VAR = \frac{1}{NSS} \sum_{n=0}^{NSS-1} VF[n - NCS / 4] \cdot AF[n]$

or $VAR = \sqrt{VA^2 - W^2}$ if computation method is with harmonics

Different Power Levels 1 Sec in Balanced Three-Phase Connection

Total Active power $W = \frac{-3}{\sqrt{3} \times NSS} \sum_{n=0}^{NSS-1} U[n - NCS / 4] \cdot A[n]$

Total Apparent power $VA = \frac{3}{\sqrt{3}} \cdot U_{RMS} \cdot A_{RMS}$

Total Reactive power $VAR = \sqrt{VA^2 - W^2}$

or $VAR = \frac{3}{\sqrt{3} \times NSS} \sum_{n=0}^{NSS-1} UF[n] \cdot AF[n]$ if computation method is with harmonics

Ratios

$PF = \frac{W}{VA}$ phase power factor

$DPF = \cos(\phi)$ phase displacement factor

$Tan = \tan(\phi)$ phase tangent

$$\cos(\phi) = \frac{\sum_{n=0}^{NSS-1} VF[n] \cdot AF[n]}{\sqrt{\sum_{n=0}^{NSS-1} VF[n]^2} \sqrt{\sum_{n=0}^{NSS-1} AF[n]^2}}$$

Cosine angle between voltage fundamental and phase current

K Factor

$$A_{kf} = \frac{\sum_{n=1}^{n=50} n^2 \cdot Aharm[n]^2}{\sum_{n=1}^{n=50} Aharm[n]^2}$$

Various Types of Energy

$$W_{hc} = \sum_{T_{int}} \frac{W}{3600} \text{ for } W \geq 0 \quad \text{Active energy consumed}$$

$$W_{hg} = \sum_{T_{int}} \frac{-W}{3600} \text{ for } W < 0 \quad \text{Active energy generated}$$

$$VA_{hc} = \sum_{T_{int}} \frac{VA}{3600} \text{ for } W \geq 0 \quad \text{Apparent energy consumed}$$

$$VA_{hg} = \sum_{T_{int}} \frac{VA}{3600} \text{ for } W < 0 \quad \text{Apparent energy generated}$$

$$VAR_{hLc} = \sum_{T_{int}} \frac{VAR}{3600} \text{ for } VAR \geq 0 \text{ and } W \geq 0 \quad \text{Inductive reactive energy consumed}$$

$$VAR_{hLg} = \sum_{T_{int}} \frac{-VAR}{3600} \text{ for } VAR < 0 \text{ and } W < 0 \quad \text{Inductive reactive energy generated}$$

$$VAR_{hCc} = \sum_{T_{int}} \frac{-VAR}{3600} \text{ for } VAR < 0 \text{ and } W \geq 0 \quad \text{Capacitive reactive energy consumed}$$

$$VAR_{hCg} = \sum_{T_{int}} \frac{VAR}{3600} \text{ for } VAR \geq 0 \text{ and } W < 0 \quad \text{Capacitive reactive energy generated}$$

Hysteresis

Hysteresis is a filtering principle, often used after the threshold detection has occurred. A correct setting of hysteresis value will avoid repeated triggering when the measure is varying close to the threshold.

The event detection is activated when the measure is going over the threshold but it can only be deactivated if the measure goes under the threshold minus the value of the hysteresis.

The default hysteresis value is 2% of the reference voltage but it may be set in the range of [1%, 5%] depending of the voltage stability on the system.

Detection of voltage overload

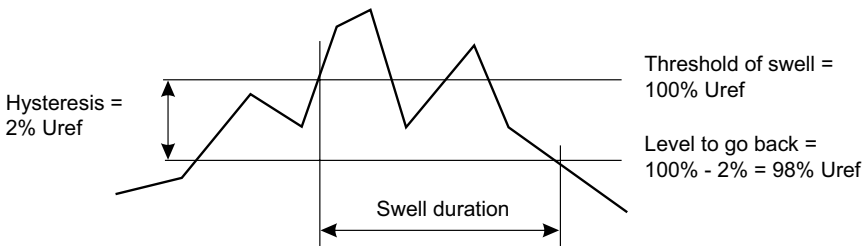

Undervoltage or blackout detection

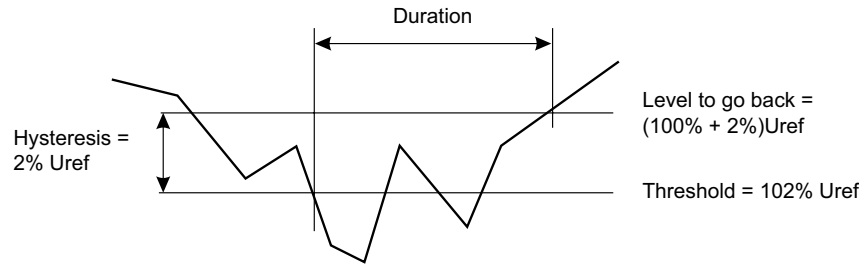

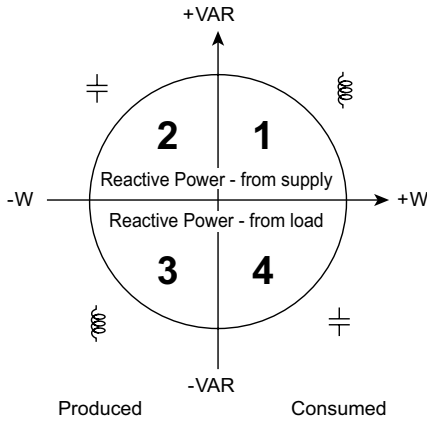

Diagram of 4 Quadrants

Representation of the 4 power quadrants used as a part of the measurement of power .



Saturation of Input Channels

Monitoring of the saturation of input channels is carried out when the instrument is in photograph viewing mode or in the following modes:



No monitoring of the saturation of input channels is carried out when the instrument is in information display mode or in the following modes:



Saturation indicator for voltage input channel

Saturation indicator for current input channel

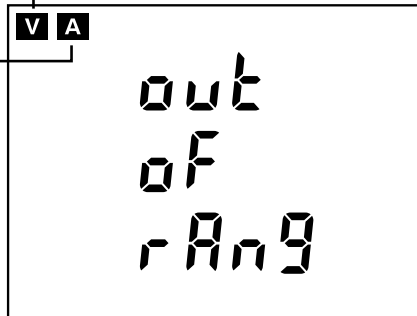

NOTE: It is normal for the above screen to be displayed when the current sensor is installed or removed.

Repair and Calibration

To ensure that your instrument meets factory specifications, we recommend that it be scheduled back to our factory Service Center at one-year intervals for recalibration, or as required by other standards or internal procedures.

For instrument repair and calibration:

You must contact our Service Center for a Customer Service Authorization Number (CSA#). This will ensure that when your instrument arrives, it will be tracked and processed promptly. Please write the CSA# on the outside of the shipping container. If the instrument is returned for calibration, we need to know if you want a standard calibration, or a calibration traceable to N.I.S.T. (Includes calibration certificate plus recorded calibration data).

Ship To: Chauvin Arnoux®, Inc. d.b.a. AEMC® Instruments
15 Faraday Drive
Dover, NH 03820 USA
Phone: (800) 945-2362 (Ext. 360)
(603) 749-6434 (Ext. 360)
Fax: (603) 742-2346 or (603) 749-6309
E-mail: repair@aemc.com

(Or contact your authorized distributor)

Costs for repair, standard calibration, and calibration traceable to N.I.S.T. are available.

NOTE: You must obtain a CSA# before returning any instrument.

Technical and Sales Assistance

If you are experiencing any technical problems, or require any assistance with the proper operation or application of your instrument, please call, mail, fax or e-mail our technical support team:

Chauvin Arnoux®, Inc. d.b.a. AEMC® Instruments
200 Foxborough Boulevard
Foxborough, MA 02035 USA
Phone: (800) 343-1391
(508) 698-2115
Fax: (508) 698-2118
E-mail: techsupport@aemc.com
www.aemc.com

NOTE: Do not ship Instruments to our Foxborough, MA address.

Limited Warranty

The Model 8220 is warranted to the owner for a period of one year from the date of original purchase against defects in manufacture. This limited warranty is given by AEMC® Instruments, not by the distributor from whom it was purchased. This warranty is void if the unit has been tampered with, abused or if the defect is related to service not performed by AEMC® Instruments.

For full and detailed warranty coverage, please read the Warranty Coverage Information, which is attached to the Warranty Registration Card (if enclosed) or is available at www.aemc.com. Please keep the Warranty Coverage Information with your records.

What AEMC® Instruments will do:

If a malfunction occurs within the one-year period, you may return the instrument to us for repair, provided we have your warranty registration information on file or a proof of purchase. AEMC® Instruments will, at its option, repair or replace the faulty material.

**REGISTER ONLINE AT:
www.aemc.com**

Warranty Repairs

What you must do to return an Instrument for Warranty Repair:

First, request a Customer Service Authorization Number (CSA#) by phone or by fax from our Service Department (see address below), then return the instrument along with the signed CSA Form. Please write the CSA# on the outside of the shipping container. Return the instrument, postage or shipment pre-paid to:

Ship To: Chauvin Arnoux®, Inc. d.b.a. AEMC® Instruments
15 Faraday Drive • Dover, NH 03820 USA
Phone: (800) 945-2362 (Ext. 360)
(603) 749-6434 (Ext. 360)
Fax: (603) 742-2346 or (603) 749-6309
E-mail: repair@aemc.com

Caution: To protect yourself against in-transit loss, we recommend you insure your returned material.

NOTE: You must obtain a CSA# before returning any instrument.



05/10

99-MAN 100297 v10