

200A AC Mini Clamp Meter Model MA130

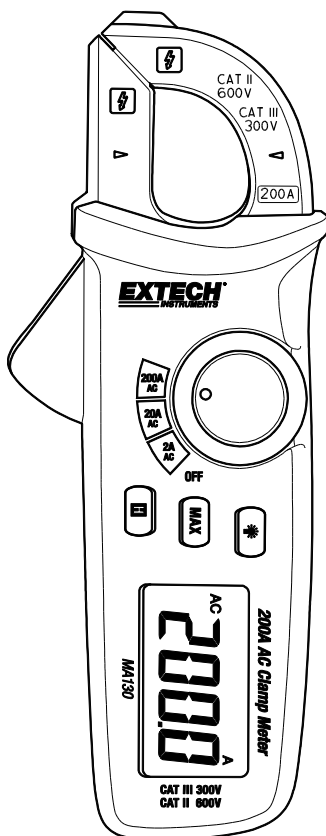

Please visit www.extech.com for user manual translations

Introduction

Thank you for selecting the Extech Instruments 200A AC Mini Clamp Meter. The MA130 measures AC Current in three ranges 2A, 20A, and 200A.

This device is shipped fully tested and calibrated and, with proper use, will provide years of reliable service. Please visit our website (www.extech.com) to check for the latest version of this User Manual, Translations, Product Updates, Product Registration, and Customer Support.

Features

- Measures AC Current in three manually selectable ranges 2A, 20A, and 200A
- 2000 count Backlit LCD display
- Data Hold freezes displayed reading
- MAX function shows highest reading
- Compact 17mm (0.7") jaw size
- Low battery indicator and Auto Power Off feature
- CAT II-600V and CAT III-300V safety rating

Safety Information

To ensure the safe operation and service of the meter, follow these instructions closely. Failure to observe warnings can result in severe injury.



WARNINGS

WARNINGS identify hazardous conditions and actions that could cause BODILY HARM or DEATH.

- Use the meter only as specified in this User Manual to avoid compromising the protections provided by the meter.
- Be sure to use the switch positions, and ranges when taking measurements.
- Do not use clamp meter on a circuit with voltages higher than 600V.
- Use caution working with voltages above 30 VAC RMS, 42 VAC peak, or 60 VDC. These voltages pose a shock hazard.
- To avoid misleading readings that could lead to electric shock and injury, replace the batteries as soon as the low battery indicator is displayed.

- Do not use the meter in the presence of explosive gas or vapor.
- To reduce risk of fire or electric shock, do not use the meter if it is wet and do not expose the meter to moisture.
- Individual protective equipment should be used if HAZARDOUS LIVE parts in the installation where measurements are to be carried out could be accessible.











CAUTIONS

CAUTIONS identify conditions and actions that could cause

DAMAGE to the meter or equipment under test. Do not expose the meter to extremes in temperature or high humidity.

- Do not expose the meter to extremes in temperature or to high humidity.

Safety Symbols that are typically marked on meters and instructions

	This symbol, adjacent to another symbol, indicates the user must refer to the manual or user guide for further information.
	Risk of electrical shock
	Equipment protected by double or reinforced insulation
	Battery symbol
	Conforms to EU directives
	Do not discard this product in household trash
	AC measurement
	Earth ground

PER IEC1010 OVERVOLTAGE INSTALLATION CATEGORY

OVERVOLTAGE CATEGORY I

Equipment of OVERVOLTAGE CATEGORY I is equipment for connection to circuits in which measures are taken to limit the transient over-voltages to an appropriate low level.

Note – Examples include protected electronic circuits.

OVERVOLTAGE CATEGORY II

Equipment of OVERVOLTAGE CATEGORY II is energy-consuming equipment to be supplied from the fixed installation.

Note – Examples include household, office, and laboratory appliances.

OVERVOLTAGE CATEGORY III

Equipment of OVERVOLTAGE CATEGORY III is equipment in fixed installations.

Note – Examples include switches in the fixed installation and some equipment for industrial use with permanent connection to the fixed installation.

OVERVOLTAGE CATEGORY IV

Equipment of OVERVOLTAGE CATEGORY IV is for use at the origin of the installation.

Note – Examples include electricity meters and primary over-current protection equipment

Meter Description

1. Clamp Jaw
2. Protective barrier
3. Clamp jaw trigger open/close
4. Range selection switch
5. Hold button
6. MAX button
7. Backlight button
8. LCD display
9. Indicator for geometric center of clamp head

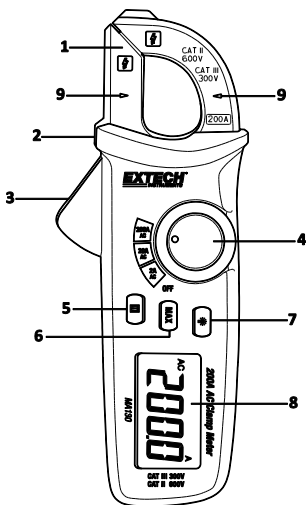

Note: Battery compartment is located on back of meter.

Push-Button Descriptions

(HOLD) button

Short press to freeze displayed reading (**H** icon is visible). Press again to release the reading.

Backlight button

Press and hold for at least 2 seconds to toggle the backlight ON-OFF.

MAX button

Press to view the highest (MAX: maximum) readings.

Operating Instructions



CAUTION: Read and understand all of the Safety statements listed in the safety section of this manual prior to use.

Powering the Meter

1. Turn the rotary function switch to any position to power the meter. Check the batteries if the unit fails to power ON. Refer to the Maintenance section for battery and fuse replacements.
2. Turn the function switch to the OFF position to power OFF the meter.

Automatic Power OFF (APO)

The meter automatically powers off (APO) after approximately 15 minutes of inactivity. In APO mode, turn the rotary switch OFF and then ON to restart the meter. The meter can also be powered on by pressing any button to wake the instrument.

AC Current Measurements



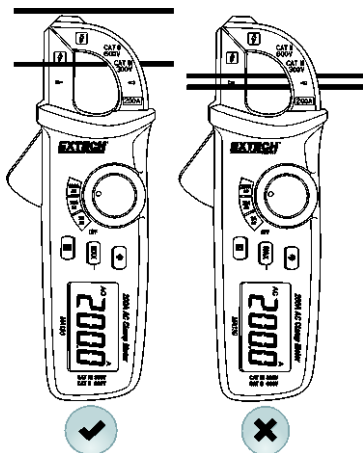

CAUTION: Observe CAT II 600V, CAT III 300V with respect to Earth Ground for the Jaw.

1. Set the Function switch to the 2A, 20A, or 200A range.
2. Press the Trigger to open the clamp jaw.
3. Clamp onto a single conductor (fully enclosing it). See diagram below for proper clamping technique.
4. Use the indicator mark to determine the geometric center of the clamp head (see Meter Description section). Position the measured electrical conductor as close to this geometric center as possible.
5. Do not allow a gap between the two halves of the jaw.
6. Read the ACA value on the LCD.



Data Hold

To freeze the displayed reading on the LCD, long press the Data Hold (**H**) button (the  icon will appear on the display). To release the Data Hold function and return the meter to normal operation, long press the Data Hold (**H**) button again (the  icon will switch off).

MAX Reading

1. Press **MAX** to show the highest reading on the display. The **MAXH** display icon will appear and the reading shown will be the highest reading; updating only when a higher reading is encountered.
2. Press **MAX** again to exit this mode and to view real time readings. The **MAXH** display icon will switch off.

Display Backlight

Long press the backlight button to toggle the display backlight ON or OFF. The backlight automatically dims after 15 seconds.

Maintenance



WARNING: To avoid electrical shock, disconnect the meter from any circuit and turn OFF the meter before opening the case. Do not operate with an open case.

Battery Replacement

1. Turn power OFF.
2. Remove the (1) Phillips head screw that secures the battery compartment on the back of the meter.
3. Open the battery compartment and replace the two (2) 1.5V AAA batteries observing correct polarity.
4. Re-assemble the meter before use.

Safety: Please dispose of batteries responsibly; never dispose of batteries in a fire, batteries may explode or leak. If the meter is not to be used for 60 days or more, remove the battery and store separately.

Never dispose of used batteries or rechargeable batteries in household waste.



As consumers, users are legally required to take used batteries to appropriate collection sites, the retail store where the batteries were purchased, or wherever batteries are sold.

Disposal: Do not dispose of this instrument in household waste. The user is obligated to take end-of-life devices to a designated collection point for the disposal of electrical and electronic equipment.

Cleaning and Storage

Periodically wipe the case with a damp cloth and mild detergent; do not use abrasives or solvents. If the meter is not to be used for 60 days or more, remove the batteries and store separately.

Specifications

Specifications stated for ambient conditions 23°C ±5°C (73.4 °F ±9°F); Relative Humidity < 75%

General Specifications

Display	2000 count LCD with multifunction indicators
Functions	Current (ACA)
Polarity	"-" indicates negative polarity (positive polarity assumed)
Overload Protection	Max. overload protection for clamp head terminal is 200A. O.L. is displayed.
Display rate	2-3 readings/second
Battery	Two 1.5V AAA batteries; Low battery  display
Operating Temperature	0°C to 40°C (32°F to 104°F)
Operating Humidity	0°C to 30°C (32°F to 86°F); <75%RH 30°C to 40°C (86°F to 104°F); < 50%RH
Storage Temperature	-10°C to 50°C (14°F to 122°F)
Altitude	<2000m (6562')
Weight	150g (5.3 oz.) including battery
Dimensions	158 x 60 x 33.5mm (6.2 x 2.4 x 1.3")
Jaw opening	16mm (0.6")
Standards	EN 61010-1, EN61010-2-032, EN61010-2-033; Category II 600V, Category III 300V; pollution degree 2; double insulation
Electromagnetic compatibility	< 1V/m RF field: Overall accuracy = specified accuracy +5% of the range. Unspecified indication for 1V/m RF field.

Range Specifications

Accuracy stated for ambient conditions 23°C ±5°C (73.4°F ±9°F)

AC Current Ranges	Resolution	Accuracy	Overload Protection
2.000 A	1mA	±(4.0%rdg+ 30 digits)	200A AC
20.00 A	10mA	±(3.0%rdg + 20 digits)	200A AC
200.0 A	100mA	±(2.5%rdg + 20 digits)	200A AC

Notes:

Frequency range: 50/60Hz

Maximum overload protection for clamp head terminal is 200A

Accuracy stated for 10~100% of range; < 20-digit residual reading for 2A open circuit.

Copyright © 2016 FLIR Systems, Inc.

All rights reserved including the right of reproduction in whole or in part in any form

ISO-9001 Certified

www.extech.com