



**Thermo Scientific
Laboratory
Temperature
Control Products**

Manual Part Number 011-5013
Rev. 08/03/10

STANDARD Series Thermostats

SC 100

SC 150

SC 150L

ARCTIC Series Refrigerated Bath Circulators



A 5B A 10

A 10B A 25

A 25B A 28

A 28F A 24B

A 40

SAHARA Series Heating Bath Circulators

S 3 S 5T S 6P

S 7 S 12T S 14P

S 13 S 19T S 21P

S 15

S 21

S 30

S45

S49

Visit our Web site at:

<http://www.thermoscientific.com/tc>
Product Service Information, Applications
Notes, MSDS Forms, e-mail.

Thermo Fisher Scientific

25 Nimble Hill Road
Newington, NH 03801
Tel : (800) 258-0830 or
(603) 436-9444
Fax : (603) 436-8411
www.thermoscientific.com/tc

Sales, Service, and Customer Support

25 Nimble Hill Road
Newington, NH 03801
Tel: (800) 258-0830
Sales: 8:00 am to 5:00 pm
Service and Support: 8:00 am to 6:00 pm Monday
through Friday (Eastern Time)
Fax: (603) 436-8411
service.tc.us@thermofisher.com

Dieselstrasse 4
D-76227 Karlsruhe, Germany
Tel : +49 (0) 721 4094 444
Fax : +49 (0) 721 4094 300
info.tc.de@thermofisher.com

NOTE German and French versions of this manual are available in pdf format. Please contact our Sales, Service and Support. ▲

Statement of Copyright

Copyright © 2010 Thermo Fisher Scientific. All rights reserved.

This manual is copyrighted by Thermo Fisher Scientific.

Users are forbidden to reproduce, republish, redistribute, or resell any materials from this manual in either machine-readable form or any other form.

Table of Contents

Preface	i
Compliance	i
WEEE	i
After-Sale Support	ii
Feedback	ii
Warranty	ii
Unpacking	ii
Section 1 Safety	1-1
Safety Warnings	1-1
Section 2 General Information	2-1
Description	2-1
Thermostat Specifications	2-1
Bath/Circulator Specifications	2-3
Wetted Materials	2-4
Section 3 Installation	3-1
Ambient Conditions	3-1
Ventilation	3-2
Electrical Requirements	3-2
External Circulation	3-5
Tubing	3-6
Fluids	3-7
Additional Fluid Precautions	3-8
Filling Requirements	3-11
Draining	3-11
Section 4 Operation	4-1
STANDARD Thermostat	4-1
Setup	4-2
Initial Start Up	4-2
Daily Start Up	4-3
Status Display	4-3
Changing the Setpoint Window	4-4
Menu Displays	4-5
Menu	4-6
Menu Tree	4-7
Editor - Setpoints	4-8
Editor - Auto start	4-9
Settings - Basic settings	4-10
Settings - App. Settings - Limits	4-11

	Settings - App. Settings - Fluids Type.....	4-12
	Settings - Password/Reset	4-12
	System - Adjustment	4-13
	System - Interfaces.....	4-13
	Installation - Information.....	4-14
	Installation - Diagnosis	4-14
	Stopping the Unit.....	4-15
	Power Down.....	4-15
	Shut Down.....	4-15
Section 5	Accessories	5-1
	Lifting Platform Installation.....	5-1
	Immersion Cooler Bridge Installation.....	5-2
	Rack Assembly Instructions.....	5-3
	Serial Communication Adapter.....	5-4
	Tubing.....	5-5
Section 6	Preventive Maintenance.....	6-1
	Cleaning	6-1
	Condenser Fins	6-1
	Testing the Safety Features	6-2
Section 7	Troubleshooting.....	7-1
	Error Displays	7-1
Appendix	Serial Communications.....	A-1

Declaration of Conformity

Return Materials Authorization Form

Warranty

Preface

Compliance

Products tested and found compliant with the requirements defined in the EC Directives as well as Low Voltage Directive (LVD) can be identified by the CE Mark on the rear of the unit. The Declaration of Conformity can be found in the appendix of this manual.

The conformity assessment were performed following defined procedures according to each applicable directive.

The council decision 93/465/EEC shall be authoritative concerning the modules of the various phases of the conformity assessment procedures and the rules for the affixing and use of the CE Mark), which are intended to be used in the technical harmonization directives.

To confirm compliance with the EC-Directive 2004/108/EC Electromagnetic Compatibility (EMC) our products were tested according to the EMC requirements for emission and immunity for electrical equipment for measurement, control and laboratory use.

Some electrical equipment displaying the CE Mark, e.g., monitors or analytical instruments, can be affected if their manufacture accepts interference, e.g., flickering of a monitor, as a minimum operating quality with electromagnetic compatibility. We recommend a minimum distance of approximately one meter from this type of equipment.

For any additional information, refer to the Declaration of Conformity.

Visit www.ul.com/global/eng/pages to view the UL listings for Thermo Fisher Scientific. Reference file #E164214 for these products.

WEEE

This product is required to comply with the European Union's Waste Electrical & Electronic Equipment (WEEE) Directive 2002/96/EC. It is marked with this symbol.



Thermo Fisher Scientific has contracted with one or more recycling/disposal companies in each EU Member State, dispose of or recycle this product through them. Further information on Thermo Fisher Scientific's compliance with these Directives is available at:

www.thermo.com/WEEERoHS

After-sale Support

Thermo Fisher Scientific is committed to customer service both during and after the sale. If you have questions concerning the unit operation, or questions concerning spare parts or Service Contracts, call our Sales, Service and Customer Support phone number, see this manual's inside cover for contact information.



Sample Nameplate

There can be up to three nameplates located on the rear of the unit. Before calling, please obtain the serial number printed on the complete system nameplate located on the upper rear of the bath.

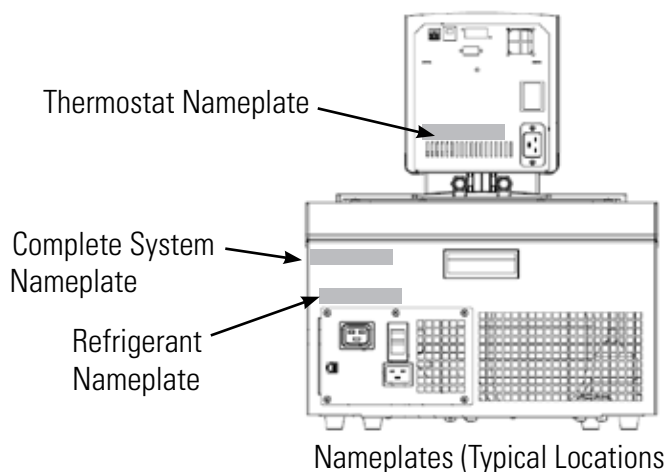

Feedback

We appreciate any feedback you can give us on this manual. Please e-mail us at thermoscientificmanuals@thermofisher.com. Be sure to include the manual part number and the revision date listed on the front cover.

Warranty

Thermo Scientific Laboratory Temperature Control Products have a warranty against defective parts and workmanship for 36 months from date of shipment. See back page of this manual for more details.

Unpacking

Retain all cartons and packing material until the unit is operated and found to be in good condition. If the unit shows external or internal damage contact the transportation company and file a damage claim. Under ICC regulations, this is your responsibility.



Refrigerated units should be left in an upright position for 24 hours before starting. This will ensure the lubrication oil has drained back into the compressor. ▲

Section 1 Safety

Safety Warnings

Make sure you read and understand all instructions and safety precautions listed in this manual before installing or operating your unit. If you have any questions concerning the operation of your unit or the information in this manual, please contact us. See inside cover for contact information.



DANGER indicates an imminently hazardous situation which, if not avoided, *will* result in death or serious injury.



WARNING indicates a potentially hazardous situation which, if not avoided, *could* result in death or serious injury.



CAUTION indicates a potentially hazardous situation which, if not avoided, may result in minor or moderate injury. It is also be used to alert against unsafe practices.



The lightning flash with arrow symbol, within an equilateral triangle, is intended to alert the user to the presence of non-insulated "dangerous voltage" within the unit's enclosure. The voltage magnitude is significant enough to constitute a risk of electrical shock.



This label indicates the presence of hot surfaces.



This label indicates read the manual.

The unit construction provides protection against the risk of electrical shock by grounding appropriate metal parts. The protection will not function unless the power cord is connected to a properly grounded outlet. It is the user's responsibility to assure a proper ground connection is provided. ▲

Never place the unit in a location or atmosphere where excessive heat, moisture, or corrosive materials are present. ▲

Never use corrosive fluids with this unit. Use of these fluids will void the manufacturer's warranty. ▲

Observe all warning labels. ▲

Never remove warning labels. ▲

Refrigerated units should be left in an upright position for 24 hours before starting. This will ensure the lubrication oil has drained back into the compressor. ▲

Other than water, before using any fluid, or when performing maintenance where contact with the fluid is likely, refer to the manufacturer's MSDS and EC Safety Data sheet for handling precautions. ▲

Ensure the tubing you select will meet your maximum temperature and pressure requirements. ▲

Never operate damaged or leaking equipment. ▲

Never operate the unit without fluid in the reservoir. ▲

Never operate the unit or add fluid to the reservoir with panels removed. ▲

Never operate the unit with the immersion circulator removed from the bath. ▲

Do not mount the immersion circulator backwards on the bath; the line cord could contact the reservoir fluid. Ensure the electrical cords do not come in contact with any of the plumbing connections or tubing. ▲

Operate the unit using only the supplied line cords, never operate equipment with damaged cords. ▲

Ensure all communication and electrical connections are made prior to starting the unit. ▲

If the unit's power cord is used as the disconnecting device, it must be easily accessible at all times. ▲

Always turn the unit off and disconnect the supply voltage from its power source before moving the unit or before performing any service or maintenance procedures. ▲

Ensure, that no toxic gases can be generated by the fluid. Inflammable gases can build up over the fluid during usage. ▲

Transport the unit with care. Sudden jolts or drops can damage the unit's components. ▲

Ensure the fluid is at a safe temperature (20°C to 55°C) before handling or draining. ▲

Drain the unit before it is transported and/or stored in near or below freezing temperatures, see Draining in Section 3. ▲

Do not clean the unit with solvents, a soft cloth and water is normally sufficient. ▲

Refer service and repairs to a qualified technician. ▲

Performance of installation, operation, or maintenance procedures other than those described in this manual may result in a hazardous situation and will void the manufacturer's warranty. ▲

Section 2 General Information

Description

The Thermo Scientific STANDARD Series of thermostats are used with refrigerated and heated baths. All thermostats can pump to an external system. All controllers have a digital display and easy-to-use touch pad, five programmable setpoint temperatures, acoustic and optical alarms, and SC 150 and SC 150L units offer adjustable high temperature protection.

The SC 100 is designed to be used only with water or glycol-water. The SC 150 and SC 150L have an independent low liquid level protection, and a design that allows use of different heat transfer liquids, see Section 3.

STANDARD Thermostat Specifications

	SC 100	SC 150	SC 150L
Temperature Range	Ambient +13°C to +100°C Ambient +23°F to +212°F	Ambient +13°C to +150°C Ambient +23°F to +302°F	Ambient +13°C to +150°C Ambient +23°F to +302°F
Temperature Stability	±0.02°C	±0.02°C	±0.02°C
Heater Capacity 230V/115V	2000/1200 Watts	2000/1200 Watts	2000/1200 Watts
Immersion Depth mm inches	75 to 145 3.0 to 5.7	75 to 145 3.0 to 5.7	75 to 190 3.0 to 7.5
Dimensions (H x W x D) mm inches	336 x 138 x 199 13.2 x 5.4 x 7.8	336 x 138 x 199 13.2 x 5.4 x 7.8	384 x 138 x 199 15.1 x 5.4 x 7.8
Net Weight kg lb	3.3 7.3	3.3 7.3	3.3 7.3
Pumping Capacity			
Electrical Requirements (Voltage ±10%)	100 V/50 Hz 100 V/60 Hz or 115 V/60 Hz or 230 V/50 Hz		
USB Interface	No	Yes	Yes

- Performance specifications established in accordance with DIN 12 876 (using water at 70°C).
- Lower temperature ranges available with supplemental cooling.
- The maximum bath wall thickness for thermostats that have a factory installed clamp is 26 mm.
- Thermo Fisher Scientific reserves the right to change specifications without notice.

ARCTIC Refrigerated Bath/Circulator Specifications

Stainless Steel Refrigerated Baths/Circulators					
	A5B	A10B	A25B	A28F	A10
Temperature Range	-5 to 100°C 23 to 212°F	-10 to 100°C 14 to 212°F	-25 to 150°C -13 to 302°F	-28 to 150°C -18 to 302°F	-10 to 100°C 14 to 212°F
Bath Volume liters gallons	12 - 20 3.2 - 5.3	17 - 30 4.5 - 7.9	13 - 21 3.4 - 5.5	6 - 10 1.6 - 2.67	4 - 6 1.1 - 1.6)
Cooling Capacity at 20°C	200 watts	250 watts	500 watts	320 watts	240 watts
Refrigerant	R134a	R134a	R134a	R134a	R134a
Dimensions (H x W x D)* mm inches	471 x 429 x 738 18.5 x 16.9 x 29.0	471 x 429 x 913 18.5 x 16.9 x 36.0	740 x 324 x 541 29.0 x 12.7 x 21.3	520 x 514 x 426 20.5 x 20.2 x 16.8	632 x 220 x 414 24.9 x 8.7 x 16.3
Net Weight kg lb	40.0 88.9	44.5 97.9	42.3 93.1	35.6 78.3	27.5 60.6
Electrical Requirements** (Voltage ±10%)	100 V/50 Hz 100 V/60 Hz or 115 V/60 Hz or 230 V/50 Hz				

Stainless Steel Refrigerated Baths/Circulators				
	A25	A28	A24B	A40
Temperature Range	-25 to 150°C -13 to 302°F	-28 to 150°C -18 to 302°F	-24 to 150°C -11 to 302°F	-28 to 150°C -18 to 302°F
Bath Volume liters gallons	7 - 12 1.8 - 3.2	6 - 10 1.6 - 2.6	16 - 27 4.2 - 7.1	7 - 12 1.8 - 3.2
Cooling Capacity at 20°C	500 watts	320 watts	700 watts	800 watts
Refrigerant	R134a	R134a	R404	R404
Dimensions (H x W x D)* mm inches	711 x 273 x 483 28.0 x 10.7 x 19.0	711 x 273 x 483 28.0 x 10.7 x 19.0	574 x 765 x 610 22.6 x 30.1 x 24.0	749 x 385 x 519 29.5 x 15.1 x 20.4
Net Weight kg lb	36.1 79.5	36.0 79.1	58.6 128.9	55.2 121.5
Electrical Requirements** (Voltage ±10%)	100 V/50 Hz 100 V/60 Hz or 115 V/60 Hz or 230 V/50 Hz			

*Add ~26 mm (1 inch) to D for drain fitting.

**See Section 3 for additional information.

- Thermo Fisher Scientific reserves the right to change specifications without notice.

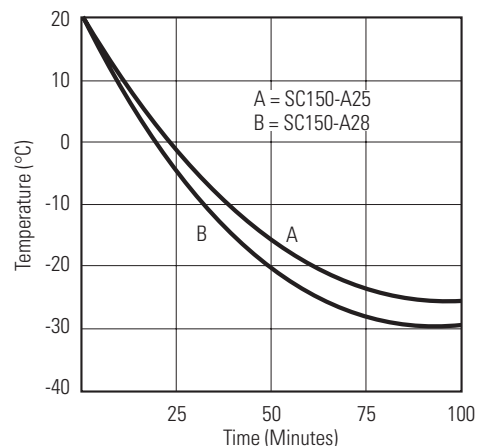

SAHARA Bath/Circulator Specifications

Stainless Steel Baths/Circulators				
	S3	S7	S13	S15
Temperature Range*	Ambient +13 to 150°C Ambient +23 to 302°F	Ambient +13 to 150°C Ambient +23 to 302°F	Ambient +13 to 150°C Ambient +23 to 302°F	Ambient +13 to 150°C Ambient +23 to 302°F
Bath Volume liters gallons	2 - 5 0.6 - 1.3	4 - 7 1.1 - 1.8	7 - 11 1.8 - 2.9	7 - 17 1.8 - 4.5
Dimensions (H x W x D)** mm inches	406 x 235 x 428 16.0 x 9.2 x 16.8	456 x 235 x 428 18.0 x 19.2 x 16.8	456 x 312 x 428 17.9 x 12.6 x 16.8	456 x 381 x 457 17.9 x 15.0 x 18.0
Net Weight kg lb	9.8 21.5	10.6 23.4	12.3 27.0	13.7 30.1

Stainless Steel Baths/Circulators				
	S21	S30	S45	S49
Temperature Range*	Ambient +13 to 150°C Ambient +23 to 302°F	Ambient +13 to 150°C Ambient +23 to 302°F	Ambient +13 to 150°C Ambient +23 to 302°F	Ambient +13 to 150°C Ambient +23 to 302°F
Bath Volume liters gallons	7 - 17 1.8 - 4.5	14 - 24 3.7 - 6.3	30 - 41 7.9 - 10.8	29 - 51 7.7 - 13.5
Dimensions (H x W x D)** mm inches	409 x 381 x 628 16.1 x 15.0 x 24.7	456 x 381 x 628 17.9 x 15.0 x 24.7	556 x 381 x 628 21.9 x 15.0 x 24.7	456 x 579 x 746 17.9 x 22.8 x 29.4
Net Weight kg lb	14.2 31.2	16.5 36.2	20.3 44.7	24.3 53.4

*Lower temperature ranges available with supplemental cooling.

**Add ~26 mm (1 inch) to D for drain fitting.

*** See Section 3 for additional information.

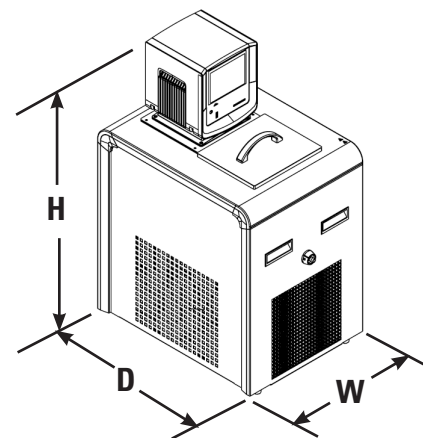
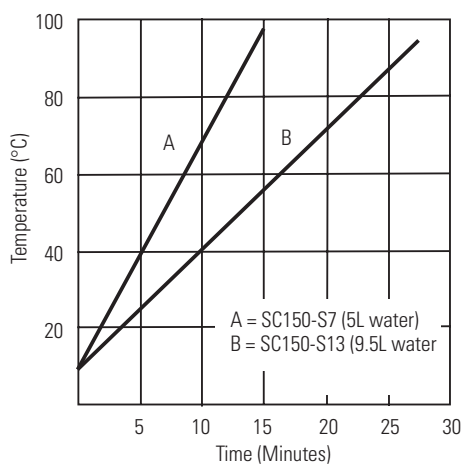

- Thermo Fisher Scientific reserves the right to change specifications without notice.

Transparent Acrylic Baths/Circulators			
	S6T	S12T	S19T
Temperature Range*	Ambient +13 to 60°C Ambient +23 to 140°F	Ambient +13 to 60°C Ambient +23 to 140°F	Ambient +13 to 60°C Ambient +23 to 140°F
Bath Volume liters gallons	4 - 6 1 - 1.6	8 - 12 2.1 - 3.2	12 - 19 3.2 - 5.0
Dimensions (H x W x D) mm inches	360 x 194 x 445 14.2 x 7.6 x 17.5	360 x 360 x 370** 14.2 x 14.2 x 14.6**	360 x 360 x 510** 14.2 x 14.2 x 20.1**
Net Weight kg lb	6.3 13.9	7.3 16.1	8.7 19.1

Polyphenylene oxide (PPO) Baths/Circulators			
	S5P	S14P	S21P
Temperature Range*	Ambient +13 to 100°C Ambient +23 to 212°F	Ambient +13 to 100°C Ambient +23 to 212°F	Ambient +13 to 100°C Ambient +23 to 212°F
Bath Volume liters gallons	3 - 5 0.8 - 1.3	8 - 14 2.1 - 3.7	13 - 21 3.4 - 5.5
Dimensions (H x W x D) mm inches	360 x 187 x 395 14.2 x 7.2 x 15.6	360 x 360 x 450 14.2 x 14.2 x 17.7	360 x 360 x 650 14.2 x 14.2 x 25.6
Net Weight kg lb	5.1 11.2	6.3 13.9	6.6 14.5

*Lower temperature ranges available with supplemental cooling.

**Add ~13 mm (1/2 inch) to D for drain fitting.

***See Section 3 for additional information.

- Thermo Fisher Scientific reserves the right to change specifications without notice.

Wetted Materials

STANDARD Thermostat

Viton
EPDM
Ryton
Ultem
Vectra
Stainless Steel

Stainless Steel Baths/Circulators

Stainless Steel 316
Stainless Steel 304
EPDM (drain fitting)
Ryton
Zotek-N (cover seal)

Transparent Acrylic Baths/Circulators

Poly-acryl

Polyphenylene oxide (PPO) Baths/ Circulators

Polyphenylenoxid

Section 3 Installation

Ambient Conditions

Ambient Temperature Range	5°C to 40°C (41°F to 104°F)
Maximum Relative Humidity	80% at 31°C (88°F)
Operating Altitude	Sea Level to 2000 meters (6560 feet)
Overvoltage Category	II
Pollution Degree	2
Degree of Protection	IP 20

The unit is designed for continuous operation and for indoor use.

The thermostat normally ships with it mounted facing the reservoir. You may change the position $\pm 90^\circ$ by removing thumb screws, no tools are required.



Do not mount it backwards; the line cord could contact the reservoir fluid. ▲

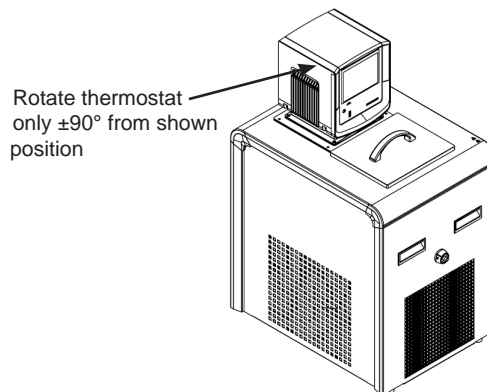

The nozzle at the end of the pump can be repositioned for maximum flow in the bath. When repositioning the head ensure the nozzle is not directed towards a bath wall. There is a second opening on the pump that is capped, remove the cap if that direction is needed.



Never place the unit in a location where excessive heat, moisture, inadequate ventilation, or corrosive materials are present. ▲



Refrigerated units should be left in an upright position for 24 hours before starting. This will ensure the lubrication oil has drained back into the compressor. ▲

Ventilation

The unit can operate with 0 clearance on two exhaust sides as long as the third exhaust side has unrestricted air flow. Blocked ventilation will increase the unit's temperature, reduce its cooling capacity and, on refrigerated units, eventually lead to premature compressor failure.

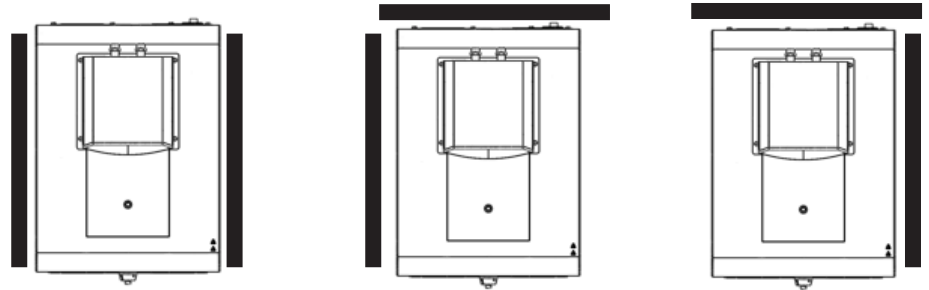

Ventilation Options

Electrical Requirements



The unit construction provides protection against the risk of electrical shock by grounding appropriate metal parts. The protection will not function unless the power cord is connected to a properly grounded outlet. It is the user's responsibility to assure a proper ground connection is provided. ▲

The unit is intended for use on a dedicated outlet. All thermostats are equipped with automatic thermally-triggered 20 Amp circuit protector.

NOTE If the circuit protector activates allow the unit to cool before resetting the protector. Restart the unit. Contact us if it activates again. ▲

The circuit protection is designed to protect the controller, and is not intended as a substitute for branch circuit protection.



If the unit's power cord is used as the disconnecting device, it must be easily accessible at all times. ▲



Operate the unit using only the supplied line cords, never operate equipment with damaged cords. ▲

Refer to the bath nameplate on the rear, upper-left-hand corner of the bath for specific electrical requirements. Voltage deviations of $\pm 10\%$ are permissible. The outlet must be rated as suitable for the total power consumption of the unit, see page 3-4.

NOTE If a bath and thermostat were purchased separately, follow the electrical requirements listed on the bath nameplate. ▲

The following power options are available:

Unit	Volts ¹ /Hertz/Phase	Amps ²	Total Wattage	Plug Type
A10	115/60/1	12	1325	N5-15
	100/50-60/1	12	1135	N5-15
	230/50/1	12	2370	Country Specific
A28	115/60/1	12	1345	N5-15
	100/50-60/1	12	1150	N5-15
	230/50/1	12	2395	Country Specific
A25	115/60/1	12	1345	N5-15
	100/50-60/1	12	1150	N5-15
	230/50/1	12	2395	Country Specific
A5B	115/60/1	12	1325	N5-15
	100/50-60/1	12	1135	N5-15
	230/50/1	12	2370	Country Specific
A10B	115/60/1	12	1325	N5-15
	100/50-60/1	12	1135	N5-15
	230/50/1	12	2370	Country Specific
A25B	115/60/1	12	1345	N5-15
	100/50-60/1	12	1150	N5-15
	230/50/1	12	2395	Country Specific
A28F	115/60/1	12	1325	N5-15
	100/50-60/1	12	1135	N5-15
	230/50/1	12	2370	Country Specific
A40	115/60/1	16	1525	N5-20
	100/50-60/1	16	1660	N5-20
	230/50/1	12	2600	Country Specific
A24B	115/60/1	16	1525	N5-20
	100/50-60/1	16	1660	N5-20
	230/50/1	12	2600	Country Specific
All Heated Baths/Circulators	115/60/1	12	1300	N5-20
	100/50-60/1	12	1000	N5-20
	230/50/1	12	2135	Country Specific

- 1. Volts ± 10%
- 2. Maximum amp draw

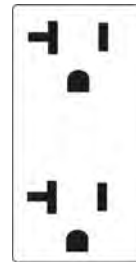

20 Amp Outlet
(16 Amp)

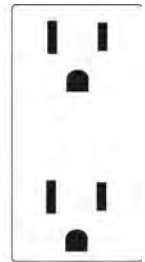

15 Amp Outlet
(12 Amp)



For refrigerated baths:

Ensure all communication and electrical connections are made prior to starting the unit. ▲

- Install the power cord from the connector on the rear of the controller, A, to the connector on the rear of the refrigerated bath, B.
- Connect the bath's power cord, C, to a grounded power outlet.

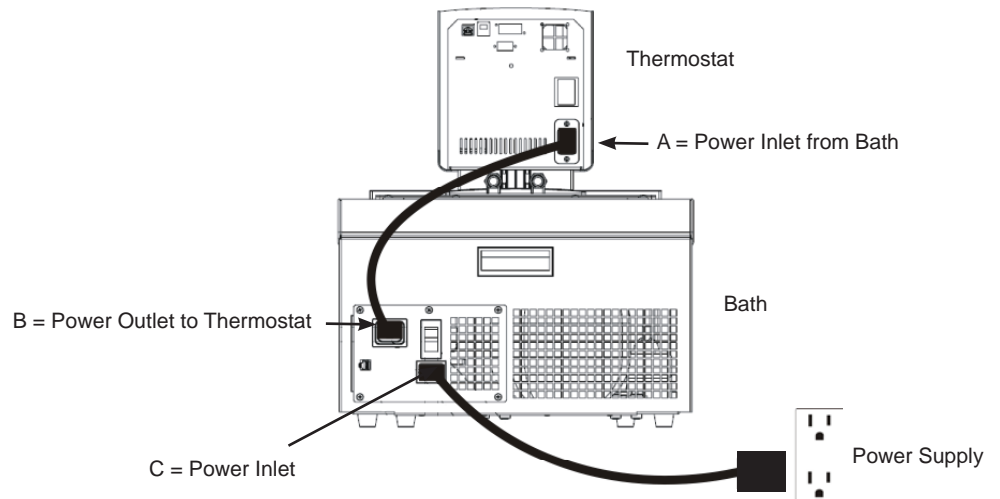

For refrigerated baths, never connect controller power inlet, A, to a power outlet. Never connect power outlet, B, to anything but a thermostat. ▲



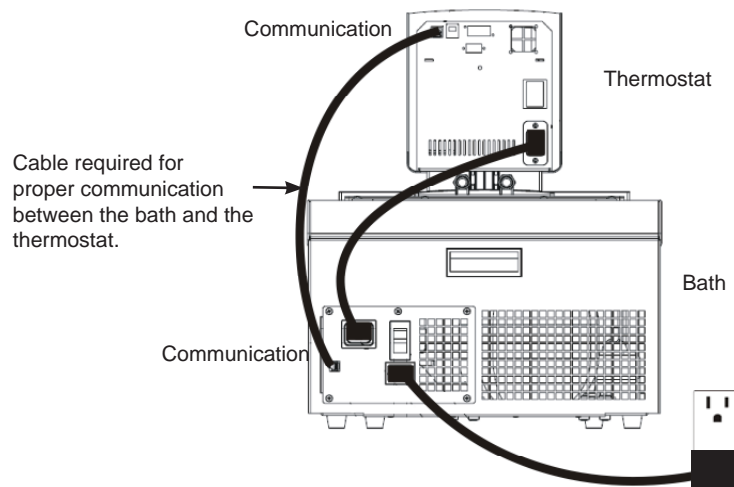

Ensure the electrical cords do not come in contact with any of the plumbing connections or tubing. ▲

- Install the supplied communications cable between the thermostat and the bath RJ45 connectors (similar to Ethernet).



External Circulation

The plumbing connections for external circulation are located on the rear of the thermostat.  is the return flow from the external application.  is the outlet flow to the external application (supply side). The connections are 16 mm O.D. Remove the union nuts and plates to install the 8 mm or 12 mm hose barbs and clamps supplied with the unit.



Tubing Requirements



Ensure none of the tubing comes in contact with the power cord. ▲

Tubing is normally used to connect the pump to an external application.

NOTE Cap the pump nozzle with the supplied fitting for maximum pressure to the external application, it may be necessary to remove the thermostat from the bath to access the nozzle. ▲

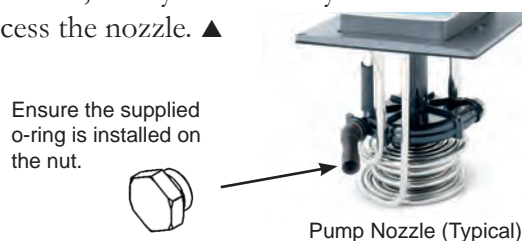

NOTE The maximum allowable length of tube depends largely on the size, form and material of the external vessel. The length of tube and its diameter, combined with the circulating capacity, have a large effect on the temperature stability. Whenever possible, use a wider tube diameter and place the application as close as possible to the circulator. ▲



Extreme operating temperatures will lead to extreme temperatures on the tube surface, this is even more critical with metal nozzles. ▲

- the required tube material depends on the heat transfer liquid used
- tubes must not be folded or bent
- after prolonged use, tubes may become brittle or they may get very soft, check them on a regular basis and replace if necessary
- secure all tube connections using clamps

When using the internal bath only, the plumbing connections can be closed with the supplied plate and union nuts.

Tubing

Tubing for Thermo Scientific temperature control systems is optional. Tubing is available in lengths of 0.5, 1.0 and 1.5 meters. Couplings for connecting tubes are also available. The smallest opening inside the metal tubes is 10 mm. The metal tubing is provided with coupling nuts (M16 x 1, DIN 12 879, part 2) at either end.

Please select the proper tubing from the table shown in Section 5.



Ensure the tubing you select will meet your maximum temperature and pressure requirements. ▲

Plastic and rubber tubing

If other plastic and rubber tubes are used, ensure that the tubes selected are fully suitable for the particular application, i.e., that they will not split, crack or become disengaged from their connections.

Connect the tubing using the supplied tube fittings for 8 or 12 mm i.d. They are attached to the plumbing connections with a supplied coupling nut.

We highly recommend using foam rubber insulation on the tubing and the fittings.

Metal tubing

Thermo Scientific metal tubing (stainless steel insulated) offers a particularly high degree of safety and is suitable for both low and high temperatures/liquids.

The metal tubing is attached directly to the plumbing connections, gaskets are not required.



Do not subject tubing to mechanical strain and ensure any specified bend radius is not exceeded. ▲

Fluids



The user is always responsible for the fluid used. Never use corrosive fluids with this unit. ▲



Never use 100% glycol. ▲



Handling and disposal of liquids other than water should be done in accordance with the fluid manufacturers specification and/or the MSDS for the fluid used. ▲



Always adjust the unit's software to the fluid used, see Section 4. ▲



When using water above 80°C closely monitor the fluid level, frequent top-offs will be required. It will also create steam. ▲



Water/glycol mixtures require top-offs with pure water, otherwise the percentage of glycol will increase resulting in high viscosity and poor performance. ▲

Thermo Fisher Scientific takes no responsibility for damages caused by the selection of an unsuitable bath fluid.

Unsuitable bath fluids are fluids which:

- are very highly viscous (much higher than 30 mPas at the respective working temperature)
- have corrosive characteristics or
- tend to break down at high temperatures

For fluid selection consider application requirements, operating temperature range, material compatibility, safety concerns, and environmental issues.

5°C to 95°C — Distilled Water or Deionized Water (up to 3 MΩ-cm)

Normal tap water leads to calcareous deposits necessitating frequent unit decalcification, see table on next page.

Calcium tends to deposit itself on the heating element. The heating capacity is reduced and service life shortened.

-30°C to 80°C — Water with Glycol

Below 5°C water has to be mixed with a glycol. The amount of glycol added should cover a temperature range 5°C lower than the operating temperature of the particular application. This will prevent the water/glycol from gelling (freezing) near the evaporating coil.

Excess glycol deteriorates the temperature accuracy due to its high viscosity.

-40°C to 200°C — SIL180 (SC 150 and SC 150L units only)

SIL180 is suitable for covering nearly the entire range with just one liquid, especially when used with the cooling units.

Unfortunately SIL180 has a wetting tendency necessitating the occasional cleaning of the bath cover.

other temperatures (SC 150 and SC 150L units only)

Thermo Fisher Scientific offers a range of heat transfer fluids for these temperature control applications.

SYNTH 60, SYNTH 200, SYNTH 260: (SC 150 and SC 150L units only)

Synthetic thermal liquid with a medium life span (several months) and little smell annoyance.

SIL 100, SIL 180, SIL 300: (SC 150 and SC 150L units only)

Silicone oil with a very long life span (over 1 year) and negligible smell.

Thermo Fisher heat transfer fluids are supplied with an EC Safety Data Sheet.



Ensure, when selecting the heat transfer fluid, that no toxic gases can be generated. Inflammable gases can build up over the fluid during usage. ▲



Ensure the over temperature cut-off point is set lower than the fire point for the heat transfer fluid selected. ▲



The highest working temperature as defined by the EN 61010 (IEC 1010) must be limited to 25°C below the fire point of the bath fluid. ▲

Additional Fluid Precautions

When working with fluids other than water:

- Do not use any fluid until you have read and understood the label and the Material Safety Data Sheet (MSDS).
- Ensure any fluid residue or any other material is thoroughly removed before filling the unit with a different fluid.
- Always wear protective clothing, especially a face shield and gloves.
- Avoid spattering on any of the unit's components, always *slowly* add fluid. When adding, point the opening of a container away from yourself.
- Use fume hoods.
- Do not allow any ignition sources in the vicinity.

Fire point

Flammable thermal liquids can ignite when a specified temperature is surpassed. The bath liquid is limited to a temperature level 25°C below the fire point as defined by the EN 61010.

Viscosity

For optimum temperature accuracy, it is important that heat transfer liquids have a low viscosity.

Working temperature range

This is the recommended long-term operating range. The maximum viscosity is approximately 5 mPas.

Operating temperature range

Long-term operation is recommended only under certain conditions. The viscosity may rise to a maximum of 30 mPas. The pump capacity will not match specifications.

Heating-up range

Long-term operation is not recommended, the pump motor's excess temperature protection may switch off the pump.

Range of Application	Sil 100	Sil 180	Sil 300	Synth 60	Synth 200	Synth 260
Fire Point °C	>100	>225	>325	70	>235	275
Flash Point °C	57	170	300	59	227	260
Viscosity at 20°C (mPas)	3	11	200	2	100	140
Density at 20°C (kg/dm ³)	0.89	0.93	1.08	0.76	0.86	1.03
Specific heat capacity (kJ/Kg*K)	1.67	1.51	1.56	2.10	1.96	2.00

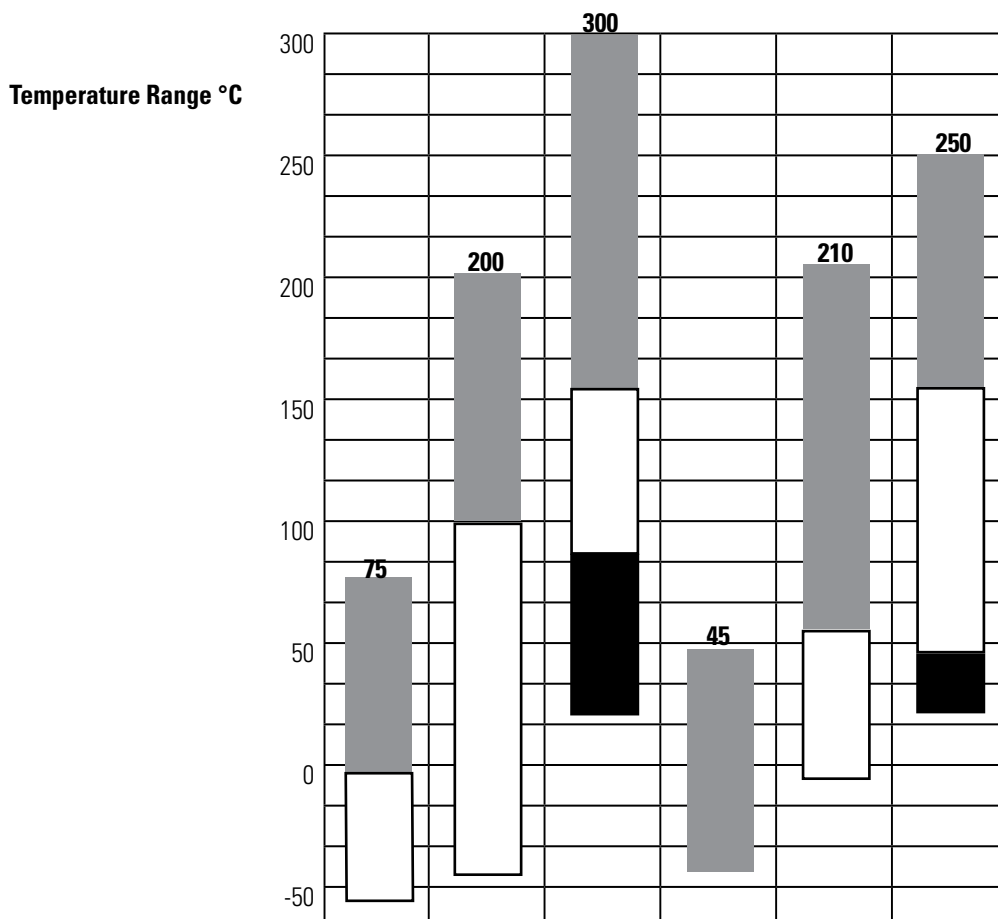

Order Number 10 liter container	999-0202	999-0204	999-0206	999-0210	999-0226	999-0214
Order Number 5 liter container	999-0201	999-0203	999-0205	999-0209	999-0225	999-0213
Color	trans- parent, colorless	trans- parent, colorless	trans- parent, colorless	trans- parent, colorless	transpar- ent, light- brown	trans- parent, yellow
Reacts with	Silicone	Silicone	Silicone	Rubber Silicone	Copper Light metals Bronze	Copper Light metals Bronze

EC-Safety Data Sheets will be delivered together with each container of liquid.

Water Quality and Standards

Process Fluid	Permissible (PPM)	Desirable (PPM)
Microbiologicals		
(algae, bacteria, fungi)	0	0
Inorganic Chemicals		
Calcium	<25	<0.6
Chloride	<25	<10
Copper	<1.3	<1.0
0.020 ppm if fluid in contact with aluminum		
Iron	<0.3	<0.1
Lead	<0.015	0
Magnesium	<12	<0.1
Manganese	<0.05	<0.03
Nitrates\Nitrites	<10 as N	0
Potassium	<20	<0.3
Silicate	<25	<1.0
Sodium	<20	<0.3
Sulfate	<25	<1
Hardness	<17	<0.05
Total Dissolved Solids	<50	<10
Other Parameters		
pH	6.5-8.5	7-8
Resistivity	0.01*	0.05-0.1*

* MΩ-cm (compensated to 25°C)

Unfavorably high total ionized solids (TIS) can accelerate the rate of galvanic corrosion. These contaminants can function as electrolytes which increase the potential for galvanic cell corrosion and lead to localized corrosion such as pitting. Eventually, the pitting will become so extensive that refrigerant will leak into the water reservoir.

As an example, raw water in the United States averages 171 ppm (of NaCl). The recommended level for use in a water system is between 0.5 to 5.0 ppm (of NaCl).

Recommendation: Initially fill the tank with distilled or deionized water. Do not use untreated tap water as the total ionized solids level may be too high. This will reduce the electrolytic potential of the water and prevent or reduce the galvanic corrosion observed.

Filling Requirements

Ensure the reservoir drain port on the front of the unit is *closed* and that all plumbing connections are secure. Also ensure any residue is thoroughly removed before filling the unit.



Before using any fluid refer to the manufacturer's MSDS and EC safety data sheets for handling precautions. ▲

To avoid spilling, place your containers into the bath before filling.



With a low level WARNING the unit continues to run, with a FAULT the unit will shut the refrigeration, pump and heater will shut down, see Section 7. The low level warning for the SC 150 is at approximately 3 cm (1 1/4") below the top, the low level fault is at approximately 7.5 cm (3"). The SC 150L is 4.5 cm (1 3/4") lower for both levels.

Avoid overfilling, oil-based fluids expand when heated. ▲

When pumping to an external system, keep extra fluid on hand to maintain the proper level in the circulating lines and the external system.

NOTE Monitor the fluid level whenever heating the fluid. ▲

Draining



Before draining any fluid refer to the manufacturer's MSDS and EC safety data sheets for handling precautions. ▲



Ensure the fluid is at a safe handling temperature, ~55°C. Wear protective clothing and gloves. ▲

- place a suitable vessel underneath the drain. If desired, attach an 8 mm id tube on the drain.
- *slowly* turn the drain plug until flow is observed.



Turning the drain cap more than 1 1/2 turns will result in the drain cap and fitting coming off the bath.

In this case, the drain fitting can be screwed back into the unit. Attaching the cap onto the fitting will aid in installation. If required, contact us for additional information.



Installed Drain Fitting with Cap Removed

Section 4 Operation

STANDARD Thermostat

The Thermo Scientific STANDARD Series of thermostats have a digital display and easy-to-use touch pad, five programmable set temperatures, acoustic and optical alarms and some units offer adjustable high temperature protection.

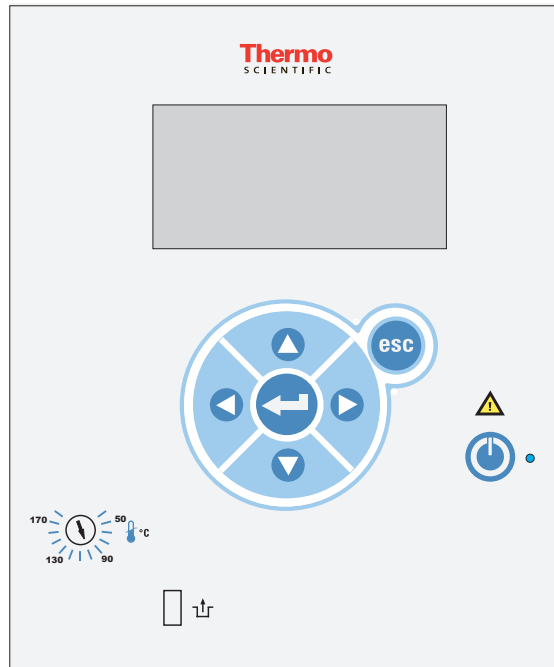

This label indicates read the instruction manual before starting the unit.



Use this button to place the unit in and out of standby, see page 4-3 for more details. The blue LED illuminates when standby is enabled.



Use these navigation arrows to move through the thermostat displays and to adjust values.



Pressing this button once to make changes on the thermostat's display screen. In most cases, pressing it again is required to save the change.



Use this button to cancel any changes and to return the thermostat to its previous display. Canceling a change can only be made before the change is saved. In some cases, it is also used to save changes.



Use the adjacent dial for adjusting the High Temperature Cutout. Not all units are equipped with this feature. Details are explained in Section 6.



High Temperature Cutout reset, details are explained in Section 7.

Setup



Refrigerated units should be left in an upright position for 24 hours before starting. This will ensure the lubrication oil has drained back into the compressor. ▲



Before starting the unit, double check all communication, electrical and plumbing connections. ▲

Initial Start Up

Do not run the unit until fluid is added to the bath. Have extra fluid on hand. If the unit will not start refer to Section 6 Troubleshooting.

- For refrigerated units, place the circuit protector located on the rear of the bath to the **I** position.
- For all units, place the circuit protector located on the rear of the thermostat to the **I** position.
- The thermostat will momentarily display:



Thermo Scientific

- And then the Start Display will appear.

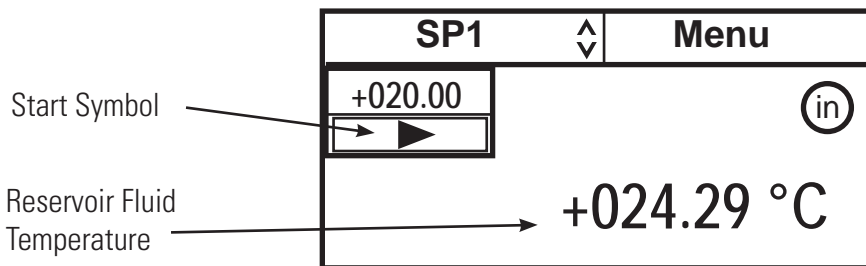

- Ensure the start symbol has a box around it, if not use the arrow keys to navigate to the symbol.
- Press . The unit will start and the start symbol will turn into a stop symbol (■).



NOTE After start up, check all the plumbing connections for leaks. ▲

The **SP1** and **Menu** portions on the top of the display are used to view and/or change the thermostat's settings. They are explained in detail later in this Section.

indicates the thermostat is using its internal temperature sensor.

Daily Start Up



Before starting the unit, double check all communication, electrical and plumbing connections. ▲

The blue LED on the thermostat illuminates to indicate the thermostat is in standby.





If so, press  twice. If Auto start is enabled the unit will start. If Auto start is not enabled, or if the blue LED is not illuminated, use the **Initial Start Up** procedure described on the previous page.

The Auto start feature is described later in this Section.

Status Display

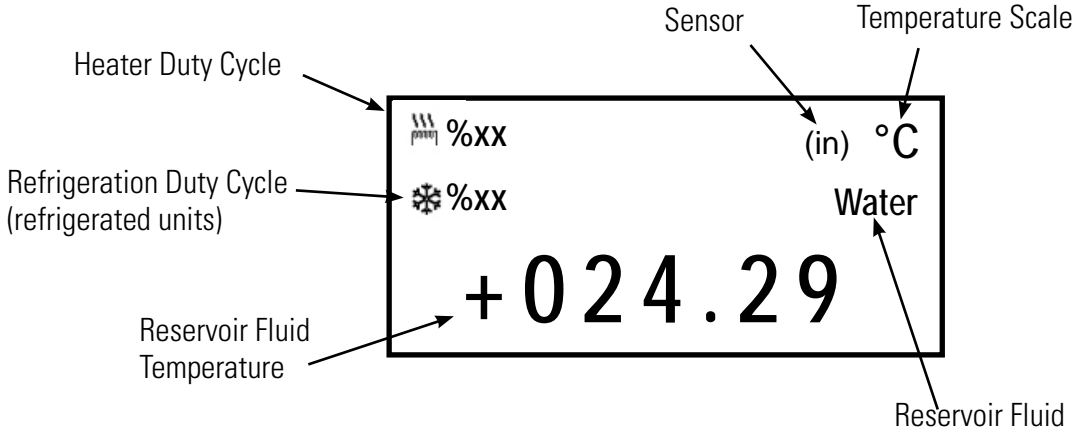
If desired, press  to bring up the Status Display.



If desired, press  again to return to the Start Display.

Changing the Setpoint

NOTE You cannot adjust the setpoint closer than 5°C to either of the fluid's system limits, see Fluids Type in this Section, or beyond the bath's temperature range, see Section 2. For example, an A10 with glycol-water cannot be set lower than -10°C or higher than +95°C. ▲

The Setpoint is the desired reservoir fluid temperature. The thermostat can store up to five setpoints, **SP1** through **SP5**. The procedure for changing the stored setpoint values is discussed later in this Section.

Use the navigation arrows and move to the **SP1** window and then press  to highlight it as shown below.

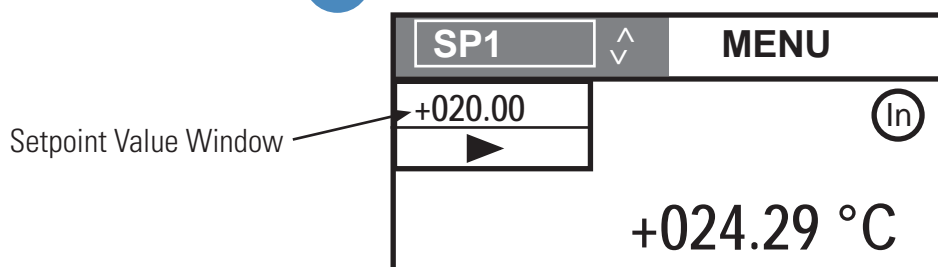

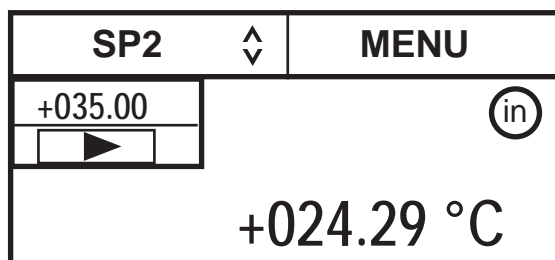

Use the up and down navigation arrows to bring up the desired setpoint and then press .

The display on the Setpoint Value Window will now indicate the corresponding setpoint's stored value.

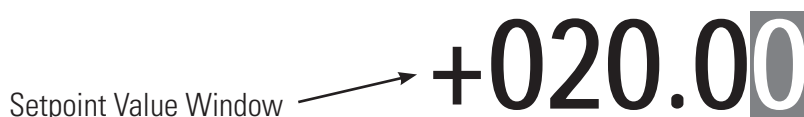

If desired, you can change the displayed setpoint value by using the navigation arrows to highlight the Setpoint Value Window and then pressing . The right-most digit will highlight and flash.



Use the left and right arrows to move the highlight to the desired digit and then use the up and down arrows to change the value. Once all the desired changes are made, press  to save the change.



NOTE Using this procedure also changes the setpoint's stored value. ▲

NOTE The setpoint can be changed with the unit running. ▲

Menu Displays

The thermostat uses menus to view/change the unit's settings.

NOTE The unit does not need to be running to view/change these settings. ▲

For all Menu displays, once  is pressed to change a display, you can press  to return to the previous screen.

1. Use the arrow buttons to highlight **Menu** and the controller brings up the Main Menu Display.

SP1	Menu
Editor	^
Settings	
System	
Installation	v

2. Use the up and down arrow to highlight the desired setting and then press  to bring up additional submenus.

Setpoints	
Auto start	
	v
Menu	

See page 4-8

SP1	Menu
Editor	^
Settings	
System	
Installation	v

Basic settings	
App. Settings	
Password/Reset	
	v
Menu	

See page 4-10

SP1	Menu
Editor	^
Settings	
System	
Installation	v

Adjustment	
Interfaces	
	v
Menu	

See page 4-13

SP1	Menu
Editor	^
Settings	
System	
Installation	v

Information	
Diagnosis	
	v
Menu	

See page 4-14

Since the controller can only display five lines of text at a time, keep pressing the down arrow to highlight **Messages**.

SP1	Menu
Settings	^
System	
Installation	
Messages	v

Warning Messages	^
App Alarm Messages	
Safety FAULT	
	v
Menu	

See Section 7.

Menu

The **Menu** window, at the bottom of all the submenu displays, is another way to return the thermostat back to the Main Menu Display.

1. From any submenu display, use the down arrow button to highlight **Menu**.

Setpoint	^
Auto start	
	v
Menu	

2. Press  to return to the Main Menu Display.

SP1	Menu
Editor	^
Settings	
System	
Installation	v

NOTE  is not operable from the Menu window. ▲

MenuTree

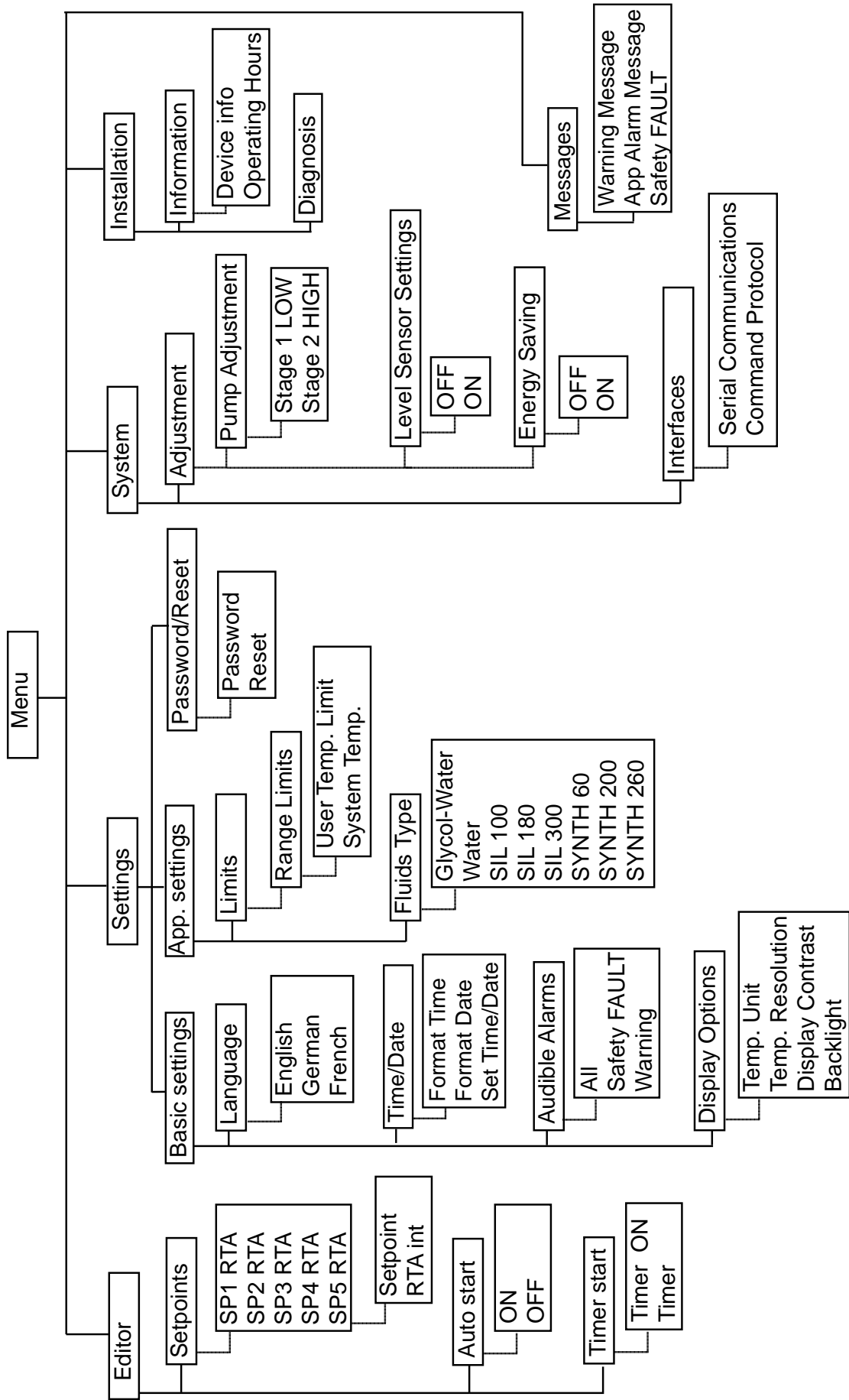

Editor - Setpoints

Editor Setpoints is used to view/adjust the thermostat's five Setpoints and Real Temperature Adjustments (RTA). The display shows the temperature measured by the internal sensor, if this temperature does not accurately reflect the actual temperature in the reservoir an RTA is required. The RTA can be set $\pm 10^{\circ}\text{C}$ ($\pm 18^{\circ}\text{F}$).

As an example, if the thermostat temperature is stabilized and displaying 20°C but a calibrated reference thermometer reads 20.5°C , the RTA should be set to -0.5°C . After you enter a RTA value allow unit to stabilize before verifying the temperature in the bath. **NOTE** If display accuracy is required, we recommend repeating this procedure at various setpoint temperatures and on a regular basis. ▲

NOTE You cannot adjust the setpoint closer than 5°C to either of the fluid's system limits, see Fluids Type in this Section, or beyond the bath's temperature range, see Section 2. For example, an A10 with glycol-water cannot be set lower than -10°C or higher than $+95^{\circ}\text{C}$. ▲

NOTE The setpoint can be changed with the unit running. ▲

1. Use the arrow buttons to highlight **Editor**.

SP1	⬆	Menu
Editor	⬆	▲
Settings		
System		
Installation		▼

2. Press  to display the submenu.

Setpoints	▲
Auto start	
Timer start	
	▼
Menu	

3. With **Setpoints** highlighted, press  to display the list. **NOTE** Use the down arrow to display **SP5**. ▲

SP1	RTA	▲
SP2	RTA	
SP3	RTA	
SP4	RTA	▼
Menu		

4. The Setpoint and RTA are changed using the same procedure. With the desired setpoint highlighted press  to display the submenu.

Setpoint	+XXX.XX	▲
RTA int	+XX.XX	
		▼
Menu		

5. With the desired line highlighted press . A highlight will appear on the last digit.

Setpoint	+XXX.XX	▲
RTA int	+XX.XX	
		▼
Menu		

6. Use the left and right arrows to move the highlight to the desired digit and then use the up and down arrows to change the value. Once all the desired changes are made, press  to save the changes.

Editor - Auto start

Editor Auto start is used to enable/disable auto restart. When enabled, the unit will automatically restart after a power failure or power interruption condition.

1. Use the arrow buttons to highlight **Editor**.

SP1	↑	Menu
Editor	^	
Settings		
System		
Installation	v	

2. Press  to display the submenu.

Setpoints	^
Auto start	
Timer start	
	v
Menu	

3. Use the arrows to highlight **Auto start**.

Setpoints	^
Auto start	
Timer start	
	v
Menu	

4. Press  to display the status.

Auto Start	OFF	^
		v
Menu		

5. Press  to toggle between **ON** and **OFF**.

With the desired setting showing press , or use the **Menu** window, to save and return to the previous display.

Editor - Timer start

Editor Timer start is used to set the timer and adjust the start/stop times. When enabled, the unit will start/stop using the adjusted values. To set the current time/date see the next page.

1. Press  to toggle between **ON** and **OFF**.

2. The second **Timer** is used to set the timer **Start Time/Date** and **Stop Time/Date**.

When enabled highlight the second **Timer**.

Timer	ON	^
Timer		
		v
Menu		

Start Time/Date	^
12:00:00	
01/01/2010	
Stop Time/Date	v
Menu	

Settings - Basic settings

Basic settings is used to view/adjust the thermostat's language, format and set the time and date, enable/disable the audible alarms and configure the display options.

1. Use the navigation arrow buttons to highlight **Settings**.



SP1	↕	Menu
Editor		^
Settings		
System		
Installation		v

2. Press  to display the submenu.

Basic settings	^
App. Settings	
Password/Reset	
	v
Menu	

3. With **Basic Settings** highlighted, press  to display the options.

Language	^
Time/Date	
Audible Alarms	
Display Options	v

4. With **Language** highlighted press . Highlight the desired language. Press .

<input checked="" type="radio"/> English	^
<input type="radio"/> Deutsch	
<input type="radio"/> Francais	
	v
Menu	

5. With **Audible Alarms** highlighted press  to display the screen shown below.

Highlight the desired option and press  again to toggle between **OFF** and **ON**.

All sounds the alarm should either a **Safety** or **WARNING** condition occur.

With the desired setting showing press , or use the **Menu** window, to save and return to the previous display.

All	OFF	^
Safety FAULT	OFF	
WARNING	OFF	
		v
Menu		

6. With **Display Options** highlighted press  to display the screen shown below.

Highlight the desired setting and press  to view the options.

The Temp. Units are °C, °F or °K. Temp. Resolution is either 0.01 or 0.1.

For **Display Contrast** or **Backlight** follow the instructions that appear on the screen. **NOTE Backlight** is either on or off. ▲

Temp. Unit	^
Temp. Resolution	
Display Contrast	
Backlight	v
Menu	

Settings - App. Settings - Limits

App. Settings - Limits is used to view/adjust the thermostat's high and low temperature limits.

NOTE The **User Temp. Limit** is not designed as a safety feature. Use it only as an aid to limit the setpoint range the user can enter. You cannot enter a setpoint that exceeds the high/low limit value. ▲

1. Use the arrow buttons to highlight **App. Settings**.

Basic settings	▲
App. Settings	
Password/Reset	▼
Menu	

2. Press  to display the submenu.

Limits	▲
Fluids Type	▼
Menu	

3. With **Limits** highlighted, press  to display **Range Limits**.

Range Limits	▲
	▼
Menu	

4. Press  and highlight the desired limit.

User Temp. Limit	▲
System Temp. Limit	▼
Menu	

5. Press  and highlight the desired limit.

HTemp LIMIT	xxx.x	▲
LTemp LIMIT	xxx.x	▼
Menu		

6. Follow the same procedure used to change the setpoint to change the limit. You will not be able to enter a setpoint that exceeds the high/low limit value.

HTemp LIMIT	xxx.x	▲
		▼
Menu		

NOTE A **User Temp. Limit** cannot exceed the **System Temp. Limit**. The **System Temp. Limit** is based on the fluid used and it cannot be changed, see next page. ▲

Settings - App. Settings - Fluids Type

App. Settings - Fluids Type is used to identify the type of fluid used. The thermostat uses the fluid type to automatically set certain operating parameters.

NOTE The SC 100 is designed to be used only with water or glycol-water. ▲

1. Use the arrow buttons to highlight **Fluids Type**.

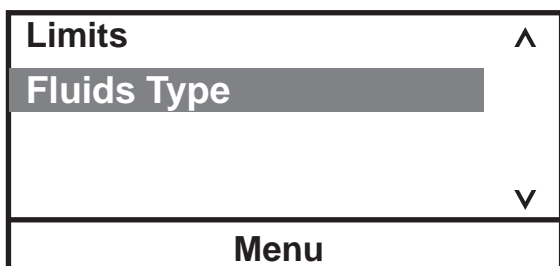

2. Press  to display the submenu.

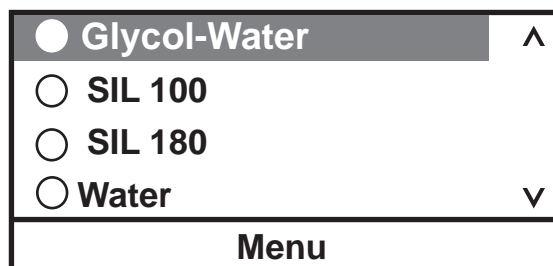

3. Highlight the applicable fluid. **NOTE** Since the controller can display only four fluid types at a time, use the down arrow to display additional fluid options. ▲

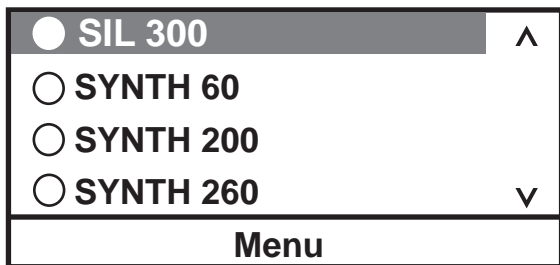

With the desired setting showing press , or use the **Menu** window, to save and return to the previous display.

Fluid system limits	High °C	Low °C
SC 100 units:		
Water	+100	+5
Glycol-Water	+100	-30
Other	+100	-30

SC 150 and SC 150L units:		
Water	+100	+5
Glycol-Water	+100	-30
Other	+100	-30
SIL 100	+75	-28
SIL 180	+150	-28
SIL 300	+150	+80
SYNTH 60	+45	-10
SYNTH 200	+150	+30
SYNTH 260	+150	+45

Settings - Password/Reset

Password/Reset is used to reset the thermostat back to factory preset values. **NOTE** Password is used only by a qualified technician. ▲

System - Adjustment

System Adjustment is used to view/adjust the thermostat's pump speed, and enable/disable the low reservoir fluid level warning message and enable/disable the energy saving feature.

1. Use the arrow buttons to highlight **System**.

SP1	^ v	Menu
Editor		^
Settings		
System		
Installation		v

2. Press  to display the submenu.

Adjustment	^
Interfaces	
	v
Menu	

3. With **Adjustment** highlighted, press  to display the options.

Pump Adjustment	^
Level Sensor Settings	
Energy Saving	
	v
Menu	

4. Highlight the desired feature and press  to view/change the setting.

Stage 1 (LOW)	^
Stage 2 (HIGH)	
	v
Menu	

Pump Adjustment	^
Level Sensor Settings	
Energy Saving	
	v
Menu	

Low Level Warning OFF	^
	v
Menu	

OFF disables the low level warning message, see Section 6, SC 150 only.

Pump Adjustment	^
Level Sensor Settings	
Energy Saving	
	v
Menu	

Energy Saving ON	^
	v
Menu	

The Energy Saving mode is primarily designed for applications running under a stable load. Enabling the mode saves energy by reducing the unit's heater power requirements. This can result in substantial energy savings over the life of the unit.

System - Interfaces

System Interfaces is used to view the serial communications baud rate (19200) or turn the Namur Protocol **ON** or **OFF**. This feature is optional on the SC 150 and SC 150L thermostats. For additional information refer to the Appendix.

Installation - Information

Installation - Information is used to view the thermostat's software version, unit operating hours and heater/pump operating hours.

1. Use the arrow buttons to highlight **Installation**.

SP1	↕	Menu
Editor		^
Settings		
System		
Installation		v

2. Press  to display the submenu.

Information	^
Diagnosis	
	v
Menu	

3. Press  to display the options.

Device info	^
Operating Hours	
	v
Menu	

4. With **Device info** highlighted, press  to display the software version.

Thermo Temp	^

Ver.: x.xxx	
	v
Menu	

5. With **Operating Hours** highlighted, press  to display the list of components.

Power Up	^
Heater	
Pump	
	v
Menu	

6. Highlight the desired component, press  to display its operating hours.

Hours	+XXXXX	^
		v
Menu		

Installation - Diagnosis

Installation - Diagnosis is used by a qualified technician to troubleshoot the thermostat.

Stopping the Unit

Ensure the stop symbol has a box around it, if not use the arrow keys to navigate to the symbol.

Press . The unit will stop and the stop symbol will turn into a start symbol ().

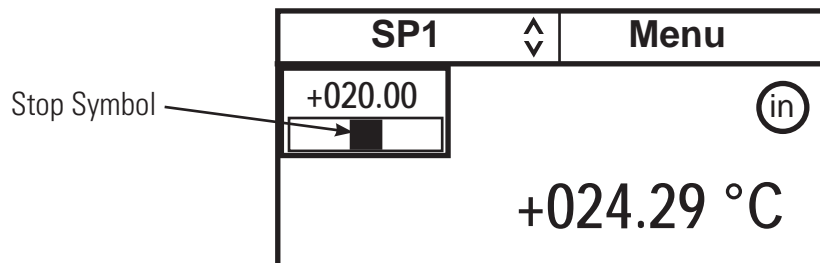

Power Down

Press . The thermostat's screen will go blank and the blue LED will illuminate.

Shut Down

Place the circuit protector on the rear of the thermostat to the  position. The blue LED will extinguish.

On refrigerated units, place the circuit protector on the rear of the bath to the  position.



Using any other means to shut the unit down can reduce the life of the compressor. ▲



Always turn the unit off and disconnect it from its supply voltage before moving the unit. ▲



The circuit protector(s) located on the rear of the component(s) is not intended to act as a disconnecting means. ▲

Restarting

NOTE When quickly restarting refrigerated units, the compressor may take up to 10 minutes before it starts to operate. ▲

Section 5 Accessories

Lifting Platform Installation



Tools required:

- Torx Head screwdriver
- M15 or adjustable wrench

Procedure:

Always turn off the unit and disconnect the power cord from the power source before installing the platform. ▲

1. Undo the four thumbscrews securing the thermostat to the bridge and remove it.
2. Undo the four Torx head screws securing the bridge to the bath and remove the bridge.
3. Secure the stacks to the platform. **NOTE** the long end of the stack is installed into the hole on the platform as shown. ▲
4. Insert the sockets into the holes on the top of the bridge. Secure the sockets to the bridge using a M15 nut on the bottom of each socket.
5. Slide the stacks up and through the sockets on the bridge.
6. Install a male knurled nut into each socket and install a female knurled nut to the top of the stack.
7. Place the assembly in the bath and secure it to the unit using the four Torx head screws.
8. Place the thermostat on the bridge and secure it using the four thumbscrews, hand tight.
9. Place the lifting platform to the desired position and lock it by using the male knurled nuts.

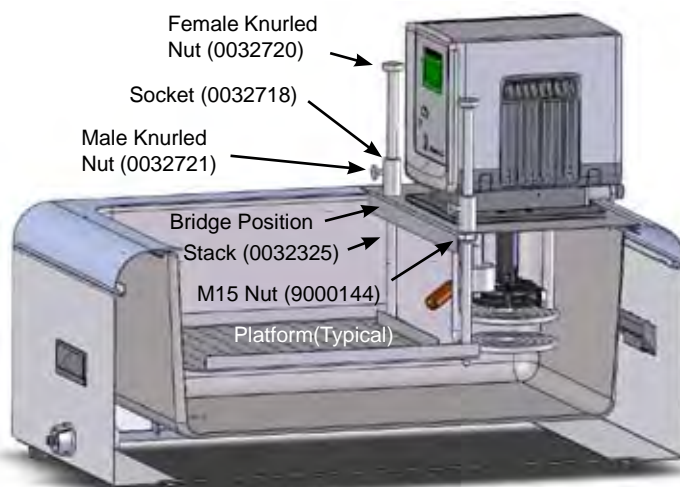

Immersion Cooler Bridge Installation



Tools required:

- Phillips Head screwdriver

Procedure:

Always turn off the unit and disconnect the power cord from the power source before installing the bridge. ▲

1. Undo the four thumbscrews securing the thermostat to the top panel and remove the thermostat.
2. Undo the four Phillips Head screws securing the top panel to the bath and remove it.
3. Turn the old panel over and note the placement of its three gaskets. Using the old panel as a template, install the three supplied gaskets in the same position on the new panel. **NOTE** Place the panels on a soft clean cloth, their stainless steel surfaces are susceptible to scratching. ▲
4. Place the immersion cooler bridge on the bath and secure it to the unit using the four Phillips Head screws.
5. Place the thermostat on the top panel and secure it using the four thumbscrews, hand tight.
6. Remove the two screws securing the "dummy" panel to the immersion cooler bridge.
7. Insert the immersion circulator head through the hole.
8. Secure the head to the top panel using the two supplied panels.

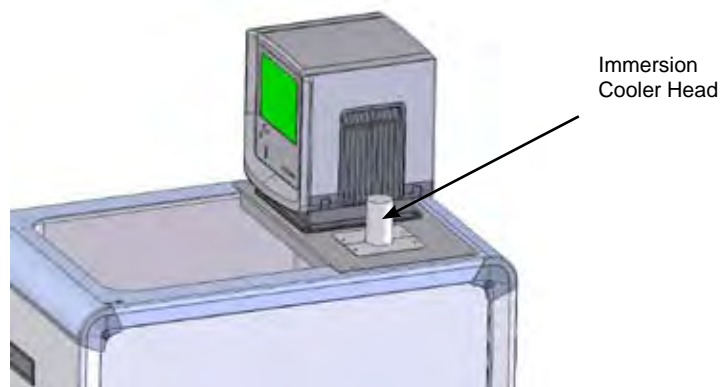

Rack Assembly Instructions

Tools required:

- Phillips Head screwdriver

Procedure:

Note all four support parts are identical, the lower-support is the upper-support rotated 180°.

1. If required, align the top and bottom rack supports to the desired height. Install the rack supports to the base rack using the supplied screws.
2. Install any additional racks, supplied separately, at the desired height.
3. Install optional plastic inserts into the holes as needed.

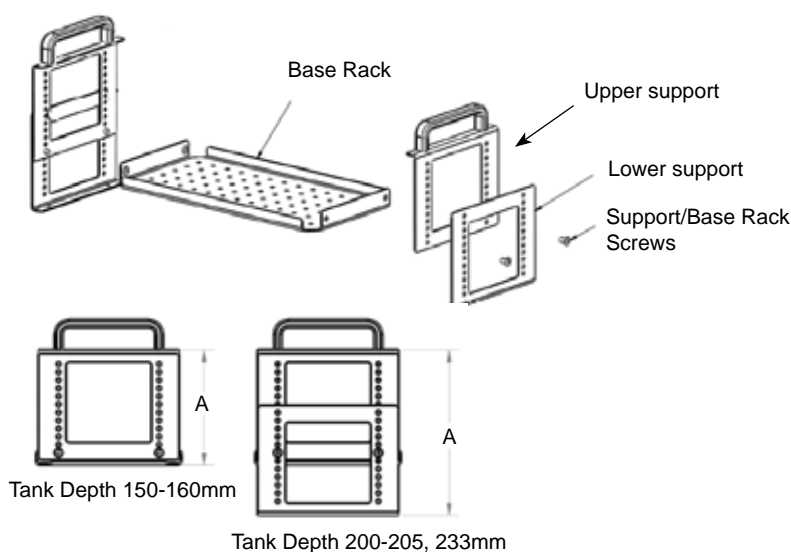

Tank Depth	Dimension A
150-160	114mm
200-205	164MM
233	188MM

Optional Stainless Steel Insert Racks:

A5B, A10B, A24B, S49, S19T, S14P, S21P (283 x 145 mm)

A25B, A410B, S21, S30 (160 x 145 mm)

S13, S12T (160 x 100 mm)

- 10 mm test tube holes
- 16 mm test tube holes
- 25 mm test tube holes
- No holes

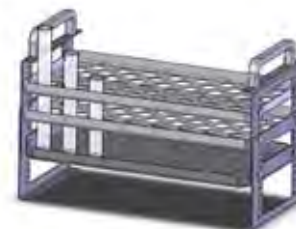

Serial Communications Adapter



Tools required:

- None

Procedure:

Turn off the unit before installing the adapter. ▲

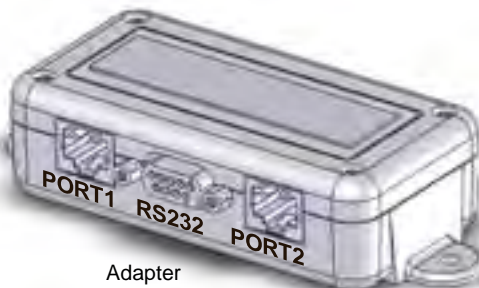

Adapter



Pin #	Function
1	No connection
2	TX
3	RX
4	No connection
5	GND = Signal ground
6 - 9	No connection

Pin #	Function
1-7	No connection
8	T+
9	T-

TX = Transmitted data from thermostat
 RX = Received data to thermostat.

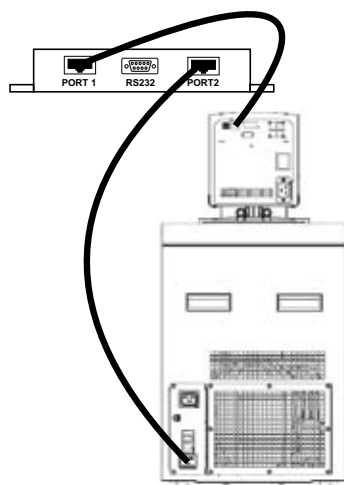

1. If the unit already has a communication cable installed, remove the cable from the rear of the thermostat and plug that cable into PORT 2 on the adapter.
2. Plug the supplied cable into PORT 1 on the adapter and the other end into the thermostat. Regardless of the configuration, the supplied cable *always* goes from the thermostat to PORT 1.
3. Plug the supplied serial communications cable into the communication port on the adapter and then the other end into your computer.
4. If desired, use the supplied Velcro® tape to attach the adapter to a convenient location on the unit.

Tubing

Description	Order-No.
Insulated metal tubes made from stainless steel with M 16 x 1 unions on both ends. -90 to +105 °C temperature range	
100 cm (39") long	333-0578
150 cm (59") long	333-0579
coupling	001-2560
Insulated metal tubing made from stainless steel with M 16 x 1 unions on both ends. -50 to +300 °C temperature range	
50 cm (20") long	333-0292
100 cm (39") long	333-0293
150 cm (59") long	333-0294
tube coupling	001-2560
PVC tubing (water only)	
8 mm i.d. (available per meter)	082-0745
12 mm i.d. (available per meter)	082-0304
Viton tubing -60 to +200 °C temperature range	
8 mm i.d. (available per meter)	082-1214
12 mm i.d. (available per meter)	082-1215
Silicone tubing -30 to +220 °C temperature range (not to be used with any silicone oil, i.e., SIL or Synth 60)	
8 mm i.d. (available per meter)	082-0663
12 mm i.d. (available per meter)	082-0664
Perbunan tubing -40 to +100 °C temperature range	
8 mm i.d. (available per meter)	082-0172
12 mm i.d. (available per meter)	082-0173
Foam rubber insulation for PVC, Viton, Silicone and Perbunan tubes	
8 mm i.d. (available per meter)	806-0373
12 mm i.d. (available per meter)	806-0374
Fittings for plastic tubing	
8 mm i.d.	001-1209
12 mm i.d.	001-1210
Coupling nut	001-0797

Section 6 Preventive Maintenance



Disconnect the power cord prior to performing any maintenance. ▲

Handle the unit with care. Sudden jolts or drops can damage the unit's components. ▲

Cleaning

After time, the unit's stainless steel surfaces may show spots and become tarnished. Normal stainless steel cleaners can be used.

Clean the bath vessel and built-in components at least every time the bath liquid is changed. Use water and a soft cloth.



Do not use scouring powder. ▲

The inside of the bath must be kept clean in order to ensure a long service life. Substances containing acidic or alkaline substances and metal shavings should be removed quickly as they could harm the surfaces causing corrosion. If corrosion (e.g., small rust marks) should occur in spite of this, cleaning with stainless steel caustic agents has proved to be suitable. These substances should be applied according to the manufacturer's recommendations.



For cleaning the baths do not use any substances which contain solvents. ▲

Condenser Fins

In order to maintain the cooling capacity of the unit, clean the fins two to four times per year, depending on the operating environment.

Switch off the unit and unplug the power cord.

For ARCTIC A40

- 1 Remove the condenser panel.
- 2 Clean fins with brush or similar tool.
- 3 Replace the panel.

For all other refrigerated baths:
Clean the fins with compressed air.

For extreme soiling a qualified technician will need to remove the cooling compressor casing.

Testing the Safety Features

The safety features for high temperature protection and low liquid level protection must be checked at regular intervals. The frequency depends on the unit's designated application and the heat transfer fluid used.



High temperature protection

Set a cut-off temperature that is lower than the desired setpoint temperature.

Switch on the circulator and ensure the unit shuts down at the set cut-off temperature.

If the unit does not shut down have the unit checked by a qualified technician.



Acrylic unit's maximum high temperature setting should be limited to the temperature indicated on the label on the front of the bath, 65°C or 80°C. ▲

Low liquid level protection (SC 150 and SC 150L units)

With the unit on, slowly drain the bath fluid (use a drainage tap if necessary) and ensure the unit shuts down.

If not, have the unit checked by qualified a technician.

Section 7 Troubleshooting

Error Displays

The thermostat can display three types of error messages.

Error messages are cleared by pressing the enter key. Once the cause of the error message is identified and corrected, to restart the unit - on units with a reset key, press the reset key full down - and then for all units press the enter key again. If **Auto start** is enabled the unit will restart, if disabled use the Start Up procedure.

Safety Fault Displays

NOTE The heating element, pump and, if applicable, refrigeration shut down with a fault. ▲

A safety fault also sounds the alarm, if enabled.

Low Level Safety FAULT

please remove reason and press ENTER to clear message
--

- SC 150 and SC 150L units
- there is not enough liquid in the bath
- check for leaks, top off if necessary
- fluid has evaporated, top off if necessary
- contact our Sales, Service and Customer Support

Temp. Safety FAULT

please remove reason and press ENTER to clear message Tint = xxx.xx
--

- high temperature protection limit exceeded
- check limit setting
- check fluid selection
- contact our Sales, Service and Customer Support

Indicates internal temperature at time of fault.



Motor FAULT

please remove reason and press ENTER to clear message
--

- it can take over 10 minutes for the motor temperature to get low enough before the unit can be restarted
- if it quickly switches off again, contact our Sales, Service and Customer Support

Refrigeration FAULT

please remove reason and press ENTER to clear message
--

- the refrigeration may need servicing, contact our Sales, Service and Customer Support

Warning Displays

NOTE The heating element and pump continue to run with a warning. ▲
 A warning also sounds the alarm, if enabled.

Low Level Warn.
please remove reason and press ENTER to clear message

- SC 150 and SC 150L units
- check reservoir fluid level
- if reservoir level normal, see Section 3, contact our Sales, Service and Customer Support

Other Errors

A/D Converter FAULT-
please remove reason and press ENTER to clear message

- Analog/Digital converter error, contact our Sales, Service and Customer Support

Bath Communication Error
please remove reason and press ENTER to clear message

- check connections on the back of the unit
- **NOTE** before connecting ensure the power is off. ▲
- contact our Sales, Service and Customer Support

Temp. Sensor int. SHORT!
please remove reason and press ENTER to clear message

- shorted internal temperature sensor
- contact our Sales, Service and Customer Support

Temp. Sensor int. OPEN!
please remove reason and press ENTER to clear message

- open internal temperature sensor
- contact our Sales, Service and Customer Support

Bath not found Non-refrigerated? No Yes
--

- for refrigerated baths, check all communication connections
- **NOTE** before connecting ensure the power is off. ▲
- for non-refrigerated baths, select Yes
- contact our Sales, Service and Customer Support

Appendix **Serial Communications**

1. Terminal settings

- Baud rate: 19200
- Data bits: 8
- Stop bits: 1
- Parity: none
- Flow control: none
- Local echo: on (the thermostat does not send a command echo)

2. General syntax

- Read command:
 - o Command: R<SP><parameter Id><CR><LF>
 - o Return on success: <parameter Id><value><CR><LF>
 - o Return on error: Fxxx<CR><LF>

- Write command:
 - o Command: W<SP><parameter Id><SP><value><CR><LF>
 - o Return on success: \$<CR><LF>
 - o Return on error: Fxxx<CR><LF>

- Remarks:
 - o Parameter Id consists of 2 characters
 - o Decimal point is a point “.”
 - o <SP> ↔ Space character
 - o <CR> ↔ Carriage return character
 - o <LF> ↔ Line feed character
 - o Fxxx ↔ Failure code F000 to F255

- Examples:
 - o W HA 0 85.5 Write parameter HA 0 with the value 85,5
 - o R LA 0 Read parameter LA 0
 - o LA +10.00 LA 0 has a value of 10,00

3. Table of user commands

Description	Syntax	Return on success	Namur notification
Read fluid temperature internal	R T1	T1 <value>	IN_PV_01
Read temperature setpoint	R SP	SP <value>	IN_SP_00
Write temperature setpoint	W SP <value>	\$	OUT_SP_00_<Val>
Read temperature setpoint 1..5	R SP1 R SP2 R SP3 R SP4 R SP5	SP1 <value>	IN_SP_11 IN_SP_12 IN_SP_13 IN_SP_14 IN_SP_15
Write temperature setpoint	W SP1 <value> W SP2 <value> W SP3 <value> W SP4 <value> W SP5 <value>	\$	OUT_SP_11_<Val> OUT_SP_12_<Val> OUT_SP_13_<Val> OUT_SP_14_<Val> OUT_SP_15_<Val>
Read pump speed set point	R PU	PU01 <value>	IN_STATE_13
Write pump speed (0 to 100%)	W P5 <value>	\$	OUT_SP_01_<Val>
Read pump speed SP	R P5	P5 <Value>	IN_SP_01
Read upper temperature range limit	R HA 0	HA <value>	
Write upper temperature range limit	W HA 0 <value>	\$	
Read lower temperature range limit	R LA 0	LA <value>	
Write lower temperature range limit	W LA 0 <value>	\$	
Read upper temperature alarm limit	R HW 0	HW <value>	
Write upper temperature alarm limit	W HW 0 <value>	\$	
Read lower temperature alarm limit	R LW 0	LW <value>	
Write lower temperature alarm limit	W LW 0 <value>	\$	
Start controller	W GO 1	\$	START
Stop controller	W RR -1	\$	STOP
Write internal RTA of setpoint 1	W C1 <value>	\$	
Read internal RTA of setpoint 1	R C1	C1 <value>	
Write internal RTA of setpoint 2	W C2 <value>	\$	
Read internal RTA of setpoint 2	R C2	C2 <value>	
Write internal RTA of setpoint 3	W C3 <value>	\$	
Read internal RTA of setpoint 3	R C3	C3 <value>	
Write internal RTA of setpoint 4	W C4 <value>	\$	
Read internal RTA of setpoint 4	R C4	C4 <value>	
Write internal RTA of setpoint 5	W C5 <value>	\$	
Read internal RTA of setpoint 5	R C5	C5 <value>	

02/10/09

RMA (Return Materials Authorization) Formular / RMA Form

Die Annahme Ihres Gerätes/Ihrer Komponenten in unserem Hause kann nur erfolgen, wenn eine korrekt und vollständig ausgefüllte Erklärung mit einer gültigen RMA-Nr. vorliegt. Ist das nicht der Fall, kommt es leider zu Verzögerungen bzw. muss die Ware zurückgewiesen werden. Bitte nehmen Sie dazu unter support.mc.de@thermofisher.com Kontakt mit unserem Technischen Kunden Support auf.

The acceptance of incoming equipment will only be carried out if a correctly completed declaration with a valid RMA no. has been submitted. Non-completion will cause a delay and the return of the equipment cannot be accepted. Please contact our Technical Support Center under support.mc.de@thermofisher.com.

Diese Erklärung darf nur von autorisiertem Fachpersonal ausgefüllt und unterschrieben werden.

This declaration can only be completed and signed by authorized and qualified staff:

<p>1. Art der Geräte / Description of equipment</p> <p>Gerätetyp: Equipment type:..... Typ-Nr. BOM no.:..... Serien-Nr. Serial no.:..... RMA-Nr. RMA no.:.....</p>	<p>2. Grund der Einsendung / Reason for return</p> <p>.....</p>																					
<p>3. Gerätezustand / Equipment condition</p> <p>Waren die Geräte in Betrieb? / Has the equipment been used?</p> <p><input type="checkbox"/> Ja/Yes: <input type="checkbox"/> Nein/No:</p> <p>Sind die Geräte frei von gesundheitsgefährdenden Schadstoffen? / Is the equipment free of potentially harmful substances?</p> <p><input type="checkbox"/> Ja/Yes: <input type="checkbox"/> Nein/No: (weiter Absatz 4/go to section 4)</p>	<p>4. Einsatzbedingte Kontaminierung / Method of contamination</p> <table style="width: 100%; border-collapse: collapse;"> <thead> <tr> <th style="width: 70%;"></th> <th style="width: 15%; text-align: center;">Ja/Yes</th> <th style="width: 15%; text-align: center;">Nein/No</th> </tr> </thead> <tbody> <tr> <td>- Toxisch/toxic</td> <td style="text-align: center;"><input type="checkbox"/></td> <td style="text-align: center;"><input type="checkbox"/></td> </tr> <tr> <td>- Ätzend/corrosive</td> <td style="text-align: center;"><input type="checkbox"/></td> <td style="text-align: center;"><input type="checkbox"/></td> </tr> <tr> <td>- Mikrobiologisch/ microbial.hazard*)</td> <td style="text-align: center;"><input type="checkbox"/></td> <td style="text-align: center;"><input type="checkbox"/></td> </tr> <tr> <td>- Explosive/explosive*)</td> <td style="text-align: center;"><input type="checkbox"/></td> <td style="text-align: center;"><input type="checkbox"/></td> </tr> <tr> <td>- Radioaktiv/radioactive*)</td> <td style="text-align: center;"><input type="checkbox"/></td> <td style="text-align: center;"><input type="checkbox"/></td> </tr> <tr> <td>- Sonstige Schadstoffe/ other harmful substances</td> <td style="text-align: center;"><input type="checkbox"/></td> <td style="text-align: center;"><input type="checkbox"/></td> </tr> </tbody> </table>		Ja/Yes	Nein/No	- Toxisch/toxic	<input type="checkbox"/>	<input type="checkbox"/>	- Ätzend/corrosive	<input type="checkbox"/>	<input type="checkbox"/>	- Mikrobiologisch/ microbial.hazard*)	<input type="checkbox"/>	<input type="checkbox"/>	- Explosive/explosive*)	<input type="checkbox"/>	<input type="checkbox"/>	- Radioaktiv/radioactive*)	<input type="checkbox"/>	<input type="checkbox"/>	- Sonstige Schadstoffe/ other harmful substances	<input type="checkbox"/>	<input type="checkbox"/>
	Ja/Yes	Nein/No																				
- Toxisch/toxic	<input type="checkbox"/>	<input type="checkbox"/>																				
- Ätzend/corrosive	<input type="checkbox"/>	<input type="checkbox"/>																				
- Mikrobiologisch/ microbial.hazard*)	<input type="checkbox"/>	<input type="checkbox"/>																				
- Explosive/explosive*)	<input type="checkbox"/>	<input type="checkbox"/>																				
- Radioaktiv/radioactive*)	<input type="checkbox"/>	<input type="checkbox"/>																				
- Sonstige Schadstoffe/ other harmful substances	<input type="checkbox"/>	<input type="checkbox"/>																				

***) Mikrobiologisch, explosiv und/oder radioaktiv kontaminierte Geräte und Komponenten werden nur bei Nachweis einer vorschriftsmäßigen Reinigung entgegengenommen!**
We will not accept the return of any equipment that has been radioactively, explosively and/or microbiologically contaminated without written evidence of decontamination.

Art der Schadstoffe oder prozessbedingte, gefährliche Reaktionsprodukte, mit denen die Geräte und Komponenten in Kontakt kamen:

Please list all substances, gases and by-products which may have come into contact with the equipment:

Handelsname/Tradename Produktname/product name Hersteller/manufacturer	Chem.Bezeichnung/ chemical name Chem.Formel/ chem. symbol	Gefahrenklasse/ hazard classification	Maßnahmen bei Freiwerden der Schadstoffe/ precautions associated with substance	Erste Hilfe bei Unfällen/ containment/ first aid measures
1.				
2.				
3.				

Rechtsverbindliche Erklärung / Legally binding declaration

Hiermit versichere ich, dass alle gemachten Angaben korrekt und vollständig sind. Der Versand der kontaminierten Geräte erfolgt gemäß den gesetzlichen Bestimmungen.

I hereby declare that the information supplied on this form is complete and accurate. The dispatch of equipment will be in accordance with the appropriate regulations covering packaging, transportation and labeling of dangerous substances.

Firma/company name:

Adresse/address:

Telefon/phone: Fax:

Ansprechpartner/contact person: E-Mail:

Datum/Date: Firmenstempel/company stamp:

Rechtsverbindliche Unterschrift/legally binding signature:

Warranty

Thermo Fisher Scientific warrants for 36 months from date of shipment the Thermo Scientific STANDARD series of Thermostats, ARCTIC refrigerated bath circulators, and SAHARA heated bath circulators according to the following terms.

Any part of the unit manufactured or supplied by Thermo Fisher Scientific and found in the reasonable judgment of Thermo Fisher to be defective in material or workmanship will be repaired at an authorized Thermo Fisher Repair Depot without charge for parts or labor. The unit, including any defective part must be returned to an authorized Thermo Fisher Repair Depot within the warranty period. The expense of returning the unit to the authorized Thermo Fisher Repair Depot for warranty service will be paid for by the buyer. Our responsibility in respect to warranty claims is limited to performing the required repairs or replacements, and no claim of breach of warranty shall be cause for cancellation or rescission of the contract of sales of any unit. With respect to units that qualify for field service repairs, Thermo Fisher Scientific's responsibility is limited to the component parts necessary for the repair and the labor that is required on site to perform the repair. Any travel labor or mileage charges are the financial responsibility of the buyer.

The buyer shall be responsible for any evaluation or warranty service call (including labor charges) if no defects are found with the Thermo Scientific product.

This warranty does not cover any unit that has been subject to misuse, neglect, or accident. This warranty does not apply to any damage to the unit that is the result of improper installation or maintenance, or to any unit that has been operated or maintained in any way contrary to the operating or maintenance instructions specified in this Instruction and Operation Manual. This warranty does not cover any unit that has been altered or modified so as to change its intended use.

In addition, this warranty does not extend to repairs made by the use of parts, accessories, or fluids which are either incompatible with the unit or adversely affect its operation, performance, or durability.

Thermo Fisher Scientific reserves the right to change or improve the design of any unit without assuming any obligation to modify any unit previously manufactured.

THE FOREGOING EXPRESS WARRANTY IS IN LIEU OF ALL OTHER WARRANTIES, EXPRESSED OR IMPLIED, INCLUDING BUT NOT LIMITED TO WARRANTIES OR MERCHANTABILITY AND FITNESS FOR A PARTICULAR PURPOSE.

OUR OBLIGATION UNDER THIS WARRANTY IS STRICTLY AND EXCLUSIVELY LIMITED TO THE REPAIR OR REPLACEMENT OF DEFECTIVE COMPONENT PARTS AND Thermo Fisher Scientific DOES NOT ASSUME OR AUTHORIZE ANYONE TO ASSUME FOR IT ANY OTHER OBLIGATION.

Thermo Fisher Scientific ASSUMES NO RESPONSIBILITY FOR INCIDENTAL, CONSEQUENTIAL, OR OTHER DAMAGES INCLUDING, BUT NOT LIMITED TO LOSS OR DAMAGE TO PROPERTY, LOSS OF PROFITS OR REVENUE, LOSS OF THE UNIT, LOSS OF TIME, OR INCONVENIENCE.

This warranty applies to units sold in the United States. Any units sold elsewhere are warranted by the affiliated marketing company of Thermo Fisher Scientific. This warranty and all matters arising pursuant to it shall be governed by the law of the State of New Hampshire, United States. All legal actions brought in relation hereto shall be filed in the appropriate state or federal courts in New Hampshire, unless waived by Thermo Fisher Scientific.