



P52590-1



G/6.99 English

**SAFETY INSTRUCTIONS**



1. Do not remove from pressurized lines.
2. Do not exceed maximum temperature/pressure specifications.
3. Pipe fitting must be installed by certified welder only.
4. Do not install/service without following installation instructions (see sensor manual).
5. Wear safety goggles and faceshield during installation/service.
6. Do not alter product construction.
7. Failure to follow safety instructions could result in severe personal injury!

**Maximum Operating Temperature/Pressure:**

+GF+ SIGNET 525 Metalex Sensor with:

- +GF+ SIGNET 526-1XXX Series Saddle Fitting: 21 bar @ 66 °C (300 psi @ 150 °F)
- +GF+ SIGNET 526-2XXX Series Tee & Mini-Tap Fitting: 103 bar @ 149 °C (1500 psi @ 300 °F)



**1. Location of Fitting**

Recommended sensor upstream/downstream mounting requirements.

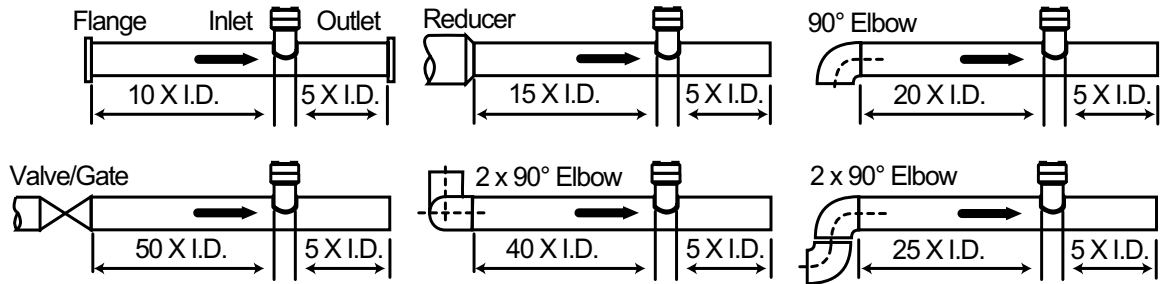

**2. Sensor Mounting Position**

- Horizontal pipe runs: Mount sensor in the upright (0°) position for best overall performance. Mount at a maximum of 45° when air bubbles are present. Do not mount on the bottom of pipe when sediments are present.
- Vertical pipe runs: Sensor must be mounted in lines with UPWARD flow only.

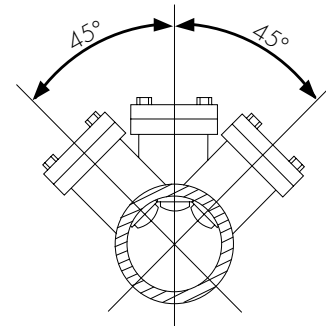

**3. Sensor/Fitting Selection**

The 525 is designed for installation into SCH 40 stainless steel pipes via +GF+ SIGNET Metalex Tee, Mini-Tap or Saddle fittings, see options below:

+GF+ SIGNET Metalex Tee Fittings

Pipe (in.)	Sensor	Fitting	Code
0.50	P525-1	P526-2005	198 840 501
0.75	P525-1	P526-2007	198 840 502
1.00	P525-1	P526-2010	198 840 503

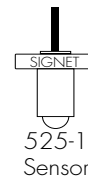

525-1 Sensor

Wetted fitting materials: 316 SS

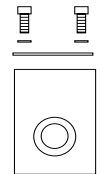

Tee Fitting, hardware included

+GF+ SIGNET Metalex Mini-Tap Fittings

Pipe (in.)	Sensor	Fitting	Code
1.25	P525-2	P526-2012	198 840 519
1.50	P525-2	P526-2015	198 840 520
2.00	P525-2	P526-2020	198 840 521
2.50	P525-2	P526-2025	198 840 522
3.00	P525-2	P526-2030	198 840 523
4.00	P525-2	P526-2040	198 840 524
5.00	P525-2	P526-2050	198 841 525
6.00	P525-2	P526-2060	198 840 526
8.00	P525-2	P526-2080	198 840 527
10.0	P525-2	P526-2100	198 840 528
12.0	P525-2	P526-2120	198 840 529

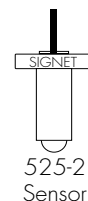

525-2 Sensor

Wetted fitting materials: 316 SS & 347 SS

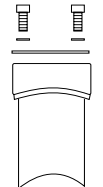

Mini-Tap Fitting, hardware included

**+GF+ SIGNET Metalex Saddle Fittings**

Pipe (in.)	Sensor	Fitting	Code
2.00	P525-3	P526-1020	198 840 510
2.50	P525-3	P526-1025	198 840 511
3.00	P525-3	P526-1030	198 840 512
4.00	P525-3	P526-1040	198 840 513
5.00	P525-3	P526-1050	198 840 514
6.00	P525-3	P526-1060	198 840 515
8.00	P525-3	P526-1080	198 840 515
10.0	P525-3	P526-1100	198 840 516
12.0	P525-3	P526-1120	198 840 518

Wetted fitting materials:  
 Ductile Iron, 347 SS,  
 Carbon steel,  
 Buna-N/Neoprene

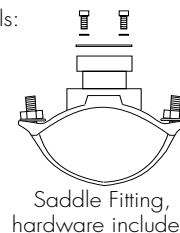
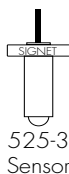

**4. Fitting Installation, Required Hardware**

- +GF+ SIGNET Metalex Tee & Mini-Tap Fittings, P525-2XXX
- 0.5 to 1 inch pipes, P526-2 series fitting required
  - 1.25 to 12 inch pipes: P526-2 series fitting and 27 mm (1-1/16 in.) diameter drill required
  - Mini-Tap fittings are welded onto the pipe and are used with +GF+ SIGNET 525-1 sensors.

- +GF+ SIGNET Metalex Saddle Fitting, P526-1XXX
- 27 mm (1-1/16 in.) diameter drill required

Saddle type fittings are strapped to the pipe and are used with +GF+ SIGNET 525-3 sensors. Welds MUST be made by a certified welder who is licensed to weld stainless steel and other high-carbon grade steels.

**4.1 Installation, Tee & Mini-Tap Fittings**

1. Select an appropriate mounting location as outlined in sections 1 and 2.
2. Depressurize and drain pipe.
3. Use the following welding and installation procedures appropriate for your fitting/pipe size:

+GF+ SIGNET Tee Fittings, 0.5 to 1 inch:

- Insert pipe into fitting socket
- Make sure the pipe is parallel to the bottom of the Mini-Tap fitting.
- Weld pipe into place

- +GF+ SIGNET Mini-Tap Fittings, 1.25 to 12 inch:
- Drill a 27 mm (1-1/16 in.) diameter hole completely through the ONE surface of the pipe. Thoroughly deburr inner and outer edges of hole.
  - Tack weld the Mini-Tap fitting onto the pipe, making sure the hole in the pipe is lined up with the Mini-Tap fitting hole.
  - Weld the Mini-Tap fitting onto the pipe.

**4.2 Installation, Saddle Fittings**

1. Select an appropriate mounting location as outlined in sections 1 and 2.
2. Drill a 27 mm (1-1/16 in.) diameter hole completely through the TOP surface of the pipe. Thoroughly deburr inner and outer edges of hole.
3. Place the Buna-N/Neoprene saddle O-ring over the pipe hole (small hole side towards pipe). Position the saddle fitting over the O-ring, making sure the O-ring centers on the underside fitting ridge. Center saddle fitting and O-ring over the pipe hole, then strap the fitting to the pipe with the two U-bolts. Snug all four nuts in a criss-cross pattern. Using a torque wrench (when possible) torque the U-bolts in a criss-cross pattern to 52 foot-pounds.

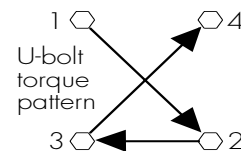

**5. Sensor Installation**

1. Set the gasket supplied with the fitting onto the fitting flange, making sure the holes align.
2. Remove the red rotor protection cap and insert the sensor into the fitting, making sure not to bump the rotor assembly. Make sure the arrow on the side of the sensor is pointing in the direction of flow.

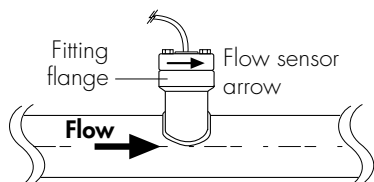

3. Slip two washers onto each bolt and insert the bolt/washer onto each of the four fitting flange holes.
4. Snug all four flange bolts in a criss-cross pattern. Using a torque wrench (when possible), torque the flange nuts in a criss-cross pattern to 52 foot-pounds.

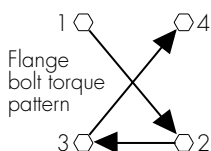

**6. Sensor Wiring**

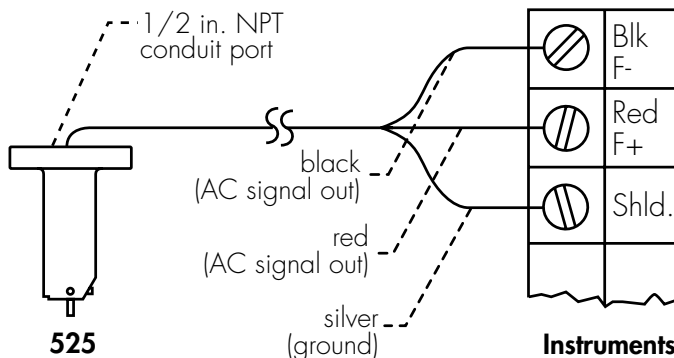

- Use 2-conductor shielded cable for cable splices to 60 m (200 ft)
- Maintain cable shield through splice.
- Shield the unjacketed silver (ground) wire using electrical tape to prevent potential noise interference and/or shorting hazards.
- +GF+ SIGNET Intelek-Pro, use 525 input card setting.

## 7. Sensor Removal Procedure

1. Depressurize and drain pipe.
2. Remove the four sensor flange bolts and lockwashers. Pull upward on the sensor flange with an alternating twisting motion.



### WARNING!

Do not remove from pressurized lines. Wear safety goggles and faceshield during installation/service.

## 8. Maintenance

The 525 sensor requires little or no maintenance of any kind, with the exception of an occasional sensor/paddlewheel cleaning.

## 9. Accessories

Refer to section 3 for a list of available Metalex sensors and fittings.

Part no.	Description	Code
P52590-1	Instruction manual	198 869 910
P52648	Fitting cap kit, cap and gasket	198 820 047
P52504-1	Rotor pin, 316 SS (optional)	198 801 500
P52504-2	Rotor pin, Tungsten Carbide (standard)	198 820 023
P52509-1	Rotor kit, 316 SS pin	198 801 501
P52509-2	Rotor kit, Tungsten pin	198 820 048

### P52509-1/P52509-2 Rotor kit

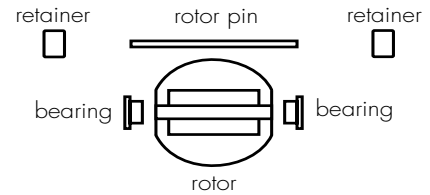

## 10. Rotor Replacement Procedure

1. With a small pair of needle-nose pliers, firmly grip the center of the rotor pin (axle) and with a twisting motion, bend the rotor pin into an "S" shape. This should pull the ends of the pin out of the retainers and free the rotor assembly.

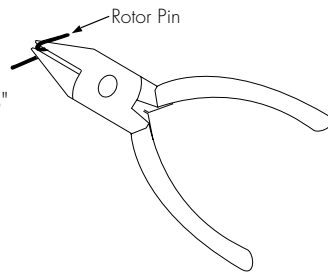

2. Remove retainer from each side by gently tapping it inwards using a punch. Install a new retainer with its rotor pin clearance hole inward. Only install one retainer at this time.

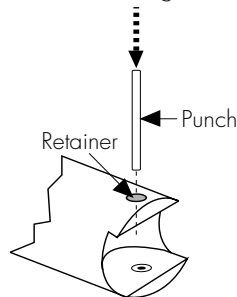

3. Insert the new rotor assembly and bearings into the rotor housing of the sensor and place the new rotor pin (axle) through the open end of the rotor housing, through the rotor and bearings, and into the previously installed retainer.

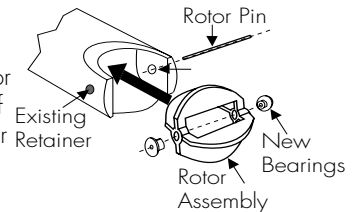

4. Tap the second retainer (rotor pin clearance hole inwards) into the hole while lining up the rotor pin with the center of the retainer hole. This completes the rotor replacement procedure.

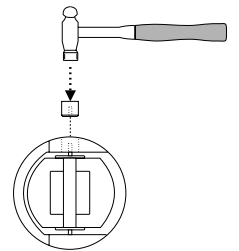

## 11. K-Factors

The K-Factor is the number of pulses the sensor will generate for each engineering unit of fluid which passes. They are listed in U.S. gallons and in liters. For example, in a 1 inch SCH 40S stainless steel pipe, the sensor generates 266.17 pulses per gallon of fluid passing the rotor. K-Factors are listed for SCH 40S stainless steel pipes up to 12 inch.

### Conversion Formulas

1 U.S. gallon = 0.003785 cubic meters  
 0.000003069 Acre feet  
 8.3454 pounds of water

SCH 40S STAINLESS STEEL PIPE PER ANSI B36.19				
	K-FACTOR	K-FACTOR	A-FACTOR	A-FACTOR
PIPE SIZE	PULSES/ U.S. GAL	PULSES/ LITER	U.S. GPM/HZ	LPM/HZ
1/2 IN.	873.03	230.66	0.0687	0.2601
3/4 IN.	515.41	136.17	0.1164	0.4406
1 IN.	266.17	70.322	0.2254	0.8532
1 1/4 IN.	148.84	39.324	0.4031	1.5258
1 1/2 IN.	107.98	28.528	0.5557	2.1032
2 IN.	64.808	17.122	0.9258	3.5042
2 1/2 IN.	44.685	11.806	1.3427	5.0822
3 IN.	28.579	7.5506	2.0994	7.9464
4 IN.	16.302	4.3070	3.6805	13.931
5 IN.	10.237	2.7046	5.8611	22.184
6 IN.	7.0057	1.8509	8.5645	32.416
8 IN.	3.9641	1.0473	15.136	57.289
10 IN.	2.4690	0.6523	24.301	91.981
12 IN.	1.6894	0.4463	35.516	134.43

## 12. Specifications

### General Data

Flow velocity range: 0.5 to 6 m/s (1.6 to 20 ft/s)  
Frequency output: 9 to 14 Hz per ft/s (depending on pipe size)  
Linearity:  $\pm 1\%$  of full range  
Repeatability:  $\pm 0.5\%$  of full range  
Pipe size range: 13 to 305 mm (0.5 to 12 in.)  
Cable length: 7.6 m (25 ft), can splice to 60 m (200 ft.)  
with no significant degradation of signal strength  
Cable type: 150 °C 22 AWG, 2-conductor w/shield

### Wetted Materials

Sensor body: ACI type CF-8M (316 cast stainless steel) per ASTM A351  
Rotor material: CD4MCu stainless steel  
Rotor pin: Tungsten Carbide GRP 1 (standard);  
316 stainless steel (optional)  
Retainers (2): 316 stainless steel  
Rotor bearings (2): Fluoroloy B®

### Electrical Data

Voltage output: Approximate sine wave, 0.005 to 0.008 V<sub>p-p</sub> per Hertz  
Coil resistance: 11.6 k $\Omega$  @ 25 °C  
Coil inductance: 3.5 Henrys @ 25 °C

### Quality Standards

- CE, FM
- Manufactured under ISO 9001

### Ambient Conditions

Maximum Pressure/Temperature Limitations:

+GF+ SIGNET 525 Metalex Sensor with:

- +GF+ SIGNET 526-1 Series Saddle Fitting: 21 bar @ 66 °C (300 psi @ 150 °F)

+GF+ SIGNET 525 Metalex Sensor with:

- +GF+ SIGNET 526-2 Series Tee or Mini-Tap Fitting: 103 bar @ 149 °C (1500 psi @ 300 °F)

## +GF+ SIGNET

### Sales Offices:

USA George Fischer, Inc., 2882 Dow Avenue, Tustin, CA 92780/USA, Tel. (714) 731-8800, Fax (714) 731-6201  
Switzerland Georg Fischer Rohrleitungssysteme AG, P.O. Box 671, CH-8201 Schaffhausen/Switzerland, Tel. 052/631 1111, Fax 052/631 2830  
Singapore George Fischer Pte. Ltd., 15 Kaki Bukit Road 2, KB Warehouse Complex, Singapore 1441, Tel. 65/747 0611, Fax 65/747 0577  
Japan Kubota George Fischer, 2-47 Shikitsuhigashi, 1-Chome, Naniwa-Ku, Osaka, 556-91 Japan, Tel. 816/648 2545, Fax 816/648 2565  
China Georg Fischer Ltd., Rm 1503, Business Residence Bldg. of Asia Plaza, 2-3 Bldg. No. 5th Qu Anzhenxili, Chaoyang Qu, Beijing 100029, P.R. China, Tel. 86/10 6443 0577, Fax 86/10 6443 0578  
Australia George Fischer Pty. Ltd., Suite 3, 41 Stamford Road, Oakleigh, Victoria 3166, Australia, Tel. 61/3 9568 0966, Fax 61/3 9568 0988

Signet Scientific Company, 3401 Aerojet Avenue, El Monte, CA 91731-2882 U.S.A., Tel. (626) 571-2770, Fax (626) 573-2057

