

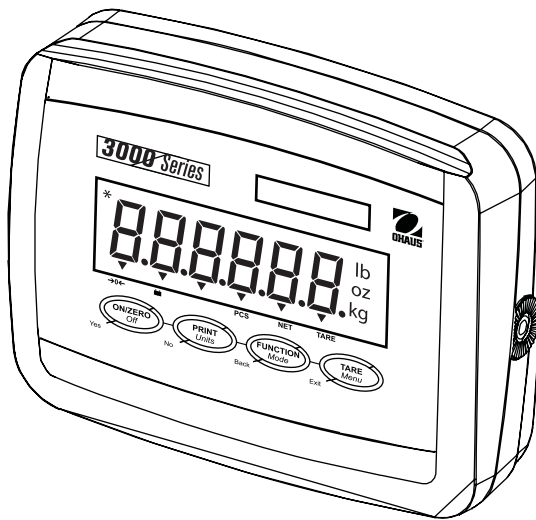

# 3000 Series Indicators

## Instruction Manual



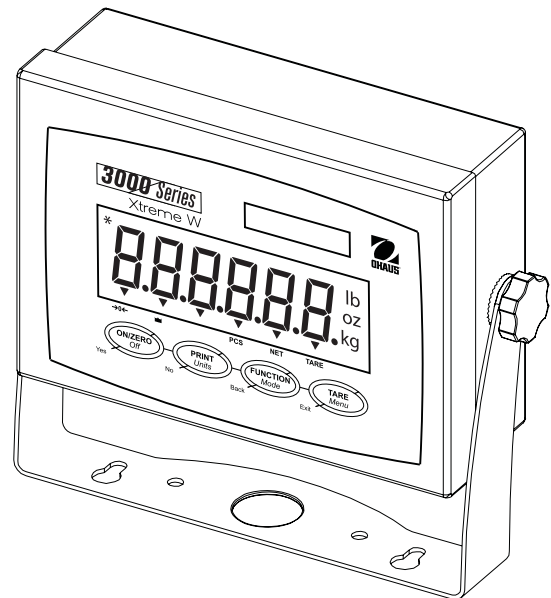

**T31P Indicator**



**T31XW Indicator**



Compliance to the following standards is indicated by the corresponding marking on the product.

Marking	Standard
	This product conforms to the EMC Directive 89/336/EEC, the Low Voltage Directive 73/23/EEC and the Non-automatic Weighing Instruments Directive 90/384/EEC. The complete Declaration of Conformity is available from Ohaus Corporation.
	AS/NZS4251.1, AS/NZS4252.1

**Important Notice for verified weighing instruments**



Weighing Instruments verified at the place of manufacture bear one of the preceding marks on the packing label and the green 'M' (metrology) sticker on the descriptive plate. They may be put into service immediately.



Weighing Instruments to be verified in two stages have no green 'M' (metrology) on the descriptive plate and bear one of the preceding identification mark on the packing label. The second stage of the initial verification must be carried out by the approved service organization of the authorized representative within the EC or by the national weights & measures (W+M) authorities.

The first stage of the initial verification has been carried out at the manufacturer's work. It comprises all tests according to the adopted European standard EN 45501:1992, paragraph 8.2.2.

If national regulations limit the validity period of the verification, the user of the weighing instrument must strictly observe the re-verification period and inform the respective W+M authorities.

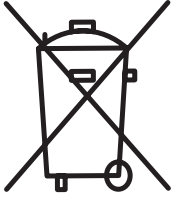

### **Disposal**

In conformance with the European Directive 2002/96/EC on Waste Electrical and Electronic Equipment (WEEE) this device may not be disposed of in domestic waste. This also applies to countries outside the EU, per their specific requirements.

Please dispose of this product in accordance with local regulations at the collecting point specified for electrical and electronic equipment.

If you have any questions, please contact the responsible authority or the distributor from which you purchased this device.

Should this device be passed on to other parties (for private or professional use), the content of this regulation must also be related.

Thank you for your contribution to environmental protection.

### **FCC Note**

This equipment has been tested and found to comply with the limits for a Class A digital device, pursuant to Part 15 of the FCC Rules. These limits are designed to provide reasonable protection against harmful interference when the equipment is operated in a commercial environment. This equipment generates, uses, and can radiate radio frequency energy and, if not installed and used in accordance with the instruction manual, may cause harmful interference to radio communications. Operation of this equipment in a residential area is likely to cause harmful interference in which case the user will be required to correct the interference at his own expense.

### **Industry Canada Note**

This Class A digital apparatus complies with the Canadian ICES-003.  
Cet appareil numérique de la classe A est conforme à la Norme NMB-003 du Canada.

### **ISO 9001 Registration**

In 1994, Ohaus Corporation, USA, was awarded a certificate of registration to ISO 9001 by Bureau Veritus Quality International (BVQI), confirming that the Ohaus quality management system is compliant with the ISO 9001 standard's requirements. On May 15, 2003, Ohaus Corporation, USA, was re-registered to the ISO 9001:2000 standard.

## TABLE OF CONTENTS

1. INTRODUCTION.....	EN-4
1.1 Safety Precautions .....	EN-4
1.2 Overview of Parts and Controls .....	EN-5
1.3 Control Functions.....	EN-9
2. INSTALLATION .....	EN-10
2.1 Unpacking .....	EN-10
2.2 External Connections.....	EN-10
2.2.1 RS232 Interface Cable to T31P.....	EN-10
2.2.2 AC Power to T31P .....	EN-10
2.2.3 AC Power to T31XW.....	EN-10
2.2.4 Battery power .....	EN-11
2.2.5 Mounting Bracket to T31XW.....	EN-11
2.3 Internal Connections.....	EN-11
2.3.1 Opening the Housing.....	EN-11
2.3.2 Scale Base to T31P or T31XW .....	EN-12
2.3.3 RS232 Interface Cable to T31XW.....	EN-12
2.4 T31P Rear Cover Orientation .....	EN-13
2.5 Direct Wall Mounting (T31P only) .....	EN-13
2.6 Mounting Bracket (T31XW only).....	EN-13
3. SETTINGS.....	EN-14
3.1 Menu Structure .....	EN-14
3.2 Menu Navigation .....	EN-15
3.3 Calibration Menu .....	EN-15
3.3.1 Span Calibration.....	EN-16
3.3.2 Linearity Calibration .....	EN-16
3.3.3 Geographical Adjustment Factor .....	EN-17
3.3.4 End Calibration.....	EN-17
3.4 Setup Menu.....	EN-19
3.4.1 Reset.....	EN-19
3.4.2 Legal for trade .....	EN-19
3.4.3 Calibration Unit.....	EN-19
3.4.4 Capacity .....	EN-19
3.4.5 Graduation.....	EN-21
3.4.6 Power On Unit .....	EN-21
3.4.7 Zero Range .....	EN-21
3.4.8 End Setup .....	EN-21

### TABLE OF CONTENTS (Cont.)

3.5	Readout Menu .....	EN-21
3.5.1	Reset .....	EN-21
3.5.2	Filter .....	EN-22
3.5.3	Auto-Zero Tracking .....	EN-22
3.5.4	Backlight .....	EN-22
3.5.5	Auto Off Timer .....	EN-22
3.5.6	End Readout .....	EN-22
3.6	Mode Menu .....	EN-23
3.6.1	Reset .....	EN-23
3.6.2	Parts Counting Mode .....	EN-23
3.6.3	End Mode .....	EN-23
3.7	Unit Menu .....	EN-24
3.7.1	Reset .....	EN-24
3.7.2	Kilogram Unit .....	EN-24
3.7.3	Pound Unit .....	EN-24
3.7.4	Gram Unit .....	EN-24
3.7.5	Ounce Unit .....	EN-24
3.7.6	Pound Ounce Unit .....	EN-24
3.7.7	End Unit .....	EN-24
3.8	Print Menu .....	EN-25
3.8.1	Reset .....	EN-25
3.8.2	Baud .....	EN-25
3.8.3	Parity .....	EN-25
3.8.4	Stop Bit .....	EN-25
3.8.5	Handshake .....	EN-26
3.8.6	Print Stable Data Only .....	EN-26
3.8.7	Auto Print .....	EN-26
3.8.8	Content .....	EN-26
3.8.9	End Print .....	EN-26
3.9	Menu Lock Menu .....	EN-27
3.9.1	Reset .....	EN-27
3.9.2	Lock Calibration .....	EN-27
3.9.3	Lock Setup .....	EN-27
3.9.4	Lock Readout .....	EN-27
3.9.5	Lock Mode .....	EN-27
3.9.6	Lock Unit .....	EN-27
3.9.7	Lock Print .....	EN-28
3.9.8	End Lock .....	EN-28

**TABLE OF CONTENTS (Cont.)**

3.10 Security Switch .....	EN-28
4. OPERATION .....	EN-28
4.1 Turning Indicator On/Off .....	EN-28
4.2 Zero Operation .....	EN-28
4.3 Manual Tare .....	EN-28
4.4 Changing Units of Measure .....	EN-29
4.5 Printing Data .....	EN-29
4.6 Application Modes .....	EN-29
4.6.1 Weighing .....	EN-29
4.6.2 Parts Counting .....	EN-29
5. SERIAL COMMUNICATION .....	EN-31
5.1 Interface Commands .....	EN-31
5.2 Output Format .....	EN-32
6. LEGAL FOR TRADE .....	EN-33
6.1 Settings .....	EN-33
6.2 Verification .....	EN-33
6.3 Sealing .....	EN-33
7. MAINTENANCE .....	EN-34
7.1 Model T31P Cleaning .....	EN-34
7.2 Model T31XW Cleaning .....	EN-34
7.3 Troubleshooting .....	EN-34
7.4 Service Information .....	EN-35
8. TECHNICAL DATA .....	EN-36
8.1 Specifications .....	EN-36
8.2 Accessories and Options .....	EN-37
8.3 Drawings and Dimensions .....	EN-38

## 1. INTRODUCTION

This manual contains installation, operation and maintenance instructions for the T31P and T31XW Indicators. Please read this manual completely before installation and operation.

### 1.1 Safety Precautions



For safe and dependable operation of this equipment, please comply with the following safety precautions:

- Verify that the input voltage range printed on the data label matches the local AC power to be used.
- Make sure that the power cord does not pose a potential obstacle or tripping hazard.
- Use only approved accessories and peripherals.
- Operate the equipment only under ambient conditions specified in these instructions.
- Disconnect the equipment from the power supply before cleaning.
- Do not operate the equipment in hazardous or unstable environments.
- Do not immerse the equipment in water or other liquids.
- Service should only be performed by authorized personnel.
- The T31XW is supplied with a grounded power cable. Use only with a compatible grounded power outlet.



1.2 Overview of Parts and Controls

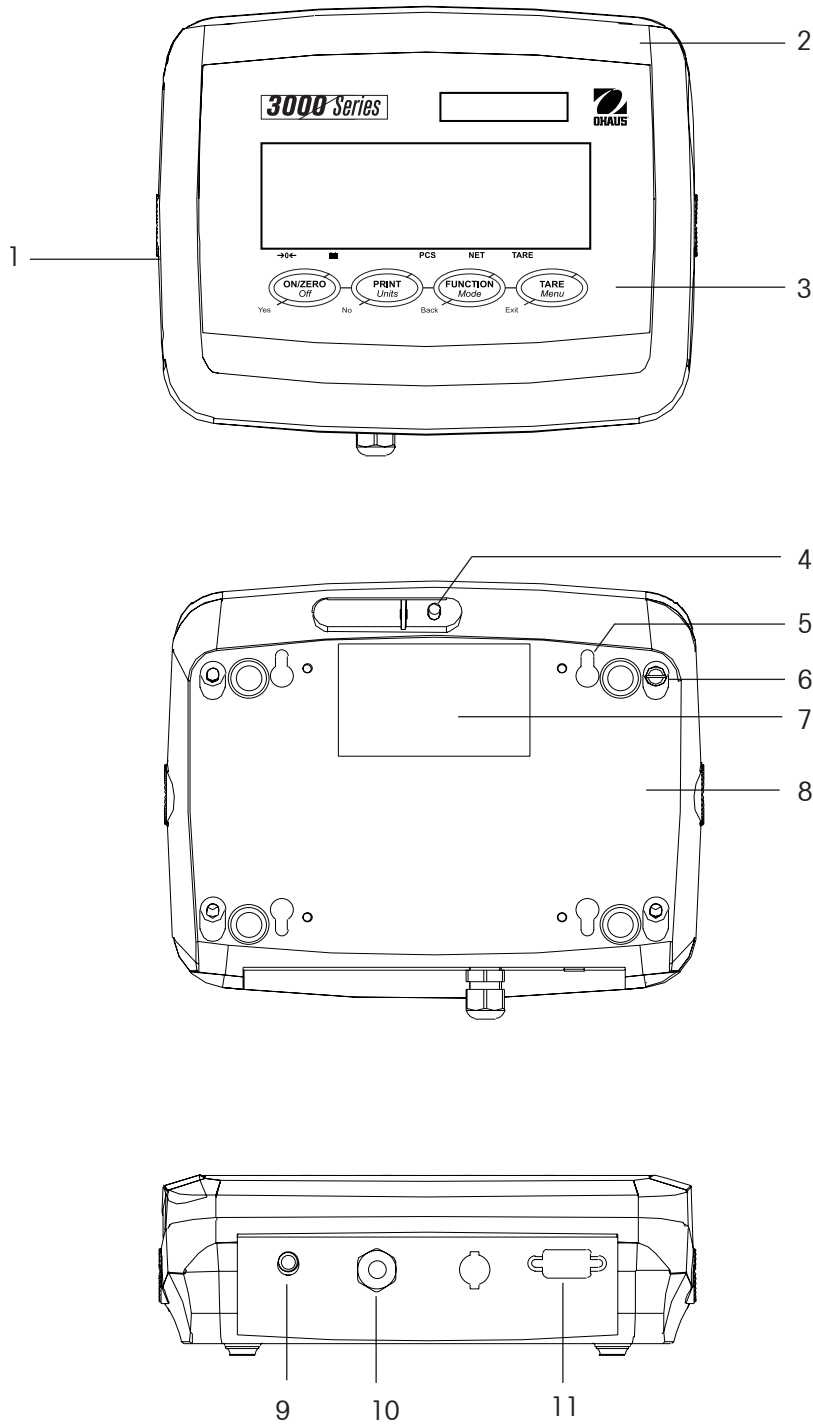

TABLE 1-1. T31P PARTS.

Item	Description
1	Data Label
2	Front Housing
3	Control Panel
4	Security Screw
5	Key Hole (4) for wall mounting
6	Screw (4)
7	Data Label
8	Rear Housing
9	Power Receptacle
10	Strain Relief for Load Cell Cable
11	RS232 Connector

Figure 1-1. T31P Indicator.

1.2 Overview of Parts and Controls (Cont.)

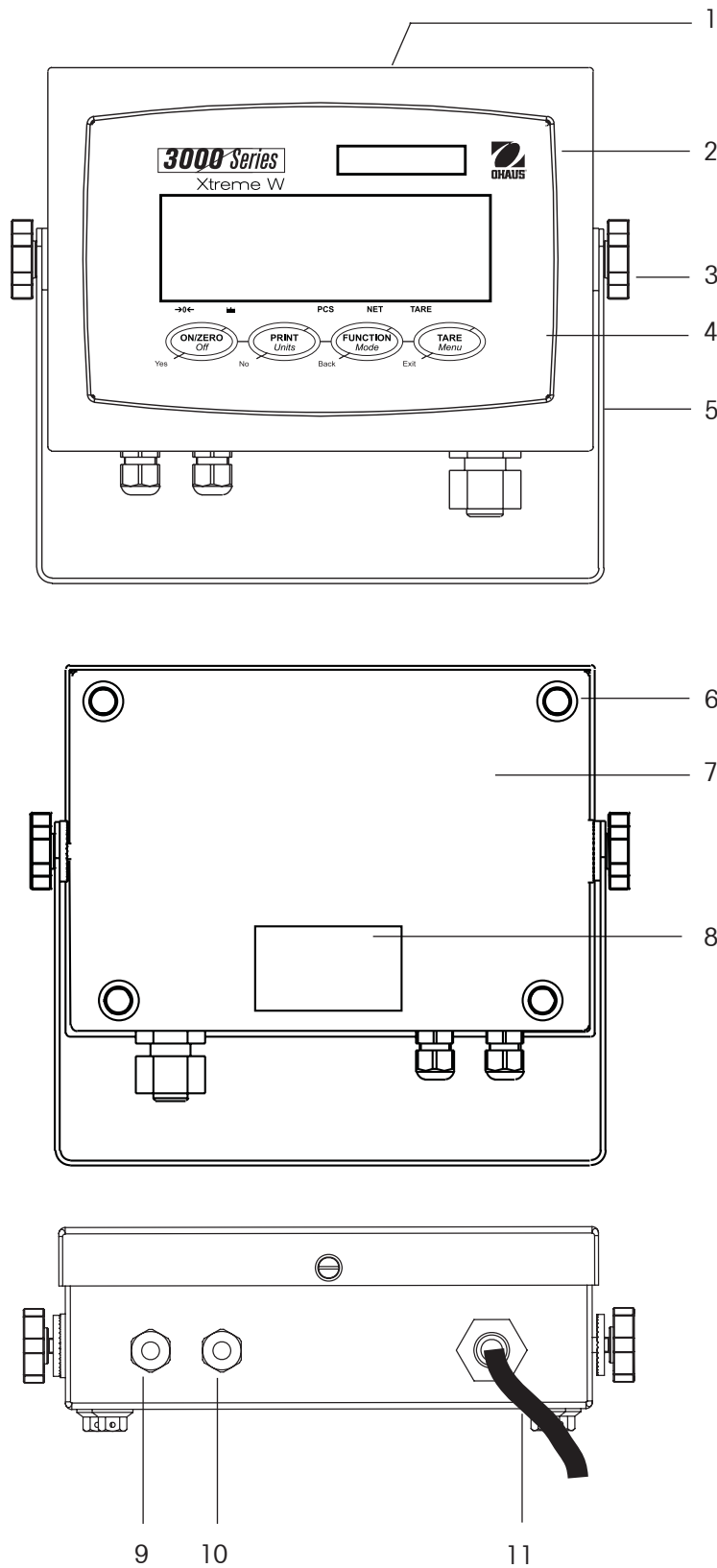

TABLE 1-2. T31XW PARTS.

Item	Description
1	Data Label
2	Front Housing
3	Adjusting Knob (2)
4	Control Panel
5	Mounting Bracket
6	Screw (4)
7	Rear Housing
8	Data Label
9	Strain Relief for RS232
10	Strain Relief for Load Cell Cable
11	Power cord

Figure 1-2. T31XW Indicator.

1.2 Overview of Parts and Controls (Cont.)

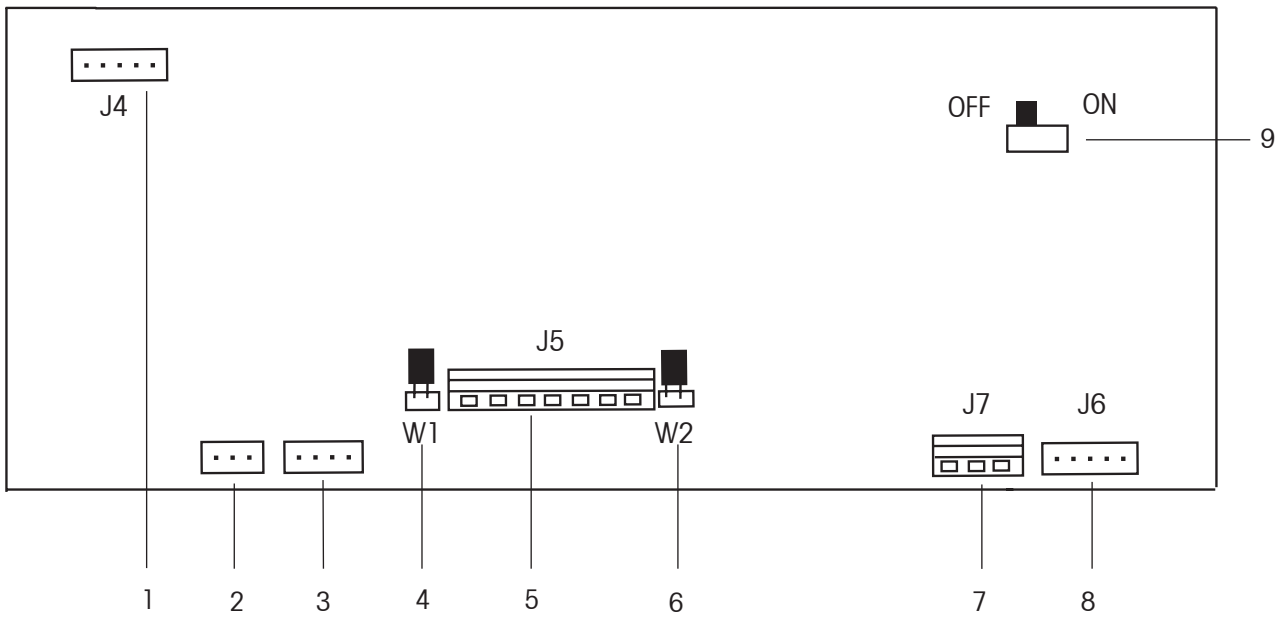
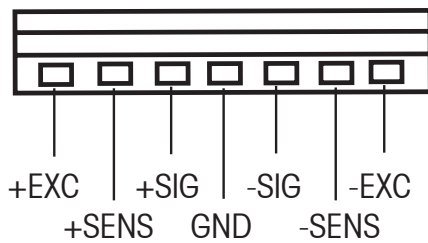

Figure 1-3. Main PC Board.

TABLE 1-3. MAIN PC BOARD.

Item	Description
1	Keypad Connector J4 T31XW Model only
2	Battery Connector
3	Line Power Input
4	Sense Jumper W1
5	Load Cell Terminal Block J5
6	Sense Jumper W2
7	RS232 Terminal Block J7 T31XW Model only
8	RS232 Connector J6 T31P Model only
9	LFT On / Off Switch

LOAD CELL WIRING



RS232 WIRING

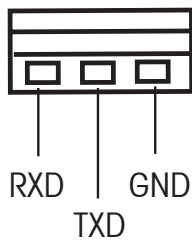

1.2 Overview of Parts and Controls (Cont.)

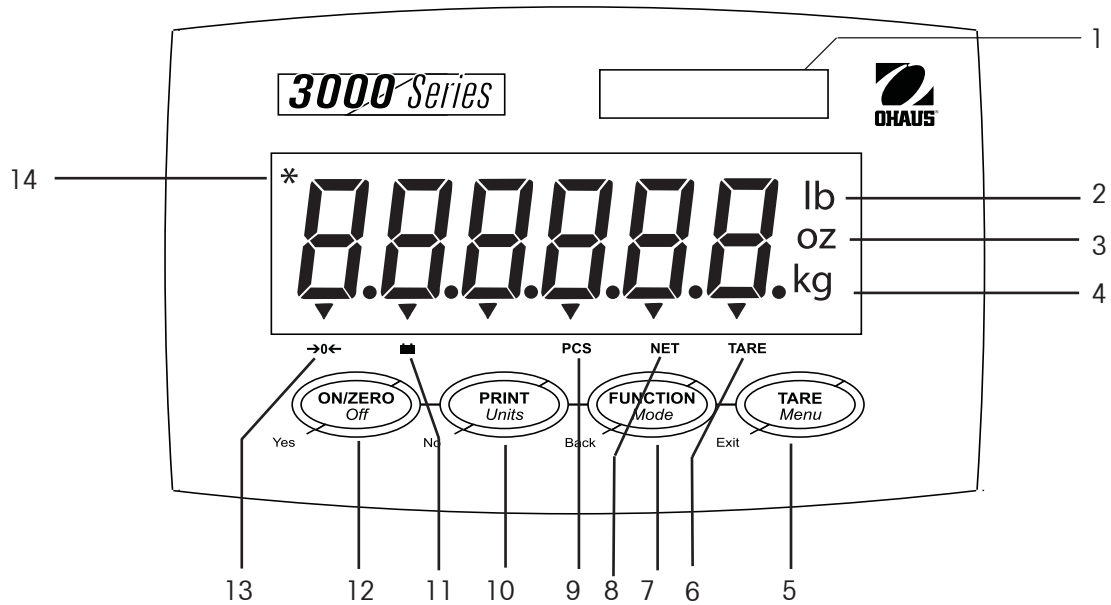





Figure 1-4. Controls and Indicators.

TABLE 1-4. CONTROL PANEL.

No.	Designation
1	Capacity Label Window
2	Pound symbol
3	Ounce symbol
4	Kilogram, gram symbols
5	TARE <i>Menu</i> button
6	TARE function symbol
7	FUNCTION <i>Mode</i> button
8	NET function symbol
9	PCS function symbol
10	PRINT <i>Units</i> button
11	Battery function symbol
12	ON/ZERO <i>Off</i> button
13	Center of Zero Indicator
14	Stable weight Indicator

1.3 Control Functions

TABLE 1-5. CONTROL FUNCTIONS.

Button	 Yes	 No	 Back	 Exit
Primary Function (Short Press)	<p><b>ON/ZERO</b> If Indicator is On, sets zero.</p>	<p><b>PRINT</b> Sends the current value to the COM port if AUTOPRINT is set to Off.</p>	<p><b>FUNCTION</b> Initiates an application mode.</p>	<p><b>TARE</b> Performs a tare operation.</p>
Secondary Function (Long Press)	<p><b>Off</b> Turns the Indicator on or off.</p>	<p><b>Units</b> Changes the weighing Unit.</p>	<p><b>Mode</b> Allows changing the application mode.  Press and hold allows scrolling through modes.</p>	<p><b>Menu</b> Enter the User menu.</p>
Menu Function (Short Press)	<p><b>Yes</b> Accepts the current setting on the display.</p>	<p><b>No</b> Advances to the next menu or menu item.  Rejects the current setting on the display and advances to the next available setting.  Increments the value.</p>	<p><b>Back</b> Moves Back to previous menu item.  Decrements the value.</p>	<p><b>Exit</b> Exits the User menu.  Aborts the calibration in progress.</p>

## 2. INSTALLATION

### 2.1 Unpacking

Unpack the following items:

- T31P or T31XW Indicator
- AC Adapter (T31P only)
- Mounting Bracket (supplied with T31XW only)
- Knobs (2) (supplied with T31XW only)
- Capacity Label Sheet
- Instruction Manual CD
- Warranty Card
- LFT sealing Kit

### 2.2 External Connections

#### 2.2.1 RS232 interface Cable to T31P

Connect the optional RS232 cable to the RS232 connector (Figure 1-1, item 13).

Pin	Connection
1	N/C
2	TXD
3	RXD
4	N/C
5	GND
6	N/C
7	N/C
8	N/C
9	N/C

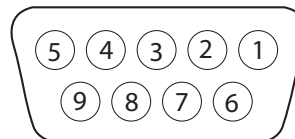

Figure 2-1. RS232 Pins.

#### 2.2.2 AC Power to T31P

Connect the AC Adapter to the power receptacle (Figure 1-1, item 8), then plug the AC Adapter into an electrical outlet.

#### 2.2.3 AC Power to T31XW

Connect the AC plug to a properly grounded electrical outlet.

### 2.2.4 Battery Power

The indicator can be operated on the internal rechargeable battery when AC power is not available. The indicator will automatically switch to battery operation if there is a power failure or the power cord is removed.



**Note:**

Before using the indicator for the first time, the internal rechargeable battery should be fully charged for up to 12 hours. The indicator can be operated during the charging process. The battery is protected against over charging and the indicator can remain connected to the AC power line.

Connect AC power to the indicator and allow it to charge. While the battery is charging, the triangle above the battery function symbol will light. When the battery is fully charged, this triangle will disappear.

The indicator can operate for up to 100 hours on a fully charged battery.

During battery operation, a flashing triangle above the battery function symbol indicates the battery is low and requires recharging. Approximately 60 minutes of operation will remain when the battery symbol starts to blink. The indicator will display Lo.BAT and automatically turn off when the battery is fully discharged.

	<b>CAUTION</b>
<b>BATTERY IS TO BE REPLACED ONLY BY AN AUTHORIZED OHAUS SERVICE DEALER.</b>	
<b>RISK OF EXPLOSION CAN OCCUR IF REPLACED WITH THE WRONG TYPE OR CONNECTED IMPROPERLY.</b>	



Dispose of the lead acid battery according to local laws and regulations.

### 2.2.5 Mounting Bracket to T31XW

Align the mounting bracket over the threaded holes in the side of the indicator and install the knobs. Adjust the indicator to the desired angle and tighten the knobs.

## 2.3 Internal Connections

Some connections require the housing to be opened.

### 2.3.1 Opening the Housing



**CAUTION: ELECTRICAL SHOCK HAZARD. REMOVE ALL POWER CONNECTIONS TO THE INDICATOR BEFORE SERVICING OR MAKING INTERNAL CONNECTIONS. THE HOUSING SHOULD ONLY BE OPENED BY AUTHORIZED AND QUALIFIED PERSONNEL, SUCH AS AN ELECTRICAL TECHNICIAN.**

**T31P**

Remove the four Phillips head screws from the rear housing.  
 Open the housing being careful not to disturb the internal connections.  
 Once all connections are made, reattach the front housing.

**T31XW**

Remove the four hex head screws from the rear housing.  
 Open the housing by carefully pulling the top of the front housing forward.  
 Once all connections are made, reattach the front housing.  
 The screws should be tightened fully to maintain a watertight seal.

**2.3.2 Scale Base to T31P or T31XW**

Pass the load cell cable through the strain relief (Figure 1-1, item 9 or Figure 1-2, item 10) and attach it to terminal block J5 (Figure 1-3, item 5).  
 Re-tighten the strain relief to ensure a watertight seal.

**Jumper Connections**

For a 4-wire load cell with no sense wires: Jumpers W2 and W3 must be shorted.  
 For a 6-wire load cell that includes sense wires, see Figure 2-2. Jumpers W2 and W3 must be opened.  
 For load cells with an extra ground shield wire: Connect the shield to the center position (GND) of J5.

Pin	Connection
J5-1	+EXCITATION
J5-2	+SENSE
J5-3	+SIGNAL
J5-4	GND
J5-5	-SIGNAL
J5-6	-SENSE
J5-7	-EXCITATION

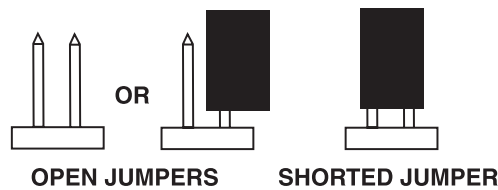

Figure 2-2. Jumper Connections.

After wiring is completed and jumpers are in place, replace the indicator housing screws. Make sure the strain relief is properly tightened.

**2.3.3 RS232 Interface Cable to T31XW**

Pass the optional RS232 cable through the strain relief (Figure 1-2, item 9) and attach it to terminal block J7 (Figure 1-3, item 7). Re-tighten the strain relief to ensure a water tight seal.

Pin	Connection
J7-1	RXD
J7-2	TXD
J7-3	GND



**2.4 T31P Rear Cover Orientation**

The T31P is delivered in the wall mount orientation with the connections exiting below the display. The rear housing may be reversed so the connections exit above the display when the T31P is placed horizontally on a bench. See Figure 2-4. To reverse the rear housing, remove the four Phillips head screws, carefully rotate the housing 180°, and reinstall the screws.

**CAUTION:** Take care not to pinch any internal cables attached inside.

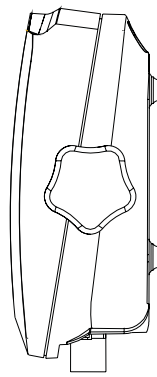

Figure 2-3. Wall Mount Configuration.

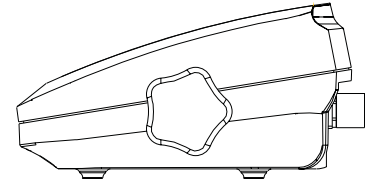

Figure 2-4. Bench Top Configuration.

**2.5 Direct Wall Mounting (T31P only)**

The T31P indicator may be mounted directly to a wall using two screws (not included). Select appropriate size screws that fit into the holes at the bottom of the indicator housing. See Figure 2-5. When mounting to a wall without a solid backing, use appropriate anchoring hardware.

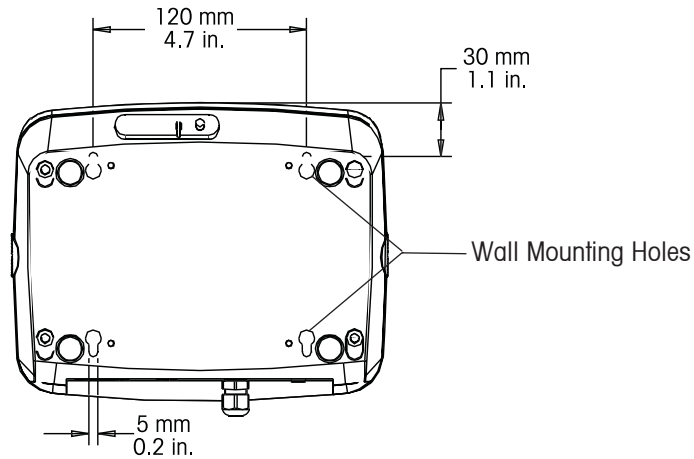

Figure 2-5. T31P Direct Wall Mounting.

**2.6 Mounting Bracket (T31XW only)**

Attach the bracket to a wall or table using fasteners (not supplied) that are appropriate for the type of mounting surface. The bracket will accommodate up to 6 mm (1/4") diameter screws. Locate the mounting holes as shown in Figure 2-6.

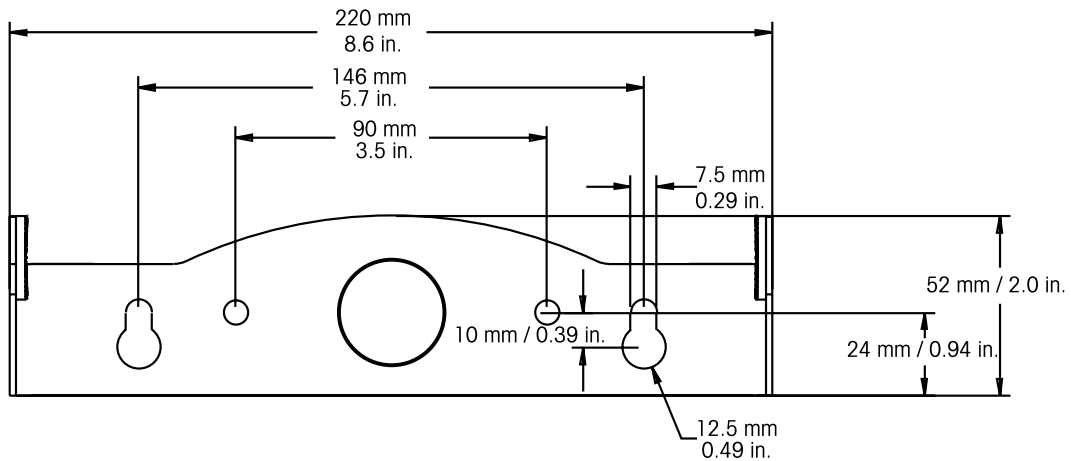
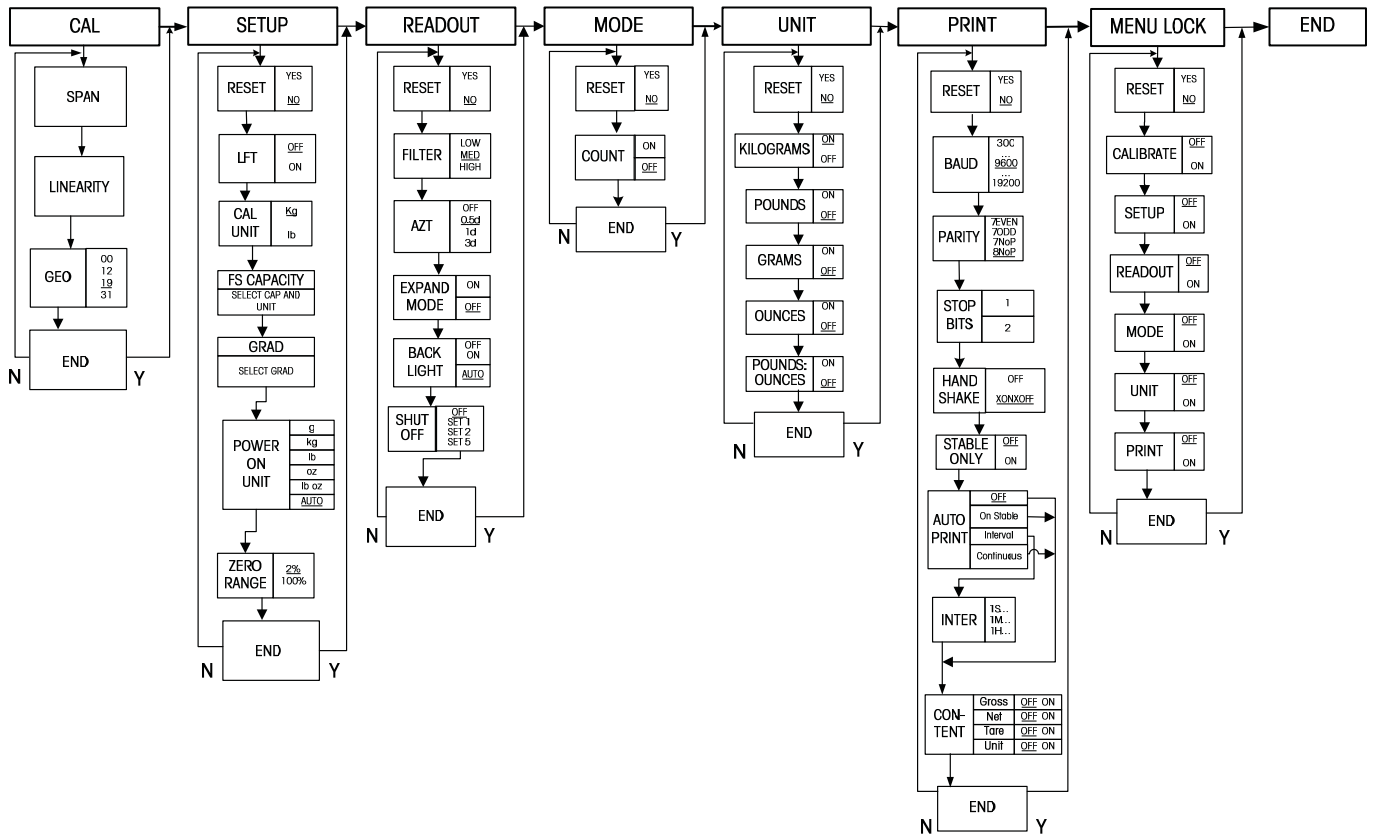

Figure 2-6. Mounting Bracket Dimensions.

**3 SETTINGS**  
**3.1 Menu Structure**

**TABLE 3-1. MENU STRUCTURE.**



## 3.2 Menu Navigation

### TO ENTER THE MENU MODE

Press and hold the Menu button until MENU appears on the display. The first upper level menu appears on the display.

Summary of button navigation functions in menu mode:

- Yes** Allows entry into the displayed menu.
  - Accepts the displayed setting and advances to the next menu item.
- No** Skips by the displayed menu.
  - Rejects the displayed setting or menu item and advances to the next available item.
- Back** Moves backwards through the upper and middle level menus.
  - Backs out of a list of selectable items to the previous middle level menu.
- Exit** Exits from menu directly to the active weighing mode.

## 3.3 Calibration Menu

Two calibration processes are available: Span Calibration and Linearity Calibration.

### NOTES:

1. Make sure that appropriate calibration masses are available before beginning calibration.
2. Make sure that the scale base is level and stable during the entire calibration process.
3. Calibration is unavailable with LFT set to On.
4. Allow the Indicator to warm up for approximately 5 minutes after stabilizing to room temperature.
5. To abort calibration, press the **Exit** button anytime during the calibration process.

Span	Perform
Linearity	Perform
Geographic	
Adjustment	Set 00... <b>Set 19</b> ... Set 31
End Calibration	Exit CALIBRATE menu

### 3.3.1 Span Calibration

Span Calibration uses two points to adjust the scale. The first point is the zero value where there is no weight on the scale. The second point is the Span value where a calibration mass is placed on the scale.

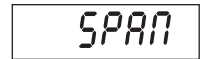

When SPAN is displayed, press the **Yes** button to access the Span Calibration menu item.

The display flashes 0.



With no weight on the scale, press the **Yes** button to establish the zero point.

The display shows --C-- while the zero point is established.

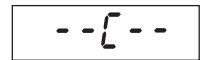

The display flashes the span calibration point. Place the specified weight on the scale and press the **Yes** button.

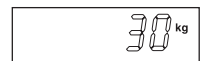

To choose a different span point, repeatedly press the **No** button to increment the selections or press the **Back** button to decrement the selections. Refer to Table 3-3 for available span points. When the desired value is displayed, place the specified weight on the scale and press the **Yes** button.

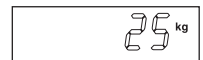

The display shows --C-- while the span point is established.

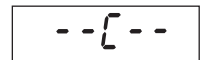

If span calibration was successful, the scale exits to the active weighing mode and displays the actual weight value.

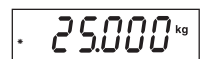

### 3.3.2 Linearity Calibration

Linearity calibration uses 3 calibration points. The first calibration point is established with no weight on the scale. The second calibration point is established at approximately half capacity. The third calibration point is established at capacity. The Linearity calibration points are fixed and cannot be altered by the user during the calibration procedure. Refer to Table 3-3 for the linearity points.



When LINEAR is displayed, press the **Yes** button to access the Linearity Calibration menu item.

The display flashes 0. With no weight on the scale, press the **Yes** button to establish the zero point.



The display shows --C-- while the zero point is established.

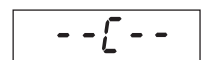

The display flashes the mid calibration point.

Place the specified weight on the scale and press the **Yes** button.



The display shows --C-- while the mid point is established.

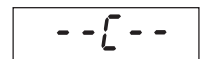

The display flashes the full calibration point.

Place the specified weight on the scale and press the **Yes** button.

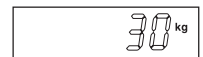

The display shows --C-- while the full point is established.

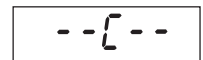

If linearity calibration was successful, the scale exits to the active weighing mode and displays the actual weight value.



### 3.3.3 Geographical Adjustment Factor

The Geographical Adjustment Factor (GEO) is used to compensate for variations in gravity.

GEO

**Note:** Changing the GEO Factor alters the calibration. The GEO value was set at the factory and should only be changed by an authorized manufacturer's representative or certified verification personnel.

Refer to table 3-2 to determine the GEO factor that corresponds to your location.

### 3.3.4 End Calibration

Advance to the next menu.

End

**TABLE 3-2. GEOGRAPHICAL ADJUSTMENT VALUES**

Geographical latitude away from the equator, (North or South) in degrees and minutes.	Elevation above sea level in meters										
	0	325	650	975	1300	1625	1950	2275	2600	2925	3250
	325	650	975	1300	1625	1950	2275	2600	2925	3250	3575
	Elevation above sea level in feet										
0	1060	2130	3200	4260	5330	6400	7460	8530	9600	10660	
1060	2130	3200	4260	5330	6400	7460	8530	9600	10660	11730	
0°00' - 5°46'	5	4	4	3	3	2	2	1	1	0	0
5°46' - 9°52'	5	5	4	4	3	3	2	2	1	1	0
9°52' - 12°44'	6	5	5	4	4	3	3	2	2	1	1
12°44' - 15°06'	6	6	5	5	4	4	3	3	2	2	1
15°06' - 17°10'	7	6	6	5	5	4	4	3	3	2	2
17°10' - 19°02'	7	7	6	6	5	5	4	4	3	3	2
19°02' - 20°45'	8	7	7	6	6	5	5	4	4	3	3
20°45' - 22°22'	8	8	7	7	6	6	5	5	4	4	3
22°22' - 23°54'	9	8	8	7	7	6	6	5	5	4	4
23°54' - 25°21'	9	9	8	8	7	7	6	6	5	5	4
25°21' - 26°45'	10	9	9	8	8	7	7	6	6	5	5
26°45' - 28°06'	10	10	9	9	8	8	7	7	6	6	5
28°06' - 29°25'	11	10	10	9	9	8	8	7	7	6	6
29°25' - 30°41'	11	11	10	10	9	9	8	8	7	7	6
30°41' - 31°56'	12	11	11	10	10	9	9	8	8	7	7
31°56' - 33°09'	12	12	11	11	10	10	9	9	8	8	7
33°09' - 34°21'	13	12	12	11	11	10	10	9	9	8	8
34°21' - 35°31'	13	13	12	12	11	11	10	10	9	9	8
35°31' - 36°41'	14	13	13	12	12	11	11	10	10	9	9
36°41' - 37°50'	14	14	13	13	12	12	11	11	10	10	9
37°50' - 38°58'	15	14	14	13	13	12	12	11	11	10	10
38°58' - 40°05'	15	15	14	14	13	13	12	12	11	11	10
40°05' - 41°12'	16	15	15	14	14	13	13	12	12	11	11
41°12' - 42°19'	16	16	15	15	14	14	13	13	12	12	11
42°19' - 43°26'	17	16	16	15	15	14	14	13	13	12	12
43°26' - 44°32'	17	17	16	16	15	15	14	14	13	13	12
44°32' - 45°38'	18	17	17	16	16	15	15	14	14	13	13
45°38' - 46°45'	18	18	17	17	16	16	15	15	14	14	13
46°45' - 47°51'	19	18	18	17	17	16	16	15	15	14	14
47°51' - 48°58'	19	19	18	18	17	17	16	16	15	15	14
48°58' - 50°06'	20	19	19	18	18	17	17	16	16	15	15
50°06' - 51°13'	20	20	19	19	18	18	17	17	16	16	15
51°13' - 52°22'	21	20	20	19	19	18	18	17	17	16	16
52°22' - 53°31'	21	21	20	20	19	19	18	18	17	17	16
53°31' - 54°41'	22	21	21	20	20	19	19	18	18	17	17
54°41' - 55°52'	22	22	21	21	20	20	19	19	18	18	17
55°52' - 57°04'	23	22	22	21	21	20	20	19	19	18	18
57°04' - 58°17'	23	23	22	22	21	21	20	20	19	19	18
58°17' - 59°32'	24	23	23	22	22	21	21	20	20	19	19
59°32' - 60°49'	24	24	23	23	22	22	21	21	20	20	19
60°49' - 62°09'	25	24	24	23	23	22	22	21	21	20	20
62°09' - 63°30'	25	25	24	24	23	23	22	22	21	21	20
63°30' - 64°55'	26	25	25	24	24	23	23	22	22	21	21
64°55' - 66°24'	26	26	25	25	24	24	23	23	22	22	21
66°24' - 67°57'	27	26	26	25	25	24	24	23	23	22	22
67°57' - 69°35'	27	27	26	26	25	25	24	24	23	23	22
69°35' - 71°21'	28	27	27	26	26	25	25	24	24	23	23
71°21' - 73°16'	28	28	27	27	26	26	25	25	24	24	23
73°16' - 75°24'	29	28	28	27	27	26	26	25	25	24	24
75°24' - 77°52'	29	29	28	28	27	27	26	26	25	25	24
77°52' - 80°56'	30	29	29	28	28	27	27	26	26	25	25
80°56' - 85°45'	30	30	29	29	28	28	27	27	26	26	25
85°45' - 90°00'	31	30	30	29	29	28	28	27	27	26	26

**3.4 Setup Menu**

SETUP

When the Indicator is used for the first time, enter this menu to set the Capacity and Graduation.

Reset	<b>No</b> , Yes
Legal for Trade	<b>Off</b> , On
Cal Unit	<b>kg</b> , lb
Capacity	<b>5</b> ...20000
Graduation	<b>0.001</b> ...20
Power On Unit	g, kg, lb, oz, lb:oz, Auto
Zero Range	<b>2%</b> , 100%
End Setup	Exit SETUP menu

**3.4.1 Reset**

Reset the Setup menu to the factory defaults.

- No = not reset.
- Yes = reset.

rESEt

NO

YES

**NOTE:** If the Legal for Trade menu item is set to ON, the Capacity, Graduation, Zero Range and Legal For Trade settings are not reset.

**3.4.2 Legal for Trade**

Set the legal for trade status.

- OFF = off
- ON = on

LFT

OFF

ON

**3.4.3 Calibration Unit**

Set the unit during calibration.

- CAL UN kg = Calibrate using kg weights
- CAL UN lb = Calibrate using pound weights

CALUN

**3.4.4 Capacity**

Set the scale capacity from 5 to 20000. Refer to the Setup Table 3.3 for available settings.

CAP

TABLE 3-3. SETUP AND CALIBRATION VALUES

Capacity	Graduation size with LFT OFF	Graduation size with LFT ON	Span calibration points	Linearity calibration points
5	0.001, 0.002, 0.005	0.001, 0.002, 0.005	5	2, 5
10	0.001, 0.002, 0.005, 0.01	0.002, 0.005, 0.01	5, 10	5, 10
15	0.002, 0.005, 0.01	0.005, 0.01	5, 10, 15	5, 15
20	0.002, 0.005, 0.01, 0.02	0.005, 0.01, 0.02	5, 10, 15, 20	10, 20
25	0.005, 0.01, 0.02	0.005, 0.01, 0.02	5, 10, 15, 20, 25	10, 25
30	0.005, 0.01, 0.02	0.005, 0.01, 0.02	5, 10, 15, 20, 25, 30	15, 30
40	0.005, 0.01, 0.02	0.01, 0.02	5, 10, 15, 20, 25, 30, 40	20, 40
50	0.005, 0.01, 0.02, 0.05	0.01, 0.02, 0.05	5, 10, 15, 20, 25, 30, 40, 50	25, 50
60	0.01, 0.02, 0.05	0.01, 0.02, 0.05	5, 10, 15, 20, 25, 30, 40, 50, 60	30, 60
75	0.01, 0.02, 0.05	0.02, 0.05	5, 10, 15, 20, 25, 30, 40, 50, 60, 75	30, 75
100	0.01, 0.02, 0.05, 0.1	0.02, 0.05, 0.1	5, 10, 15, 20, 25, 30, 40, 50, 60, 75, 100	50, 100
120	0.02, 0.05, 0.1	0.02, 0.05, 0.1	5, 10, 15, 20, 25, 30, 40, 50, 60, 75, 100, 120	60, 120
150	0.02, 0.05, 0.1	0.05, 0.1	5, 10, 15, 20, 25, 30, 40, 50, 60, 75, 100, 120, 150	75, 150
200	0.02, 0.05, 0.1, 0.2	0.05, 0.1, 0.2	5, 10, 15, 20, 25, 30, 40, 50, 60, 75, 100, 120, 150, 200	100, 200
250	0.05, 0.1, 0.2	0.05, 0.1, 0.2	5, 10, 15, 20, 25, 30, 40, 50, 60, 75, 100, 120, 150, 200, 250	120, 250
300	0.05, 0.1, 0.2	0.05, 0.1, 0.2	5, 10, 15, 20, 25, 30, 40, 50, 60, 75, 100, 120, 150, 200, 250, 300	150, 300
400	0.05, 0.1, 0.2	0.1, 0.2	5, 10, 15, 20, 25, 30, 40, 50, 60, 75, 100, 120, 150, 200, 250, 300, 400	200, 400
500	0.05, 0.1, 0.2, 0.5	0.1, 0.2, 0.5	5, 10, 15, 20, 25, 30, 40, 50, 60, 75, 100, 120, 150, 200, 250, 300, 400, 500	250, 500
600	0.1, 0.2, 0.5	0.1, 0.2, 0.5	5, 10, 15, 20, 25, 30, 40, 50, 60, 75, 100, 120, 150, 200, 250, 300, 400, 500, 600	300, 600
750	0.1, 0.2, 0.5	0.2, 0.5	5, 10, 15, 20, 25, 30, 40, 50, 60, 75, 100, 120, 150, 200, 250, 300, 400, 500, 600, 750	300, 750
1000	0.1, 0.2, 0.5, 1	0.2, 0.5, 1	5, 10, 15, 20, 25, 30, 40, 50, 60, 75, 100, 120, 150, 200, 250, 300, 400, 500, 600, 750, 1000	500, 1000
1200	0.2, 0.5, 1	0.2, 0.5, 1	5, 10, 15, 20, 25, 30, 40, 50, 60, 75, 100, 120, 150, 200, 250, 300, 400, 500, 600, 750, 1000, 1200	600, 1200
1500	0.2, 0.5, 1	0.5, 1	5, 10, 15, 20, 25, 30, 40, 50, 60, 75, 100, 120, 150, 200, 250, 300, 400, 500, 600, 750, 1000, 1200, 1500	750, 1500
2000	0.2, 0.5, 1, 2	0.5, 1, 2	5, 10, 15, 20, 25, 30, 40, 50, 60, 75, 100, 120, 150, 200, 250, 300, 400, 500, 600, 750, 1000, 1200, 1500, 2000	1000, 2000
2500	0.5, 1, 2	0.5, 1, 2	5, 10, 15, 20, 25, 30, 40, 50, 60, 75, 100, 120, 150, 200, 250, 300, 400, 500, 600, 750, 1000, 1200, 1500, 2000, 2500	1200, 2500
3000	0.5, 1, 2	0.5, 1, 2	5, 10, 15, 20, 25, 30, 40, 50, 60, 75, 100, 120, 150, 200, 250, 300, 400, 500, 600, 750, 1000, 1200, 1500, 2000, 2500, 3000	1500, 3000
5000	0.5, 1, 2, 5	1, 2, 5	5, 10, 15, 20, 25, 30, 40, 50, 60, 75, 100, 120, 150, 200, 250, 300, 400, 500, 600, 750, 1000, 1200, 1500, 2000, 2500, 3000, 5000	2500, 5000
6000	0.5, 1, 2, 5	1, 2, 5	5, 10, 15, 20, 25, 30, 40, 50, 60, 75, 100, 120, 150, 200, 250, 300, 400, 500, 600, 750, 1000, 1200, 1500, 2000, 2500, 3000, 5000, 6000	2500, 5000
7500	1, 2, 5	2, 5	5, 10, 15, 20, 25, 30, 40, 50, 60, 75, 100, 120, 150, 200, 250, 300, 400, 500, 600, 750, 1000, 1200, 1500, 2000, 2500, 3000, 5000, 6000, 7500	3000, 7500
10000	1, 2, 5, 10	2, 5, 10	5, 10, 15, 20, 25, 30, 40, 50, 60, 75, 100, 120, 150, 200, 250, 300, 400, 500, 600, 750, 1000, 1200, 1500, 2000, 2500, 3000, 5000, 6000, 7500, 10000	5000, 10000
20000	2, 5, 10, 20	5, 10, 20	5, 10, 15, 20, 25, 30, 40, 50, 60, 75, 100, 120, 150, 200, 250, 300, 400, 500, 600, 750, 1000, 1200, 1500, 2000, 2500, 3000, 5000, 6000, 7500, 10000, 20000	10000, 20000



**3.4.5 Graduation**

Set the scale readability.

0.001, 0.002, 0.005, 0.01, 0.02, 0.05, 0.1, 0.2, 0.5, 1, 2, 5, 10, 20.

**NOTE:** Not all settings are available for each capacity. Refer to the Setup Table 3.3 for available settings.

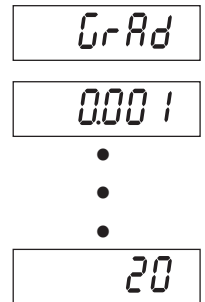

**3.4.6 Power On Unit**

Set the unit that will be active at power on.

oz, lb, g, kg, lb:oz or

Auto (last unit in use when power was turned off.)

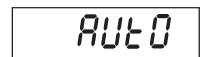

**3.4.7 Zero Range**

Set the percentage of scale capacity that may be zeroed.

2% = zero up to 2 percent of capacity

100% = zero up to full capacity



**3.4.8 End Setup**

Advance to the next menu.

**3.5 Readout Menu**

Enter this menu to customize display functionality.

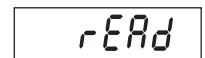

Reset:	<b>No</b> , Yes
Filter Level	Lo, <b>Med</b> , Hi
Auto Zero Tracking	Off, <b>0.5d</b> , 1d, 3d
Backlight	Off, On, <b>Auto</b>
Auto Shut Off	<b>Off</b>
End Readout	Exit READOUT menu

**3.5.1 Reset**

Set the Readout menu to factory default settings.

No = not reset

Yes = reset

If the Legal for Trade menu item is set to ON, the Stable Range, Averaging Level, Auto Zero Tracking and Auto Off settings are not reset.



**3.5.2 Filter**

Set the amount of signal filtering.

- LO = less stability, faster stabilization time ( $\leq 1$  sec.)
- MEd = normal stability, stabilization time ( $\leq 2$  sec.)
- HI = greater stability, slower stabilization time ( $\leq 3$  sec.)

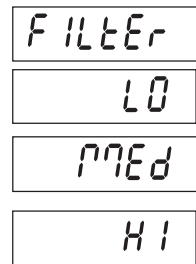

**3.5.3 Auto-Zero Tracking**

Set the automatic zero tracking functionality.

- OFF = disabled.
- 0.5 d = the display will maintain zero until a drift of 0.5 divisions per second has been exceeded.
- 1 d = the display will maintain zero until a drift of 1 division per second has been exceeded.
- 3 d = the display will maintain zero until a drift of 3 divisions per second has been exceeded.

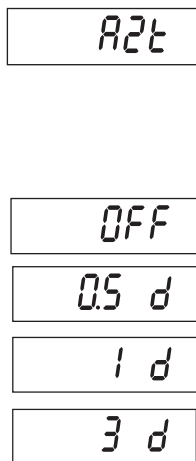

**NOTE:** When the LFT menu item is set to ON, the selections are limited to 0.5d and 3d. The setting is locked when the hardware lock switch is set to the ON position.

**3.5.4 Backlight**

Set the display backlight functionality.

- OFF = always off.
- ON = always on.
- AUTO = turns on when a button is pressed or the displayed weight changes. turns off after 5 seconds of no activity.



**3.5.5 Auto Off Timer**

Set the automatic shut off functionality.

- OFF = disabled
- SEt 1 = powers off after 1 minute of no activity.
- SEt 2 = powers off after 2 minutes of no activity.
- SEt 5 = powers off after 5 minutes of no activity.

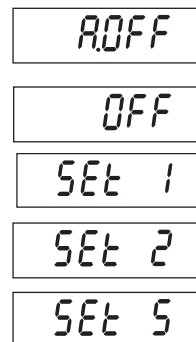

**3.5.6 End Readout**

Advance to the next menu.

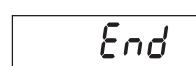

### 3.6 Mode Menu

Enter this menu to activate the desired application modes.

MODE

Reset:	<b>No</b> , Yes
Count:	<b>Off</b> , On
End Mode	Exit MODE menu

#### 3.6.1 Reset

Set the Mode menu to the factory defaults.

No = not reset.

Yes = reset.

**NOTE:** If the Legal for trade menu item is set ON, the settings are not reset.

RESET

NO

YES

#### 3.6.2 Parts Counting Mode

Set the status.

OFF = Disabled

ON = Enabled

COUNT

OFF

ON

#### 3.6.3 End Mode

Advance to the next menu.

End

### 3.7 Unit Menu

Enter this menu to activate the desired units.  
 Default settings are bold.



Reset:	<b>No</b> , Yes
Kilograms:	Off, <b>On</b>
Pounds:	<b>Off</b> , On
Grams:	<b>Off</b> , On
Ounces:	<b>Off</b> , On
Pounds:Ounces	<b>Off</b> , On
End Unit	Exit UNIT menu

#### 3.7.1 Reset

Set the Unit menu to the factory defaults.

Settings:

- NO = not reset.
- YES = reset

If the Legal for Trade menu item is set ON, the settings are not reset.

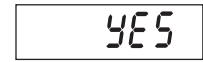
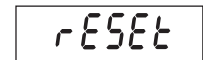

#### 3.7.2 Kilogram Unit

Set the status.

- OFF = Disabled
- ON = Enabled



#### 3.7.3 Pound Unit

Set the status.

- OFF = Disabled
- ON = Enabled



#### 3.7.4 Gram Unit

Set the status.

- OFF = Disabled
- ON = Enabled



#### 3.7.5 Ounce Unit

Set the status.

- OFF = Disabled
- ON = Enabled



#### 3.7.6 Pound Ounce Unit

Set the status.

- OFF = Disabled
- ON = Enabled



**3.7.7 End Unit**

Advance to the next menu.

End

**3.8 Print Menu**

Print

Enter this menu to define printing parameters. Default settings are bold.

**3.8.1 Reset**

Set the Print menu to factory defaults.

NO = not reset.

YES = reset.

rESEt

no

YES

Reset	<b>No</b> , Yes
Baud Rate:	300, 600, 1200, 2400, 4800, <b>9600</b> , 19200
Parity:	7 Even, 7 Odd, 7 None, <b>8 None</b>
Stop Bit	<b>1</b> or 2
Handshake:	Off, <b>XON/XOFF</b>
Stable Only	<b>Off</b> , On
Auto Print	<b>Off</b> , On Stable (-> Load, Load and Zero), Interval (-> 1...3600), Continuous
Exit PRINT menu	

**NOTE:** If the Legal for Trade menu item is set to ON, the following settings are not reset: Stable, Auto Print

**3.8.2 Baud**

Set the Baud rate.

- 300 = 300 bps
- 600 = 600 bps
- 1200 = 1200 bps
- 2400 = 2400 bps
- 4800 = 4800 bps
- 9600 = 9600 bps
- 19200 = 19200 bps

baud

300

600

1200

2400

4800

9600

19200

**3.8.3 Parity**

Set the data bits and parity.

- 7 EVEN = 7 data bits, even parity.
- 7 Odd = 7 data bits, odd parity.
- 7 NONE = 7 data bits, no parity.
- 8 NONE = 8 data bits, no parity.

PARity

7 EVEN

7 Odd

7 NONE

8 NONE

**3.8.4 Stop Bit**

Set the number of stop bits.

- 1 = 1 stop bit.
- 2 = 2 stop bits.

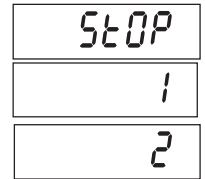

**3.8.5 Handshake**

Set the flow control method.

- NONE = no handshaking.
- ON-OFF = XON/XOFF software handshaking.



**3.8.6 Print Stable Data Only**

Set the print criteria.

- OFF = values are printed immediately.
- ON = values are only printed when the stability criteria are met.

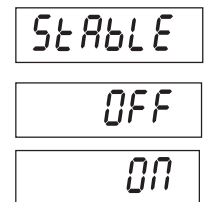

**3.8.7 Auto Print**

Set the automatic printing functionality.

- OFF = disabled.
- ON.StAb = printing occurs each time the stability criteria are met.
- INtEr = printing occurs at the defined interval.
- CONt = printing occurs continuously.

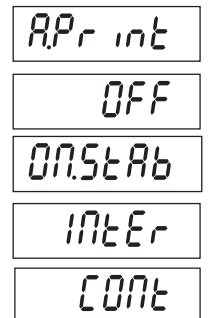

When INtEr is selected, set the Print Interval.

1 to 3600 (seconds)

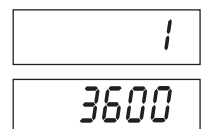

**3.8.8 Content**

Select the additional content of the printout.

- GROSS OFF = Gross weight is not printed.
- GROSS ON = Gross weight is printed.
- NET OFF = Net weight is not printed.
- NET ON = Net weight is printed.
- TARE OFF = Tare weight is not printed.
- TARE ON = Tare weight is printed.
- UNIT OFF = Unit is not printed.
- UNIT ON = Unit weight is printed.

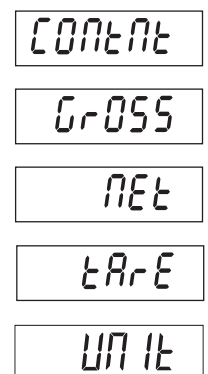

**3.8.9 End Print**

Advance to the next menu.

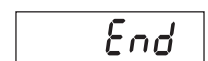

### 3.9 Menu Lock Menu

LPMENU

Enter this menu. Default settings are bold.

Reset:	<b>No</b> , Yes
Lock Calibration Menu	<b>Off</b> , On
Lock Setup Menu	<b>Off</b> , On
Lock Readout Menu	<b>Off</b> , On
Lock Mode Menu	<b>Off</b> , On
Lock Unit Menu	<b>Off</b> , On
Lock Print Menu	<b>Off</b> , On
End Lock Menu	

#### 3.9.1 Reset

Set the menu Lock menu to factory defaults.

- NO = not reset.
- YES = reset.

RESET

NO

YES

**NOTE:** Settings for LFT controlled menu items are not reset.

#### 3.9.2 Lock Calibration

Set the status.

- OFF = Calibration menu is not locked.
- ON = Calibration menu is locked and hidden.

LCAL

OFF

ON

#### 3.9.3 Lock Setup

Set the status.

- OFF = Setup menu is not locked.
- ON = Setup menu is locked and hidden.

LSETUP

OFF

ON

#### 3.9.4 Lock Readout

Set the status.

- OFF = Readout menu is not locked.
- ON = Readout menu is locked and hidden.

LREAD

OFF

ON

#### 3.9.5 Lock Mode

Set the status.

- OFF = Mode menu is not locked.
- ON = Mode menu is locked and hidden.

LPMODE

OFF

ON

#### 3.9.6 Lock Unit

Set the status.

- OFF = Unit menu is not locked.
- ON = Unit menu is locked and hidden.

LUNIT

OFF

ON

### 3.9.7 Lock Print

Set the status.

- OFF = Print menu is not locked.
- ON = Print menu is locked.



### 3.9.8 End Lock

Advance to the next menu.

### 3.10 Security Switch

A security switch is located on the Main PCB board. When the switch is set to the on position, user menu settings that were locked in the Menu Lock can not be changed.

Open the housing as explained in Section 2.3.1. Set the position of security switch to ON as shown in Figure 1-3.

## 4 OPERATION

### 4.1 Turning Indicator On/Off

To turn the Indicator on, press the and hold the **ON/ZERO Off** button for 2 seconds. The Indicator performs a display test, momentarily displays the software version, and then enters the active weighing mode.

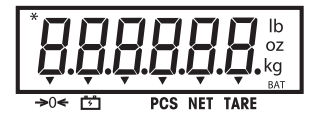

To turn the Indicator off, press and hold the **ON/ZERO Off** button until OFF is displayed.



### 4.2 Zero Operation

Zero can be set under the following conditions:

- Automatically at Power On (initial zero).
- Semi-automatically (manually) by pressing the **ON/ZERO Off** button.
- Semi-automatically by sending the Zero command (Z or alternate zero command).

Press the **ON/ZERO Off** button to zero the weight display. The scale must be stable to accept zero operation.



### 4.3 Manual Tare

When weighing an item that must be held in a container, taring stores the container weight in memory. Place the empty container on the scale (example 0.5 kg) and press the **TARE** button. The display will show the net weight.



To clear the Tare value, empty the scale and press the **TARE** button. The display will show the gross weight.





### 4.4 Changing Units of Measure

Press and hold the **PRINT Units** button until the desired measuring unit appears. Only measuring units enabled in the Unit Menu will be displayed (refer to Section 3.7).

### 4.5 Printing Data

Printing the displayed data to a printer or sending the data to a computer requires that the communication parameters in the Print Menu are set (refer to Section 3.8).

Press the **PRINT Units** button to send the displayed data to the communication port (the Auto-Print Mode in Section 3.8 function must be Off).

### 4.6 Application Modes

Only modes enabled in the mode menu will be displayed (refer to Section 3-6).

#### 4.6.1 Weighing

Place the item to be weighed on the scale. The illustration indicates a sample of 1.5 kg, Gross weight.



**Note:** To return to the Weighing mode from the Parts Counting mode, press and hold the **Mode** button until WEIGH is displayed.



#### 4.6.2 Parts Counting

Use this mode to count parts of uniform weight. The Indicator determines the quantity based on the average weight of a single part. All parts must be uniform in weight for accurate measurements.



To enter the Parts Counting mode, press and hold the **Mode** button until Count is displayed.

#### Average Piece Weight (APW)

When the **Mode** button is released, CLr.PW Pcs is displayed.



**NOTE:** If no APW has been previously stored, the CLr.PW display is skipped and the display shows PU10Pcs.

#### Clearing a Stored APW

Press the **Yes** button to clear the stored APW.

**Recalling a Stored APW**

Press the **No** button to recall the existing APW.

Press the **FUNCTION Mode** button to temporarily display the APW value.



**Establishing the Average Piece Weight (APW)**

The display shows Put10 Pcs.

**Establishing a New APW**

Press the **No** button to increment the sample size. Choices are 5, 10, 20, 50, 100 and 200.

To establish the APW, place the specified quantity of samples on the scale and press the **Yes** button to capture the weight.

**Begin Counting**

Place the parts on the scale and read the count. If a container is used, be sure to tare the empty container first.



## 5 SERIAL COMMUNICATION

The T31P and T31XW Indicators include an RS232 serial communication interface.

The setup of RS232 operating parameters are more fully explained in Section 3.8. The physical hardware connection is explained in Section 2.2.

The interface enables display data to be sent to a computer or printer. A computer can be used to control some functions of the indicator using the commands listed in Table 5-1.

### 5.1 Interface Commands

Communicate to the indicator using the command characters listed in Table 5-1.

**TABLE 5-1. SERIAL INTERFACE COMMAND TABLE.**

Command Character	Function
IP	Immediate Print of displayed weight (stable or unstable).
P	Print stable displayed weight (according to stability setting).
CP	Continuous Print.
SP	Print when stable.
xP	Interval Print x = Print Interval (1-3600 sec)
Z	Same as pressing Zero button
T	Same as pressing Tare button
xT	Download Tare value in grams (positive values only). Sending 0T clears tare (if allowed)
PU	Print current unit: g, kg, lb, oz, lb:oz
xU	Set scale to unit x: 1=g, 2=kg, 3=lb, 4=oz, 5=lb:oz
PV	Version: print name, software revision and LFT ON (if LFT is set ON).
Esc R	Global reset to reset all menu settings to the original factory defaults

#### NOTES:

- Commands sent to the Indicator must be terminated with a carriage return (CR) or carriage return-line feed (CRLF).
- Data output by the Indicator is always terminated with a carriage return-line feed (CRLF).

## 5.2 Output Format

The default serial output format is shown below.

<b>Field:</b>	<b>Polarity</b>	<b>Space</b>	<b>Weight</b>	<b>Space</b>	<b>Unit</b>	<b>Stability</b>	<b>Legend</b>	<b>CR</b>	<b>LF</b>
<b>Length:</b>	<b>1</b>	<b>1</b>	<b>7</b>	<b>1</b>	<b>5</b>	<b>1</b>	<b>3</b>	<b>1</b>	<b>1</b>

Definitions: Polarity, "-" sign if negative, blank if positive.

Weight, up to 6 numbers and 1 decimal, right justified, leading zero blanking.

Units, up to 5 characters.

Stability, "?" character is printed if not stable, blank if stable.

Legend, up to 3 characters: G = gross weight, NET = net weight, T = tare

## 6. LEGAL FOR TRADE

### 6.1 Settings

Enter the menu to verify the settings and perform a calibration as explained in Section 3. Set the LFT menu to ON. Exit the Setup menu and power off the indicator.

Open the housing as explained in Section 2.3.1.

Set the position of the security switch to ON as shown in Figure 1-3, (item 9).

Close the housing.

**NOTE:** When LFT is set to ON and the security switch is set to ON, the following menu settings cannot be changed: Span Calibration, Linearity Calibration, Calibration Unit, GEO, LFT, Capacity, Graduation, Zero Range, Stable Range, AZT, Modes, Units. To enable editing of these menu settings, return the security switch to the off position and set LFT menu item to off.

### 6.2 Verification

Before this product can be used in a trade approved application, it must be inspected in accordance with local weights and measures regulations. It is the responsibility of the purchaser to ensure that all pertinent legal requirements are met. Please contact your local weights and measures office for further details.

### 6.3 Sealing

The weights and measures official can apply a wire or paper security seal as shown below.

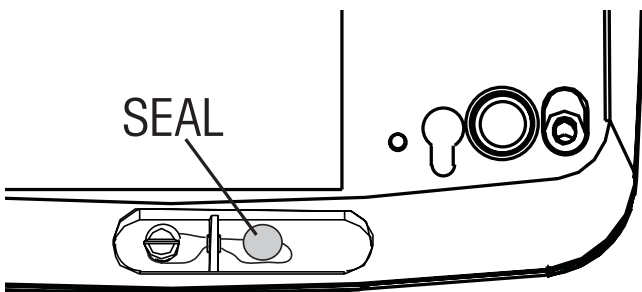

Figure 6-1. T31P Wire Seal

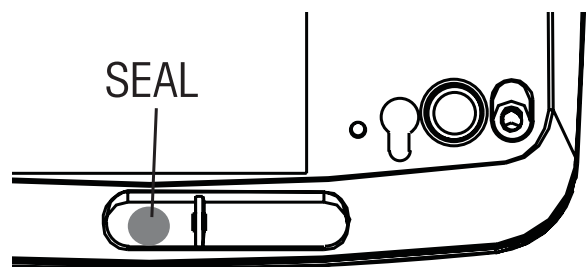

Figure 6-2. T31P Paper Seal

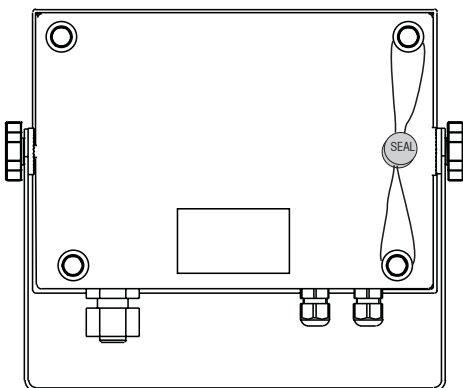

Figure 6-3. T31XW Wire Seal

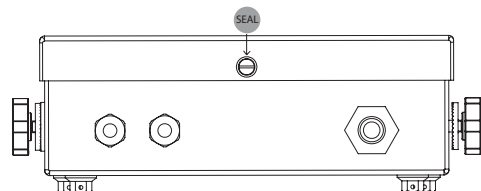

Figure 6-4. T31XW Paper Seal

## 7 MAINTENANCE

**CAUTION: DISCONNECT THE UNIT FROM THE POWER SUPPLY BEFORE CLEANING.**

### 7.1 Model T31P Cleaning

- The housing may be cleaned with a cloth dampened with a mild detergent if necessary.
- Do not use solvents, chemicals, alcohol, ammonia or abrasives to clean the housing or control panel.

### 7.2 Model T31XW Cleaning

- Use approved cleaning solutions for the stainless-steel Indicator housing and rinse with water. Dry thoroughly.
- Do not use solvents, chemicals, alcohol, ammonia or abrasives to clean the control panel.

### 7.3 Troubleshooting

**TABLE 7-1. TROUBLESHOOTING.**

SYMPTOM	PROBABLE CAUSE(S)	REMEDY
Unit will not turn on.	Power cord not plugged in or properly connected.  Power outlet not supplying electricity.  Battery power used up.  Other failure.	Check power cord connections. Make sure power cord is plugged in properly into the power outlet.  Check power source.  Reconnect AC power to charge the battery.  Service required.
Cannot zero the Scale, or will not zero when turned on.	Load on Scale exceeds allowable limits.  Load on Scale is not stable.  Load Cell damage.	Remove load on Scale.  Wait for load to become stable.  Service required.
Unable to calibrate.	Lock Calibration Menu set to On.  Lock switch is "on".  LFT menu set to On.  Incorrect value for calibration mass.	Set Lock Calibration Menu to Off. Refer to Section 3.9 Menu Lock. Set the Lock switch to Off.  Set LFT menu to Off.  Use correct calibration mass.
Cannot display weight in desired weighing unit.	Unit not set to On.	Enable unit in the Units Menu. Refer to Section 3.7 in the Unit Menu.
Cannot change menu settings.	Menu has been locked.  Lock switch set on.	Set selected menu to Off in the Lock Menu. Lock Switch on the circuit board may need to be set to the Off position.  Set the Lock switch to off.
Battery indicator is flashing.	Battery discharged.	Connect indicator to power and charge battery.
Battery fails to charge fully.	Battery is defective.	Have the battery replaced by an authorized Ohaus service dealer.
Error 7.0	Unstable weight reading when defining reference weight.	Unstable Error, check platform location.
Error 8.1	Weight reading exceeds Power On Zero limit.	Remove load from scale. Recalibrate scale.
Error 8.2	Weight reading below Power On Zero limit.	Add load to scale. Recalibrate scale.
Error 8.3	Weight reading exceeds Overload limit.	Reduce load on scale.
Error 8.4	Weight reading below Underload limit.	Add load to scale. Recalibrate scale.

TABLE 7-1. TROUBLESHOOTING (Cont.).

SYMPTOM	PROBABLE CAUSE(S)	REMEDY
Err 9.0	Internal fault	Service required.
Err 9.5	Calibration data not present.	Calibrate scale.
Err 53	EEPROM data incorrect.	Service required.
CAL E	Calibration Error. Calibration value outside allowable limits.	Repeat calibration using correct calibration weights.
LOW.rEF	The average piece weight of the parts is small (warning).	Use parts with average piece weight greater than or equal to 1 division.
REF.WT Err	The average piece weight of the parts is too small.	Use parts with a average piece weight greater than or equal to 0.1 division.

#### 7.4 Service Information

If the troubleshooting section does not resolve your problem, contact an authorized Ohaus Service Agent. For Service assistance in the United States, call toll-free 1-800-526-0659 between 8:00 AM and 5:00 PM Eastern Standard Time. An Ohaus Product Service Specialist will be available to assist you. Outside the USA, please visit our website [www.ohaus.com](http://www.ohaus.com) to locate the Ohaus office nearest you.

## 8. TECHNICAL DATA

### 8.1 Specifications

#### Materials

T31XW Housing: stainless steel

T31P Housing: ABS plastic

Keypad: polyester

Feet: Rubber

Display Window: Polycarbonate

#### Ambient conditions

The technical data is valid under the following ambient conditions:

Ambient temperature: -10°C to 40°C / 14°F to 104°F

Relative humidity: Maximum relative humidity 80% for temperatures up to 31°C decreasing linearly to 50% relative humidity at 40°C.

Height above sea level: up to 4000m

Operability is assured at ambient temperatures between -10°C. and 40°C.

**TABLE 8-1. SPECIFICATIONS**

Indicator	T31P	T31XW
Capacity Range	5 to 20000 kg or lb	
Maximum Displayed Resolution	1:10,000	
Maximum Approved Resolution	1:3,000	
Maximum Counting Resolution	1:100,000	
Weighing Units	kg, lb, g, oz, lb:oz	
Functions	Weighing, Parts Counting	
Display	1 in./2.5 cm digit height, 6-digit, 7-segment 1.5 in./3.8 cm high x 4.9 in./12.5 cm wide backlit LCD	
Backlight	White LED	
Keypad	4-button mechanical switches	4-button membrane switch
Ingress Protection	---	IP66
Load Cell Excitation Voltage	5V DC	
Load Cell Drive	Up to 4 x 350 ohm Load Cells	
Load Cell Input Sensitivity	Up to 3 mV/V	
Stabilization Time	Within 2 Seconds	
Auto-zero Tracking	Off, 0.5, 1 or 3 Divisions	
Zeroing Range	2% or 100% of Capacity	
Span Calibration	5 kg or 5 lb to 100% Capacity	
Interface	RS232	
Overall Dimensions (W x D x H) (in/mm)	8.2 x 2.8 x 6.5 / 210 x 71 x 168	8.3 x 2.8 x 5.8 / 212 x 71 x 149
Net Weight (lb/kg)	3.6 / 1.6	6.6 / 2.9
Shipping Weight (lb/kg)	5.7 / 2.6	8.8 / 4.0
Operating Temperature Range	-10°C to 40°C/14°F to 104°F	
Power	9 VDC, 0.5A, AC Adapter (T31P) 100-240 VAC / 50-60 Hz, Internal Power Supply (T31XW), Internal rechargeable, Sealed Lead-Acid Battery (100-hour typical life)	



## 8.2 Accessories

**TABLE 8-2. ACCESSORIES.**

<b>DESCRIPTION</b>	<b>PART NUMBER</b>
Column Mount Kit, 35 cm painted steel	80251743
Column Mount Kit, 70 cm painted steel	80251744
Column Mount Kit, 35 cm stainless steel	80251745
Column Mount Kit, 70 cm stainless steel	80251746
Wall Mount Kit, T31P	80251747
Wall Mount Kit, T31XW	80251748
Interface Cable/PC 25-pin, T31P	80500524
Interface Cable/PC 9-pin, T31P	80500525
Interface Cable/PC 9-pin, T31XW	80500552
Interface Cable/PC 25-pin, T31XW	80500553
Interface Cable/Printer SF42, T31P	80500571
Interface Cable/Printer SF42, T31XW	80500574
SF42 Printer	SF42

8.3 Drawings and Dimensions

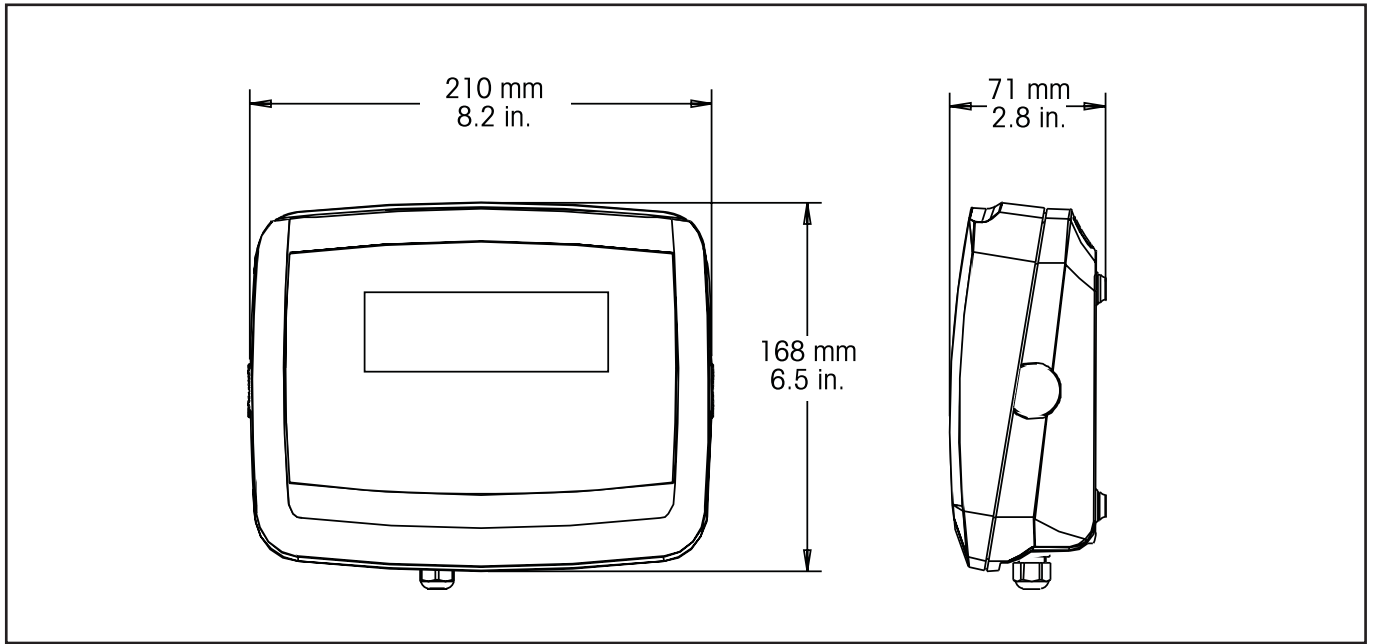

Figure 8-1. T31P Indicator Overall Dimensions.

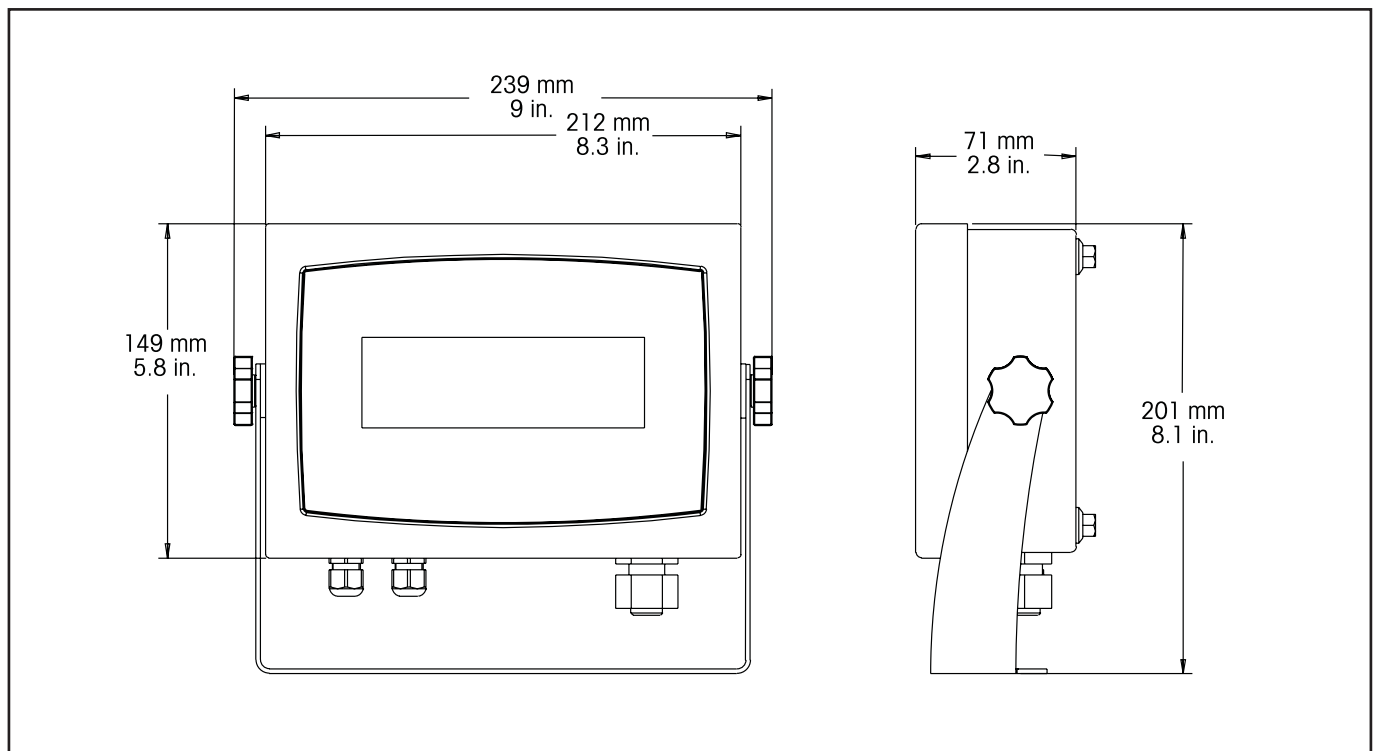

Figure 8-2. T31XW Indicator Overall Dimensions with Mounting Bracket.

## **LIMITED WARRANTY**

Ohaus products are warranted against defects in materials and workmanship from the date of delivery through the duration of the warranty period. During the warranty period Ohaus will repair, or, at its option, replace any component(s) that proves to be defective at No charge, provided that the product is returned, freight prepaid, to Ohaus.

This warranty does Not apply if the product has been damaged by accident or misuse, exposed to radioactive or corrosive materials, has foreign material penetrating to the inside of the product, or as a result of service or modification by other than Ohaus. In lieu of a properly returned warranty registration card, the warranty period shall begin on the date of shipment to the authorized dealer. No other express or implied warranty is given by Ohaus Corporation. Ohaus Corporation shall Not be liable for any consequential damages.

As warranty legislation differs from state to state and country to country, please contact Ohaus or your local Ohaus dealer for further details.



Ohaus Corporation  
19A Chapin Road  
P.O. Box 2033  
Pine Brook, NJ 07058, USA  
Tel: (973) 377-9000  
Fax: (973) 593-0359  
[www.ohaus.com](http://www.ohaus.com)



P/N 80251064 © Ohaus Corporation 2006, all rights reserved.

Printed in China



# Defender™ 3000 Series Base Instruction Manual

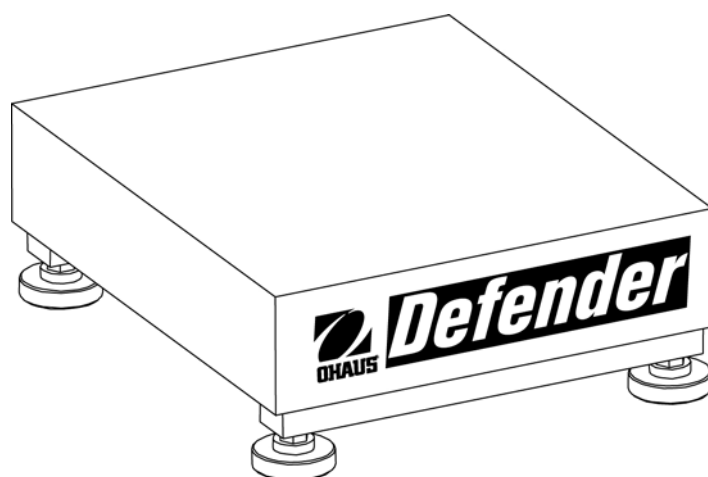

## Compliance



This product conforms to the EMC directive 89/336/EEC and the Low Voltage Directive 73/23/EEC. The complete declaration of Conformity is available from Ohaus Corporation

### Disposal

In conformance with the European Directive 2002/96 EC on Waste Electrical and Electronic Equipment (WEEE) this device may not be disposed of in domestic waste. This also applies to countries outside the EU, per their specific requirements.



Please dispose of this product in accordance with local regulations at the collecting point specified for electrical and electronic equipment.

If you have any questions, please contact the responsible authority or the distributor from which you purchased this device.

Should this device be passed on to other parties (for private or professional use), the content of this regulation must also be related.

Thank you for your contribution to environmental protection.

### ISO 9001 Registration

In 1994, Ohaus Corporation, USA, was awarded a certificate of registration to ISO 9001 by Bureau Veritas Quality International (BVQI), confirming that the Ohaus quality management system is compliant with the ISO 9001 standard's requirements. On May 15, 2003, Ohaus Corporation, USA, was re-registered to the ISO 9001:2000 standard.

## INTRODUCTION

This manual covers installation, and maintenance instructions for the Ohaus Defender™ Series Base. Please read this manual completely before installation and operation.

## SAFETY PRECAUTIONS

For safe and dependable operation of this product, please comply with the following precautions:



- Operate the base only under ambient conditions specified in these instructions
- Ensure that the load cell cable does not pose an obstruction or tripping hazard
- Do not operate the base in hazardous environments or unstable locations
- Do not drop loads on the base
- Do not lift the base by the top frame; always lift from the bottom frame when moving the base
- Service should only be performed by authorized personnel

## INSTALLATION

### Unpacking

Unpack and inspect the product to make sure that all components have been included. The package includes the following:

- Defender™ Series Base
- Weighing Pan
- Warranty Card
- Instruction Manual

When purchased as a complete Defender Series Scale, will also include:

- 3000 Series Indicator
- Column Assembly

### Assembly

### Weighing Pan

Place the weighing pan securely over the rubber load pads on the top frame of the base.

### Wiring Connections

Connect the load cell cable to an indicator using the wiring codes in Table 1 below. Refer to the indicator manual for information about load cell connections, setup and calibration.

**Note:** When purchased as a Defender Series Scale, the base is already pre-wired to the 3000 Series Indicator.

**TABLE 1. SIX WIRE LOAD CELL CONNECTION.**

FUNCTION	WIRE COLOR
+ Excitation	Green
- Excitation	Black
+ Signal	Red
- Signal	White
+ Sense	Blue
- Sense	Brown
Shield	Yellow

### Selecting the Location

To ensure accuracy, proper performance and safety, locate and operate the base on a stable, level surface. Avoid locations with rapid temperature changes or excessive dust, air currents, vibrations, electromagnetic fields or heat.

Level the base by adjusting the four leveling feet until the bubble in the level indicator (located at the rear of the base) is centered. A wrench may be needed to loosen the locking nut above each leveling foot. When the base is level, retighten the locking nuts up against the base to lock each foot into place.

**Note:** Ensure that the base is level each time its location is changed.

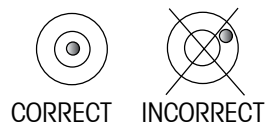

## MAINTENANCE

### Cleaning

The base components should be kept clean and free of excessive material build up.

- Damp cloth with water and a mild detergent may be used to wipe clean the external surfaces—do not use acids, alkalis, strong solvents or abrasive materials and chemicals

### Troubleshooting

Aside from installing components and leveling adjustments, the Defender Series Base does not require any other adjustments as shipped from the factory.

Operational difficulties that may be encountered can often be traced to simple causes such as:

- Loose or incorrect wiring connections
- Obstructions to the base frame
- Unstable environments
- Incorrect calibration or setup of the indicator

If the troubleshooting section does not resolve or describe your problem, contact your authorized Ohaus service agent. For service assistance or technical support in the United States call toll-free 1-800-526-0659 between 8:00 AM and 5:00 PM EST. An Ohaus product service specialist will be available to provide assistance. Outside the USA, please visit our web site, [www.ohaus.com](http://www.ohaus.com) to locate the Ohaus office nearest you.

## TECHNICAL DATA

### Technical Specifications

The technical data is valid under the following ambient conditions:

Ambient temperature: -10°C to +40 °C

Relative humidity: 10% to 90% relative humidity, non-condensing

Height above sea level: Up to 4,000m

Operability is assured at ambient temperature -10°C to +40 °C

**TABLE 2a. SPECIFICATIONS**

MODEL	D30BR	D60BR	D60BL	D150BL	D150BX	D300BX
Capacity	30 kg	60 kg	60 kg	150 kg	150 kg	300 kg
Maximum Resolution	6000d	6000d	6000d	7500d	7500d	6000d
Load Cell Capacity	50 kg	100 kg	150 kg	300 kg	300 kg	500 kg
Pan Dimensions	305 x 355 x 75 mm		420 x 550 x 80 mm		500 x 650 x 90 mm	
Base Construction	Stainless Steel platform with painted steel frame and rubber leveling feet					
Repeatability (std. deviation)	1d					
Linearity	±1d					
Load Cell Cable	2 m L x 6-wire		2.3 m L x 6-wire			
Load Cell Type	350 Ohm, aluminum, single point					
Load Cell Excitation	5-15V DC/AC					
Load Cell Rated Output	2mV/V					
Load Cell Protection	IP67					
Safe Overload Capacity	125% of capacity					
Net Weight	9 kg		16 kg		28 kg	
Shipping Weight	11 kg		19 kg		32 kg	



**TABLE 2b. SPECIFICATIONS**

<b>MODEL</b>	<b>D30VR</b>	<b>D60VR</b>	<b>D60VL</b>	<b>D150VL</b>	<b>D150VX</b>	<b>D300VX</b>
Capacity	30 kg	60 kg	60 kg	150 kg	150 kg	300 kg
Maximum Resolution	6000d	6000d	6000d	7500d	7500d	6000d
Load Cell Capacity	50 kg	100 kg	150 kg	300 kg	300 kg	500 kg
Pan Dimensions	305 x 355 x 75 mm		420 x 550 x 80 mm		500 x 650 x 90 mm	
Base Construction	Stainless Steel platform with stainless steel frame and rubber leveling feet					
Repeatability (std. deviation)	1d					
Linearity	±1d					
Load Cell Cable	2 m L x 6-wire		2.3 m L x 6-wire			
Load Cell Type	350 Ohm, stainless steel, single point					
Load Cell Excitation	5-15V DC/AC					
Load Cell Rated Output	2mV/V					
Load Cell Protection	IP67					
Safe Overload Capacity	125% of capacity					
Net Weight	9 kg		21 kg		33 kg	
Shipping Weight	11 kg		24 kg		37 kg	

Drawings

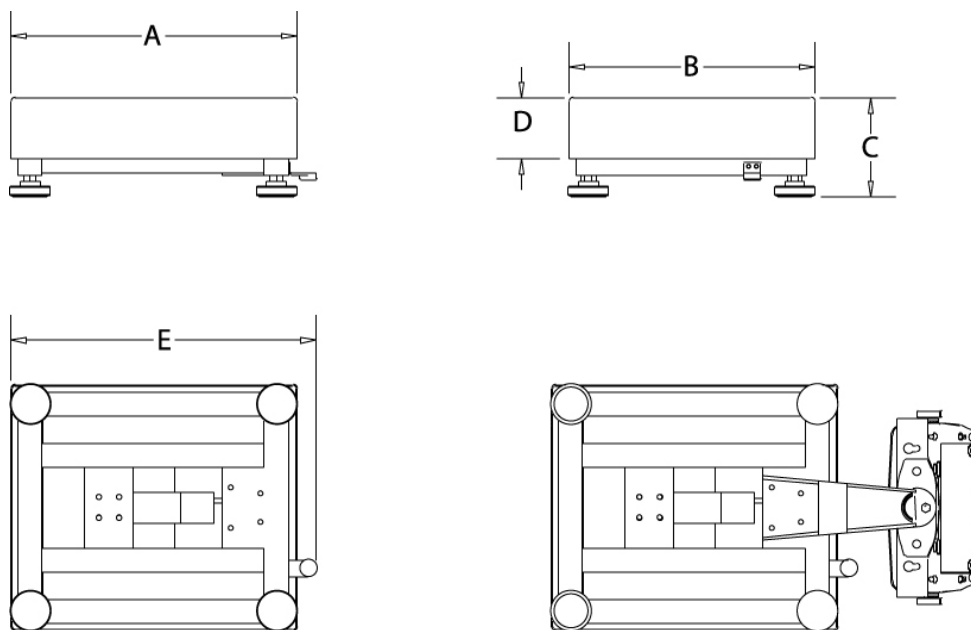

Base shown with 3000 series indicator and column

Figure 1. Defender Base Dimension Drawing.

TABLE 3. DIMENSIONS.

Base	A	B	C	D	E
	Pan Depth	Pan Width	Height of Pan to Surface of Table*	Height of Pan	Depth Including Level Indicator
D30BR, D60BR	355 mm	305 mm	123 mm	75 mm	380 mm
D60BL, D150BL	550 mm	420 mm	136 mm	80 mm	575 mm
D150BX, D300BX	650 mm	500 mm	143 mm	90 mm	675 mm
D30VR, D60VR	355 mm	305 mm	119 mm	75 mm	380 mm
D60VL, D150VL	550 mm	420 mm	145 mm	80 mm	575 mm
D150VX, D300VX	650 mm	500 mm	154 mm	90 mm	675 mm

\*For leveling purposes, the feet may be extended up to an additional 11 mm.

TABLE 4. ACCESSORIES.

Description	Part Number
Column Kit, 35 cm painted steel	80251743
Column Kit, 70 cm painted steel	80251744
Column Kit, 35 cm stainless steel	80251745
Column Kit, 70 cm stainless steel	80251746

**LIMITED WARRANTY**

Ohaus products are warranted against defects in materials and workmanship from the date of delivery through the duration of the warranty period. During the warranty period Ohaus will repair, or, at its option, replace any component(s) that proves to be defective at no charge, provided that the product is returned, freight prepaid, to Ohaus. This warranty does not apply if the product has been damaged by accident or misuse, exposed to radioactive or corrosive materials, has foreign material penetrating to the inside of the product, or as a result of service or modification by other than Ohaus. In lieu of a properly returned warranty registration card, the warranty period shall begin on the date of shipment to the authorized dealer. No other express or implied warranty is given by Ohaus Corporation. Ohaus Corporation shall not be liable for any consequential damages. As warranty legislation differs from state to state and country to country, please contact Ohaus or your local Ohaus dealer for further details.



Ohaus Corporation  
19A Chapin Road  
P.O. Box 2033  
Pine Brook, NJ 07058-2033, USA  
Tel: (973) 377-9000  
Fax: (973) 944-7177

With offices worldwide  
[www.ohaus.com](http://www.ohaus.com)



P/N 80251065 A © Ohaus Corporation 2006, all rights reserved

Printed in China